

Building Information Modeling

Yusuf Arayici



Download free books at

bookboon.com

Yusuf Arayici

Building Information Modeling



Building Information Modeling

1st edition

© 2015 Yusuf Arayici & bookboon.com

ISBN 978-87-403-1098-6

Contents

1	Introduction to BIM	9
1.1	Introduction	9
1.2	The construction industry and its challenges	10
1.3	Origins of BIM	15
1.4	So what is building information modelling?	25
1.5	Overview of requirements for UK government level 2 BIM	28
1.6	Conclusion	32
1.7	References	33
2	BIM Tools and Technologies	36
2.1	Introduction	36
2.2	CAD technologies	36
2.3	Parametric modelling technologies	37
2.4	BIM Tools	39
2.5	Review Of Major BIM Tools In The Aec Industry	44
2.6	BIM Library	51

www.sylvania.com

We do not reinvent the wheel we reinvent light.

Fascinating lighting offers an infinite spectrum of possibilities: Innovative technologies and new markets provide both opportunities and challenges. An environment in which your expertise is in high demand. Enjoy the supportive working atmosphere within our global group and benefit from international career paths. Implement sustainable ideas in close cooperation with other specialists and contribute to influencing our future. Come and join us in reinventing light every day.

Light is OSRAM

OSRAM SYLVANIA



2.7	Interoperability	54
2.8	Free BIM Tools	57
2.9	References	62
3	Process	67
3.1	Introduction	67
3.2	Uses of BIM	71
3.3	Business process re-engineering	74
3.4	Summary	91
3.5	References	92
4	BIM Technologies in the Process	94
4.1	Introduction	94
4.2	Level of development (LOD)	95
4.3	BIM Tools In The Process	97
4.4	BIM Use in the Design Phase	98
4.5	BIM uses in the Construction Phase	106
4.6	BIM Usage in the Operation Phase	114
4.7	Free BIM Tools in the Design Process	118
4.8	References	120



360°
thinking.

Deloitte.

Discover the truth at www.deloitte.ca/careers

© Deloitte & Touche LLP and affiliated entities.



5	BIM & Sustainable Design	124
5.1	Introduction	124
5.2	Building design and sustainability awareness	124
5.3	Sustainable design	127
5.4	Principles of sustainable design	129
5.5	Benefits of sustainable building design	131
5.6	Key challenges in sustainable design	133
5.7	How BIM contributes to sustainable design	135
5.8	An experimental BIM process for sustainable design	140
5.9	Limitations in using BIM for sustainability	144
5.10	Conclusion	144
5.11	References	145
6	BIM and Construction Management	149
6.1	Introduction	149
6.2	Background – construction project management	150
6.3	BIM as a Way Forward for Better Construction Management	157
6.4	Conclusion	164
6.5	References	165

SIMPLY CLEVER

ŠKODA



We will turn your CV into an opportunity of a lifetime



Do you like cars? Would you like to be a part of a successful brand? We will appreciate and reward both your enthusiasm and talent. Send us your CV. You will be surprised where it can take you.

Send us your CV on www.employerforlife.com



7	BIM for Facilities Management and Building Maintenance	168
7.1	Introduction	168
7.2	Level of developments at key project stages	168
7.3	The Value Of Information Beyond Construction	171
7.4	Facilities Management	176
7.5	BIM for Facilities Management	177
7.6	Strategies for Model Maintenance	182
7.7	Applying Government Soft Landings (GSL) Policy	182
7.8	Initiating Employers' Information Requirements (EIR)	183
7.9	Producing a BIM Execution Plan (BEP)	184
7.10	Involving FM in Common Data Environment (CDE)	185
7.11	Technologies for Model Maintenance	185
7.12	Conclusions	192
7.13	References	193

I joined MITAS because
I wanted **real responsibility**

The Graduate Programme
for Engineers and Geoscientists
www.discovermitas.com



Month 16

I was a construction supervisor in the North Sea advising and helping foremen solve problems

Real work
International opportunities
Three work placements







8	Benefits and Challenges	196
8.1	Introduction	196
8.2	Benefits and challenges of BIM	197
8.3	A review of the report “rethinking construction”	206
8.4	UK government’s vision for construction industry by 2025	212
8.5	Barriers to BIM implementation	214
8.6	References	219
9	Case Studies	222
9.1	Introduction	222
9.2	Case Study 1: A School Project in North-West UK	222
9.3	Case Study 2 – A Leisure Facility in North-East UK	223
9.4	Case Study 3 – A Campus Building Project	226
9.5	Case Study 4: A University Campus Building Project	230
9.6	Elaboration of BIM Usage in the Case Studies	232
9.7	Disadvantages of BIM Use in the Case Studies	237
9.8	Advantages of BIM Use in the Case Studies	238
9.9	Analysis of BIM Usage for the Project Management of Relocation to MediaCity Case Study	240
9.10	References	261

1 Introduction to BIM

1.1 Introduction

Control of time, cost and waste is of paramount concern to all parties involved in construction projects. Many problems relating to issues of control result from the inadequate communication of information within contracting organisations or amongst contracting and other design organisations. The amount of information involved in any construction project from start to finish should not be underestimated. At any particular stage of the project, different types of information are required by various people in various formats. For example, in large industrial projects it has been revealed that more than 50% of site construction problems are attributed to design or communication of the design and more than 50% of contract modifications are related to design deficiencies. This suggests the need for early efforts by all participants to identify and resolve potential problems ensuring delivery of complete and correct design and construction documents.

During the last two decades, construction companies have adopted functionally-based IT systems in an attempt to support the increasing demands for business efficiency, productivity, quality and competition. Over this period, the nature of these technologies has changed. Where once the use of IT systems was largely restricted to specific functions, a new generation of integrated IT systems have emerged which have new implications throughout the organisation. Because of the high cost of these advanced technologies, together with their complexity and novelty, organisations have limited experience of using them in an effective way or integrating them with their business. As a result, attention has been focused solely on the technical development and installation of IT systems and facilities.

The expected benefits originally sought have not been realised. The root cause of this failure has been attributed to insufficient account being taken of the relationships between these technologies and the business and organisational context in which they are located. These fundamental problems are frequently experienced and reported in the introduction and implementation of integrated IT systems.

This chapter reviews the construction industry and its challenges and the problems within its traditional practices (which include problems relating to integration and communications) and examines the relationship between the implementation of technologies and business environments. Problems relating to management, management of change, IT systems and investments are discussed with the aim of building a complete picture of the requirements for the successful implementation of advanced technologies. This critical review of industry problems will then lead to a discussion about the emergence of BIM as a CIC (Computer Integrated Construction) concept. This is then followed by a comprehensive definition of what BIM is and then finally the chapter provides an overview on government strategies for the implementation of BIM at maturity level 2 in public property projects in the UK.

1.2 The construction industry and its challenges

The construction industry is a traditional sector, as old as mankind's history; multi-faceted with the involvement many stakeholders; and complicated with many uncertainties and ambiguities throughout its lifecycle incorporating design, construction, operation and demolition phases. For example, taking into consideration the design process solely within the building lifecycle process, in the majority of construction procurement systems, design work needs to be completed in a multidisciplinary teamwork environment. The design process is by nature illusive and iterative within the same discipline, and between the different AEC disciplines. During the development of the design, several problems relating to data acquisition and management, in addition to multi- and inter-disciplinary collaboration, can arise. Often design team members, even from the same discipline, use different software tools and work in parallel, for example, a building can be divided into three different sections given to three different architects to design. These architects may each use a different software tool and thus there is a need to incorporate their work together at the end of the design process (Nour, 2007). When considering the whole construction lifecycle (including the design process) the complexity, uncertainty and ambiguity will increase. Traditionally, construction companies have not fully perceived the importance of increasing the dynamism and complexity of its external environment. This could be attributed to the special and complicated nature of the industry and could also be due to a lack of a long term co-operative strategic thinking.

This section will elaborate the underlying reasons for this complexity, uncertainty and ambiguity.

1.2.1 Information Acquisition – The Nature of Information and its Flow

The construction industry is highly dependent on gathering and presenting information in a useful and logical manner. This process is costly and time consuming, especially if information is to be presented in a consistent manner. Nevertheless, the successful manipulation of information will give a company competitive advantage and improve the services provided to clients. In a dynamic environment like construction, information manipulation cannot be effectively undertaken by manual means and the automation of certain areas in the process which can provide critical information for an organisation is of great advantage. Information needs to be managed electronically so that it can be summarised, queried, and presented at any required level of detail with minimum effort.

Construction projects consist of many interrelated processes and sub-processes, often carried out by different professionals at different locations. Most of the tasks involved in construction processes mainly concern exchanging information between project stakeholders. The majority of construction research has addressed the need to improve the poor cross-disciplinary communications, which, in turn, would lead to an improvement in the efficiency and the effectiveness of the construction processes.

One of the main challenges of the construction industry is the high fragmentation within its supply chain. However, despite the increasing trend towards multi-disciplinary practical arrangements between construction firms (such as partnering), the construction industry still consists of hundreds of small and medium size firms that offer undifferentiated products and services. In addition, the project stakeholders perform numerous tasks and activities that involve the extensive use of diverse information and complex relationships.

The lack of standardisation and commonality provided by the existing environment limits the ability of construction organisations to capture, communicate and share large amounts of information about construction projects among the IT facilities used by a project's participants. This has encouraged some construction companies to work towards a positive shift in the culture and has provided a foundation for the support of a co-operative process.

Future interactions between the different professions in the construction industry will be highly influenced by the successful implementation of integrated IT systems, formerly called Computer Integrated Construction (CIC) and, contemporarily, it is called Building Information Modelling (BIM) which can provide:

- A dynamic base of information
- Quality assurance
- Management orientated value added services
- Advanced information and communications
- Progression towards integrated practices.

1.2.2 Information Management in the Construction Industry

Despite the importance of information management, it has not been properly or sufficiently addressed within the industry. Storage of information is undertaken either on paper and/or computer with little or no linkage. Quickly accessing comprehensive information at the right time is very difficult to achieve and this has led professional institutions to stress the need for quality assurance procedures which could assist in creating an organised pool of information. Electronic management of information through the use of IT is the most effective way of manipulating information allowing users/managers to store and retrieve information easily, gain faster, complete and accurate responses, and to be better informed of the relevant issues.

Information can be classified, according to its usage, into two types: operational and managerial. Operational information is concerned with the daily running of a practice while managerial information is used by management to make accurate decisions. At the operational level, automation has been applied effectively and on a large scale to tasks such as estimating, planning and preparing the Bill of Quantities. However, such applications are hardly based on an integrated approach and create ‘islands of automation’ (figure 1.1). On the managerial level, where information is of high value to a practice, automation is rarely considered. This is because management frequently seeks tangible benefits and is not prepared to consider intangible ones.

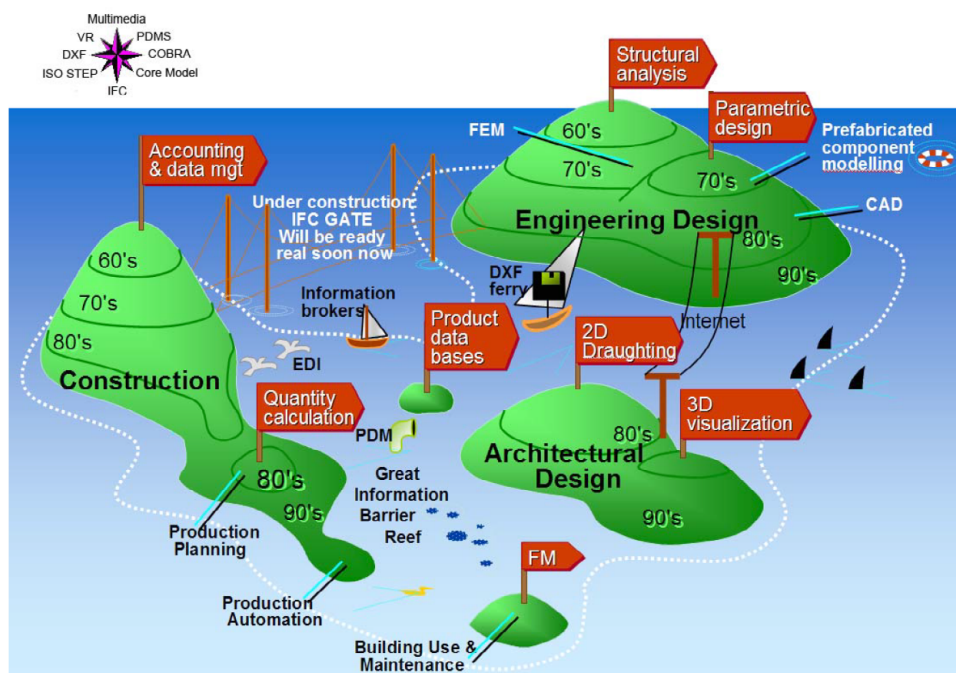

Figure 1.1: Islands of Automation historically existing in the AEC industries (Hannus 1998; Isikdag et al., 2009)

1.2.3 Classic Problems of the Construction Industry

This section addresses the problems which relate to poor communication between construction professionals, highlighting the main causes. Poor management can be one important contributor to this problem while people themselves may resist changes to any new improvement. Technology itself can also be an obstacle to information transfer and may be as a result of bad investment in IT.

1.2.3.1 Management – Lack of Long-Term Strategic Management Thinking

The absence of sophisticated management techniques and methods is a dominant issue within common practices in the construction industry. Much research has highlighted the coherent lack of management expertise and the poor applications of strategic management in the construction industry, for example, integration is about communication and in the construction industry it is often left to technologists to deal with its associated problems.

Commitment by top management is essential to the success of integrated systems and undertaking the implementation of such systems is a major decision for any construction company. Such commitment has implications for many areas throughout the organisation, design, engineering, production, purchasing and so on.

It is clear that if construction companies are to gain from the potential benefits of introducing integrated systems, management must provide a controlled and favourable environment. There must be full and enthusiastic involvement by all stakeholders to ensure that the information is available in a consistent, accurate and timely manner. According to a number of construction organisations, the underlying causes of problems in the adoption and utilisation of integrated IT systems can be attributed to the following:

- Poor management and communication
- Inadequate technical expertise
- A lack of software availability
- The fragmented nature of the industry
- A lack of standardisation and uniform procedures
- The number of stakeholders involved in construction projects
- The costs of implementation

ie business school

#1 EUROPEAN BUSINESS SCHOOL
FINANCIAL TIMES 2013

#gobeyond

MASTER IN MANAGEMENT

Because achieving your dreams is your greatest challenge. IE Business School's Master in Management taught in English, Spanish or bilingually, trains young high performance professionals at the beginning of their career through an innovative and stimulating program that will help them reach their full potential.

- Choose your area of specialization.
- Customize your master through the different options offered.
- Global Immersion Weeks in locations such as London, Silicon Valley or Shanghai.

Because you change, we change with you.

www.ie.edu/master-management | mim.admissions@ie.edu |

Download free eBooks at bookboon.com



Click on the ad to read more

1.2.3.2 Change management – Resisting the *Culture of the Industry*

Although not expressed openly, resistance to change, for example, to the implementation and utilisation of integrated technologies by construction professionals, often slows down the rate of progress in the adoption of sophisticated IT systems. This is made worse by the fragmented nature of the industry and the number of stakeholders involved. The reasons for resisting change often include a desire not to lose the existing IT applications because of their familiarity and a belief that the change does not make any sense for the company. There is clear evidence that the level of resistance to change has an indirect relationship with the level of IT skills in construction organisations and a direct relationship with the degree of complexity of the proposed systems.

1.2.3.3 IT Facilities – Lack of Interoperability and Incompatibility

Computers of today are faster, smaller, easier to use and more intelligent than those of only a few years ago. They are able to store and process data, text, voices, videos and images as well as graphics. All these technological developments provide construction organisations with new ways to compete. However, success in the progress of IT in the construction industry relies on the ability to exchange and share information among the project stakeholders, using appropriate IT links. This, in turn, depends on common standards and approaches. The utilisation of function-based systems such as design, estimating, scheduling, costing and integrated IT systems are often influenced by their commercial availability or in-house development. The growing complexity of, and the information processing needs of, construction companies and the benefits of 'one-stop-shopping' encourages construction organisations to take advantage of using a single vendor but a lack of compatibility with other systems is limiting the potential benefits of the technology. This issue will become critical when the need for sharing information is extended from a local to a national and global scale. The following examples are some of the typical problems reported by different companies.

1.2.3.4 IT investment – Lack of Standardisation

Information Technology has significantly contributed to the management of information, business efficiency and competitive advantages in construction companies. However, the progress of IT, to some extent, depends on the evaluation of IT projects and investments. Therefore, an appreciation of the costs and the intangible benefits of IT investments has become a major issue for senior IT professionals.

Construction organisations use different cost accounting systems to measure how well the company is doing. Investment in IT and integrated technologies is usually represented as a cost, not a benefit. As a result, the value added properties of integrated systems to construction projects is not fully appreciated. This influences the level of investment in IT which, in turn, hinders progress towards standardisation. In small construction organisations, the problem may be much greater, due to the unavailability of initial investments. A view was expressed by a number of construction companies that, locally, this has a serious implication for the survival of small companies and, in the long run, it would delay the advancement of IT in the construction industry in terms of standardisation.

1.3 Origins of BIM

Corporations today are becoming largely distributed and deeply founded on networking technology which allows for the sharing and accessing of information in different locations. Meanwhile, computer based information systems have become the spinal chord of modern enterprises and new appropriate information tools satisfying fast reactive business requirements have been emerging such as Building Information Modelling (BIM) systems.

Concepts such as ‘virtual enterprises’ which bind a fragmented and geographically spread set of partners collaborating together has become popular since 1990s as well as stimulated discussions, and research and development for the elaboration of new powerful frameworks to support business models.

CIC (Computer Integrated Construction) as a concept inspired by Computer Integrated Manufacturing (CIM) is a specific example of virtual enterprises for the construction industry as it aims to bind a fragmented and geographically spread set of construction stakeholders collaborating together through the supply chain. It was sometimes called Building Product Models (BDP). However, contemporarily, it is called Building Information Modelling. This is a term which originally emerged in the USA in mid 2000s and many CAD software vendors have promote their parametric modelling tools as BIM tools such as Revit, ArchiCAD and Allplan. Although the vendors’ promotion of the concept of BIM helped to increase awareness and the commonality of BIM, it also resulted in false understandings and interpretations of what BIM actually is amongst construction professionals. Furthermore, recent market and political pressures on the construction industry have led to a paradigm shift to ? (i) increase: productivity, efficiency, infrastructure value, quality and sustainability, and (ii) reduce: lifecycle costs, lead times and duplications, via the effective collaboration and communication of stakeholders in construction projects with a focus on the creation and reuse of consistent digital information by the stakeholders throughout the lifecycle.

Therefore, it would be useful if the CIC concept is elaborated in detail in order to explain the origin of BIM and to produce a correct definition of what BIM actually is. The concept of CIC has been the subject of research for many years. The rationale for CIC research was, as mentioned in the previous section, that poor cross-disciplinary communications and the special nature of the industry and its supply chain have been regarded as the main bottleneck for any further improvements in construction industry performance.

It was widely realised that the construction industry has much in common with the manufacturing industries. Thus, construction research started to look at the construction industry from the perspectives of successful models which have been applied previously in manufacturing. Computer Integrated Manufacturing (CIM) has been presented as a key for integration in manufacturing. CIM has led to the notion of Computer Integrated Construction (CIC). The very basic premise of CIC is that it allows different project participants to share project information by either accessing a central database or by exchanging information electronically.

Background research in construction shows that integration has been addressed in a variety of ways: communication between applications, integration through geometry, knowledge based interfaces linking multiple application and multiple databases, and integration through central databases holding all the information relating to a project according to a common infrastructure. Earlier efforts in the area of integration and in the use of IT in construction have led to several advances in the fields of Data Exchange Standards which have been reflected in many research projects including IFCs, BuildingSmart (formerly IAI), CORBA and STEP.

Several prototype applications, addressing the integrated project data model and the implementation of an integrated project database, emerged including ATLAS (Greening and Edwards, 1995), OSCON (Aouad, 1997), GALLICON (Aouad et al., 2001), WISPER (Faraj et al., 1999), SPACE (Alshawi et al., 1996), VBE (Bazjanac, 2004), DIVERCITY (Arayici and Aouad, 2004), FIDE (Molina and Martinez, 2004), MOBIKO (Steinmann, 2004), PAMPER (Szigeti and Davis, 2003), BLIS (Laiserin, 2003), nD Modelling (Aouad et al., 2005) and many others.

However, a drawback in some of these previous research efforts is that ICT technologies were used to 'sit in the driver's seat' and steer partial model exchange scenarios. However, there is a great need to understand the connections that can be made to a larger context, whereby the end user's value chain requirements and procurement systems' demands are the driving factors, i.e. research efforts should be driven by end users' needs rather than ICT solutions.



"I studied English for 16 years but...
...I finally learned to speak it in just six lessons"
Jane, Chinese architect

ENGLISH OUT THERE

Click to hear me talking before and after my unique course download



1.3.1 Semantic Product Models

There is a need to understand and document the form of data. This requirement is typical of any information system development and is usually addressed by the creation of a model of the relevant data and the activities. One category of model in the development of CIM or CIC systems is the Product Model. This model is usually intended to define the various forms of data that are generated through the product lifecycle from specification through design to manufacture. It might be more properly described as a Product Data Model. In the wider context of general information systems' developments, a number of research groups have developed data models and data modelling methodologies which have extended beyond the capabilities of traditional database models (network, hierarchical, relational). These models have come to be known as Semantic Data Models. The following characteristics listed below are fundamental to semantic data models:

- Unstructured Objects
- Relationships
- Abstractions
 - Classification
 - Generalisation
 - Aggregation
 - Association
- Networks or Hierarchies
- Derivation/Inheritance
- Insertion/Deletion/Modification Constraints
- Degree of Expression of Relationship Semantics
- Dynamic Modelling

1.3.1.1 Parameterization

The requirements of manufacturing and construction have led to the development of catalogues of standard parts such as windows, doors, walls, roof, stairs etc. These are often grouped into families where a set of parts is described by varying the values of a number of parameters. Similar concepts arise in a number of technologies used in design. The constructive solid geometry approach to solid modelling uses primitives that are readily parameterized. Other research and developments aim at designing by features, whereby a set of standard features are developed, often with associated manufacturing instructions, for example, a library of manufacturing features, such as holes and slots, are provided with the software, enabling designers to select features rather than geometric primitives.

1.3.2 Information Sharing and Exchange

There is always a requirement for support tools to capture, in some way, the designer's intentions, going beyond a bland statement of shape and material. One of the aims of capturing that additional meaning is to prevent changes being made later in the product lifecycle and thus negating or lessening the value of particular design features.

Sharing enables the same instance to be used at multiple points in the structure. The designer can, therefore, augment the basic semantics provided by the product model. To take a simple example, where two objects are fitted together by means of a pipe join, the outer-diameter of one must match the inner-diameter of the other. If the common value is shared between both parts, a change made to either diameter will also apply to the other. Thus the designer's intention that the two parts should fit together is preserved.

STEP (Standard for the Exchange of Product Model Data) provides a representation of product information along with the necessary mechanisms and definitions to enable product data to be exchanged. The exchange is between different computer systems and environments associated with the complete product lifecycle, including design, manufacture and maintenance. The information generated about a product during these processes is used for many purposes. It may involve many computer systems, including some located in different organisations. To support such uses, organisations must be able to represent their product information in a common computer-interpretable form that remains complete and consistent when exchanged among different computer systems.

Neutral files offer a partial solution but they have a number of limitations, including:

- Poor specifications as their definitions are not based on information modelling methodologies. This can lead to mis-interpretations.
- A lack of conformance clauses and independent testing laboratories.
- Many mathematical representations (e.g. many representations for a line).
- Vendors defining their own sub-sets or version of the file.
- They are not comprehensive in their coverage (many address only geometry).

The purpose of STEP is the creation of a standard that enables the capture of information comprising a computerised a product model in a neutral form without loss of completeness and integrity, throughout the lifecycle of the product.

STEP aims at being complete (coverage and archiving), extendable, efficient, compatible with other standards, independent from a computing environment, better than today's solutions with minimum redundancy, at being a logical classification, and as having implementation validated through conformance testing and unambiguous definitions.

1.3.2.1 IFC (Industry Foundation Classes) Product Model

IFC aims to provide a method for information sharing in the building industry. It supplies a common language for defining a building project. Using object-oriented and component software technologies, IFC provides customisable industry-based objects that encapsulate information about building elements as well as design, construction, and management concepts. It is claimed that one of the important differences between IFC and existing data exchange standards, both open and proprietary, is that IFC will capture the relationships between building elements. This makes IFC objects act intelligently and will help capture the design intent at each stage of the building process. It should be noted that only very limited intelligence will be incorporated, as usually the behaviour of objects is defined by the applications.

The fundamental structure for the IFC model is aligned with that of the BCCM (Building Construction Core Model) of STEP (Standard for the Exchange of Product Model Data). This structure, as in STEP, consists of four main categories:

- **Products:** These parts of the model include most of the entities that can be found in a project. It includes the building, spaces, walls, doors, windows and equipment.
- **Processes:** Processes capture information on the processes associated with design, construction and management of the project.
- **Resources:** Resources define all the consumables required by the processes.
- **Control:** Control defines the constraints that need to be applied on the product, resources and processes. This will include architectural programme information, a design grid and other constraints.

The IFC product model can be sub-classified into:

- **IfcSiteObject** which can be either **IfcSiteComplex** or **IfcSite**,
- **IfcSiteComplex** which is a collection of **IfcSite**,
- **IfcSite** which represents zero or many buildings
- **IfcBuildingObject** which deals with the kind of things required to construct and furnish the building
- **IfcElement** which represents all the elements which define the building and includes spaces assembled elements and manufactured elements.

Each part of the IFC product model has been sub-classified, further improved and extended towards Facilities Management tasks too through continuous versioning and improvements.

1.3.2.2 BuildingSmart, Formerly International Alliance for Interoperability (IAI)

The International Alliance for Interoperability (IAI) is an open, membership-by-subscription body. Its objective is to promote the development and use of applications for the exchange and sharing of information to improve the efficiency and quality of building design, construction and maintenance.

The IAI was established in September 1995 in the United States and chapters have been set up in Germany, the UK, Japan, Singapore, France, Italy and the Nordic countries. The individual chapters have a Board of Management and are represented on an international co-ordinated council. IFC (Industry Foundation Classes) is an initiative of the International Alliance for Interoperability. It is an association of leading A/E/C industry companies that includes manufacturers, design firms, construction companies, building owners and software companies. Its purpose is to bring the benefits of interpretable software and intelligent building objects to all players in the building industry.

Excellent Economics and Business programmes at:



university of
 groningen



**“The perfect start
of a successful,
international career.”**

CLICK HERE
to discover why both socially
and academically the University
of Groningen is one of the best
places for a student to be

www.rug.nl/feb/education



1.3.3 Distributed Applications

Until recently, mainframe computer systems were dominant in organisations. At best, employees had a dumb terminal on their desk. All applications used to reside on a central server and were accessed by individuals thus making data management easier. However, the advances that have been made in the computer industry (hardware and software) have made computers affordable by the majority. Today, it is not uncommon to see a computer on every desk of the organisation, linked together into a network. Through gateways, the communication can be global. Now different users can run different applications on different hosts. Networks enable applications to exchange data information. For example, a designer might generate a design using a Macintosh PC in New York; design analysis might be carried out in London, UK, while the construction site might be in Tokyo, Japan. Where the information resides is not the responsibility of the users. The system itself should control the information management.

The central core (with which applications can interact) can exist on one machine and other applications that run on a remote site can exchange information, for example, a CAD drawing is generated in Manchester, the client in London can view the virtual reality model of the design without moving from the London office. This is achieved as follows:

- The virtual reality application sends a request to the central core to supply the virtual reality view of the data.
- The central core then generates the required data informing the application where the data exists.

1.3.4 Network Based Integration for a Streamlined Supply Chain

This section addresses the issue of integration and elaborates on a strategic framework for establishing Computer Integrated Construction (CIC). In the previous sections, the characteristics fundamental to semantic data models and how the general principles have been applied to specific models by STEP and IAI (BuildingSmart) have been discussed.

An integration framework acts as the backbone of the project data model. Its purpose is to integrate various construction applications into one integrated construction environment where stakeholders work in harmony throughout the supply chain. The integrated environment enables the orchestration through design, construction and the operational processes of the building lifecycle.

The representation of the project lifecycle is not an easy task and may involve a number of experts, for example architects, construction planners and site layout planners working on different areas. Therefore, it is useful to segment the data into a number of models where each is concerned with a particular stage of the project lifecycle. This enables individual experts to work separately and makes easier the data management of the environment.

The framework of the project data model will enable these data models to be tested at any stage of the development to highlight problems of inconsistencies and data duplication. A mechanism must exist that would enable the project model to request data from the specific models and vice-versa. This mechanism may take many forms depending on the tools of implementation.

Each application specific model provides a structure which contains all the data and the relationships between the data in order to perform the task required by the application it is serving. This data can be shared by other data models. Construction applications, interfacing with the data models, obtain data from the instances of these data models, i.e. once there is enough information to enable these applications to perform the required task. Applications can be part of the database internally, or they may exist outside and be interfaced with it.

A user interface to the CIC will assist in populating the data models with data knowledge and the constraints associated with a particular project. It also enables the user to interact with both the project and the applications specific mode.



American online
LIGS University
is currently enrolling in the
Interactive Online **BBA, MBA, MSc,**
DBA and PhD programs:

- ▶ enroll **by September 30th, 2014** and
- ▶ **save up to 16%** on the tuition!
- ▶ pay in 10 installments / 2 years
- ▶ Interactive **Online education**
- ▶ visit www.ligsuniversity.com to find out more!

Note: LIGS University is not accredited by any nationally recognized accrediting agency listed by the US Secretary of Education. More info [here](#).



1.3.5 Views on the Implementation of CIC (early prototypes of BIM)

A consensus emerged on the subject of integration as a proposed solution which has been strongly praised by research communities and construction practitioners. The integration research can be divided into three main categories according to the breadth and depth of the process and data integration:

- 1) Electronic document management systems
- 2) Inter-operating autonomous systems
- 3) Fully integrated concurrent engineering systems

Facing an increasing complexity of product development alongside intensifying market competition, Virtual Enterprise (VE) has appeared as a necessity within nearly all industrial fields. Even large enterprises are no longer able to design and produce all the different parts of a product, due to time constraints and a lack of some widely required specific expertise inside the enterprises.

All these factors indicate that there is a crucial demand in the construction industry for CIC solutions. This is because CIC solutions enable the management of software incompatible applications running on heterogeneous platforms, data exchange and interoperability mechanisms between applications managing different types of information with different levels of performance and functionality, together with a powerful means of communication between distant applications. This could lead to more agile production in an industry (such as the construction industry) characterised particularly by a large number of SMEs, together with a large group of small businesses.

Over the last two decades, there have been many indications of the increasing use of computer science and IT applications in construction firms. However, the evolution of computer science and advanced technologies in the construction industry has been much slower than within other manufacturing and servicing industries. Much previous research has addressed the types and ways of achieving integration from a technological point of view. These efforts have led to the development of several technical solutions for integration strategies.

However, little attention has been paid to the implementation issues of these technologies until recently. The effective uptake of such advanced technology is not a straightforward process. In the first instance, it might seem that large investments in IT could bring about benefits to its investors, which is not always actually true. On the contrary, previous experience and studies have shown that technology push system development and implementation is not sufficient to improve the efficiency and effectiveness of work environments without a clear consideration of business processes and user related issues.

Process improvement and modelling have been associated with a number of ideas concerned with the dynamic behaviour of organisations, businesses or systems more generally. Process models constructed from some viewpoint can form the basis for computer systems used to support particular behaviours for an organisation. Therefore, process-based CIC systems are more likely to be successful in meeting an organisation's need and requirements and are able to introduce overall improvements to the business environment.

The earlier approach to CIC development has been technologically driven. The “Push strategy” is the most dominant pattern for IT procurement in the construction industry. That has led to a large reported number of failures in utilising CIC which is due to the insensitivity of these systems to organisational design, external environment, and culture and management systems. Therefore, there have always been gaps between the underlining philosophy of IT and the environment in which it is implemented.

Strategic exploitation of IT in the construction industry will be achieved through transferring these solutions into practical uses, based on social process and a strategic business point of view, not just from merely a technological point of view. It is noted that failing to strategically utilise and implement advanced technological solutions in the construction industry could be attributed to the fact that the same techniques and methods, which were developed in other industries, have been applied without enough studies to check their fit to the construction industry. The implementation of integrated VR technologies should, therefore, follow an agreed methodological plan and processes which take on board the different dimensions of construction organisations for implementing and developing integrated VR technologies. The early research prototypes of BIM (CICs) had some drawbacks from the technological point of view, as indicated below.

- Homogeneity: Solutions are fixed and not open, and lack of support for the legacy systems, new systems in terms of hardware, software, databases and networks.
- High Entry Level: Solutions are often too expensive to be employed by SMEs. There needs to be more entry levels, e.g. cheap personal options to costly enterprise editions.
- Lack of Scalability: Limited growth path in terms of hardware and software.
- Application Centric: Need to organise the enterprise around the application.
- Fixed Infrastructure: Need for leased lines between partners, restricting location independence and requiring long-term relationships.
- Lack of Support for Business Processes: Limited security and transactional support.

To enable CIC by providing the ability to transact business processes seamlessly and to capture access and assess the state of the business/project and industry needs, the following are required:

- Low level entry
- Scalability
- Open Infrastructure & location independent access
- Enterprise information (i.e. seamless capturing of the state of business from the distributed legacy data)
- Support for business processes
- Security and transactional support

1.4 So what is building information modelling?

While there are a few definitions available for BIM in the literature such as are illustrated in figure 1.2 below, a correct and comprehensive definition derived from the knowledge in the previous sections can be made to give the reader a clear understanding of the real agenda of BIM.



.....Alcatel-Lucent 

www.alcatel-lucent.com/careers

What if you could build your future and create the future?

One generation's transformation is the next's status quo. In the near future, people may soon think it's strange that devices ever had to be "plugged in." To obtain that status, there needs to be "The Shift".



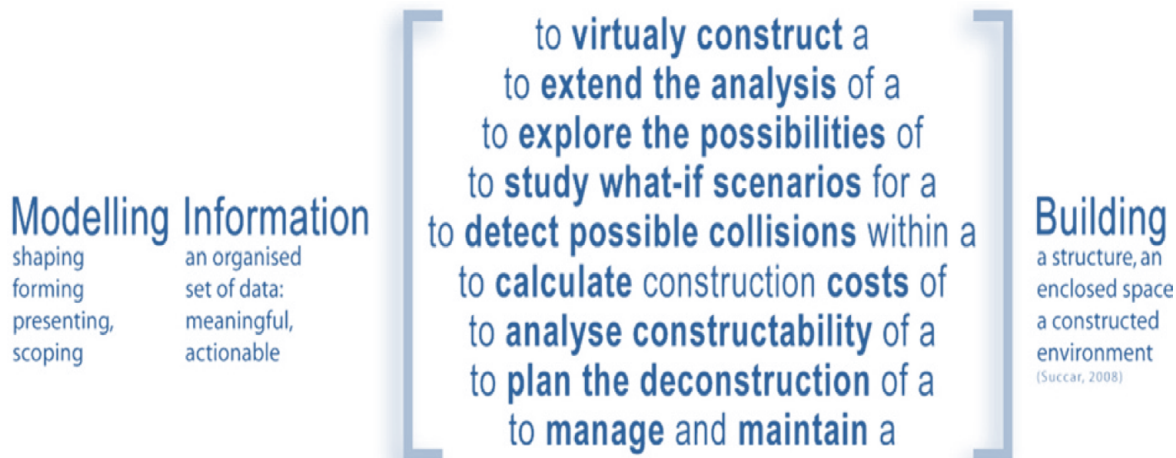

Figure 1.2: Words describing Building, Information and Modelling (Succar, 2009)

Therefore, a deliberation on the natural environment, user environment and owner satisfaction throughout the lifecycle is given within this definition:

“BIM is defined as the use of ICT technologies to streamline the building lifecycle processes in order to provide a safer and more productive environment for its occupants, to affect the least possible environmental impact from its existence, and to be more operationally efficient for its owners throughout the building lifecycle.”

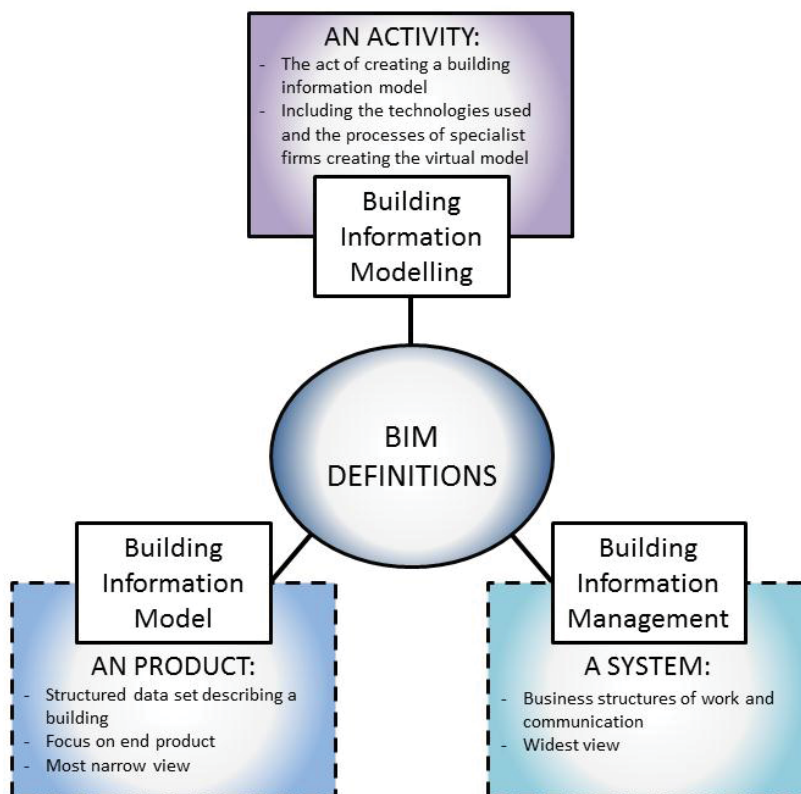

Figure 1.3: Different ways of looking at BIM (Maunula, 2008)

BIM, in most simple terms, is the utilization of a database infrastructure to encapsulate built facilities with the specific viewpoints of stakeholders. It is a methodology to integrate digital descriptions of all the building objects and their relationships to others in a precise manner, so that stakeholders can query, simulate and estimate activities and their effects of the building process as a lifecycle entity. Therefore, BIM can provide the required valued judgments that create more sustainable infrastructures which can satisfy their owners and occupants. However, it is necessary to realize that while the users and owners can change over the lifecycle of a building within different intervals the most important aspect is to minimize the impact to the natural environment. Although this can be achieved in a variety of ways using matured BIM integrated construction methodologies they are not discussed here due to our specific focus on construction lifecycle management.

BIM as a lifecycle evaluation concept seeks to integrate processes throughout the entire lifecycle of a construction project. The focus is to create and reuse consistent digital information by the stakeholders throughout the lifecycle (figure 1.4). BIM incorporates a methodology based around the notion of collaboration between stakeholders using ICT to exchange valuable information throughout the lifecycle. Such collaboration is seen as the answer to the fragmentation that exists within the building industry which has caused various inefficiencies. Although BIM is not the salvation of the construction industry, much effort has gone into addressing these issues that have remained unattended for far too long.

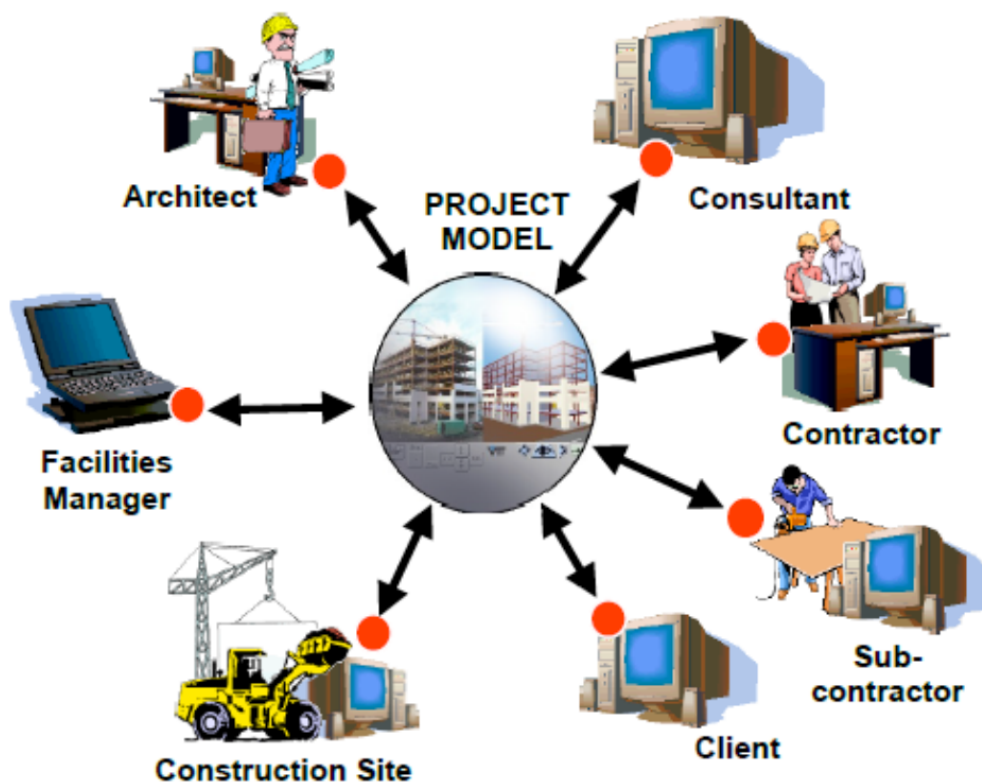

Figure 1.4: Communication and collaboration utilising BIM modelling (Aouad & Arayici, 2010)

1.5 Overview of requirements for UK government level 2 BIM

The UK government has mandated that public projects should have reached Level 2 BIM use by 2016 through a Push-Pull Strategy which supports adopting a push strategy from the supply side of the industry to enable all players to reach a minimum performance in the area of BIM use in five years, and also supports adopting a pull strategy from the client side to specify, collect and use the derived information in a value adding way over a similiar timescale. However, what Level 2 BIM means is unclear for many while there is also a lack of knowledge of, and/or a misunderstanding of, what BIM is in the construction industry. Thus, the previous section put forward a comprehensive definition of BIM based on the original concept development research concerning BIM, formerly called CIC (Computer Integrated Construction). And this section will now attempt to explain the Level 2 BIM mandated by the UK Government.

Considering that the government approach to the BIM levels illustrated figure 1.5 can be complicated (with its standards and specifications) for many people, the concise BIM maturity stages proposed by Succar (2009) and Khosrowshahi and Arayici (2012) according to the BIM theoretical concept elaborated in section 3 is put forward, believing that these will help the reader better appreciate the government’s approach to the BIM levels. To systematically analyse and understand BIM, Succar and Khosrowshshi & Arayici identified the BIM maturity stages by subdividing them into their components, which are also referred to in sections 3.1, 3.2 3.3 and 3.4 under the Origins of BIM heading. As depicted in Figure 1.5, there are three stages in the BIM implementation.

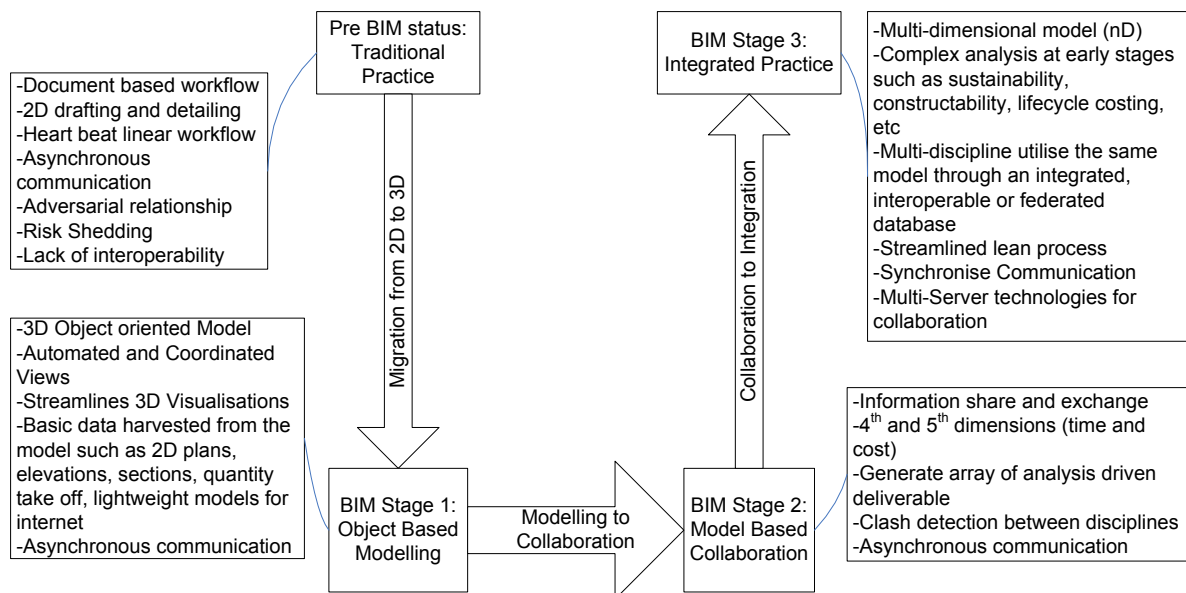

Figure 1.5: BIM Maturity Stages (Khosrowshahi & Arayici, 2012)

- Stage 1: object-based modelling
- Stage 2: model-based collaboration
- Stage 3: network-based integration

The BIM maturity stages provided a systematic framework for the classification of BIM implementation. In order to provide a clear insight, the BIM maturity stages are described briefly below.

The Pre-BIM Status: Pre-BIM status refers to traditional construction practice which embraces significant barriers and inefficiencies, for example, much project information is stored on paper (as drawings and written documents). This is frequently unstructured and difficult to use. It is also easy to lose or damage. Thousands of documents are shared during a typical project, causing significant human errors in version control and use. A poor information management process leads to an incomplete understanding of the planned construction, functional inefficiencies, inaccurate initial work or clashes between components. Furthermore, the lessons learned have a short life span and, if recorded in the paperwork, are often difficult to retrieve. It is, therefore, difficult to compile and disseminate useful knowledge and best practice to other projects.

BIM Stage 1: Stage 1 refers to the migration from 2D to 3D and object-based modelling and documentation. The BIM model is made of real architectural elements that are represented correctly in all views. The BIM model is still single-disciplinary and the deliverables are mostly CAD-like documents; existing contractual relationships and liability issues persist.

Join the best at the Maastricht University School of Business and Economics!

Top master's programmes

- 33rd place Financial Times worldwide ranking: MSc International Business
- 1st place: MSc International Business
- 1st place: MSc Financial Economics
- 2nd place: MSc Management of Learning
- 2nd place: MSc Economics
- 2nd place: MSc Econometrics and Operations Research
- 2nd place: MSc Global Supply Chain Management and Change

Sources: Keuzegids Master ranking 2013; Elsevier 'Beste Studies' ranking 2012; Financial Times Global Masters in Management ranking 2012

Maastricht University is the best specialist university in the Netherlands (Elsevier)

Visit us and find out why we are the best!
Master's Open Day: 22 February 2014

www.mastersopenday.nl



BIM Stage 2: Stage 2 progresses from modelling to collaboration and interoperability. Designing and managing a building is a highly complex process that requires smooth communication and collaboration amongst all members of the project team. Stage 2 maturity requires integrated data communication and data sharing between the stakeholders to support this collaborative approach.

BIM Stage 3: This stage is the transition from collaboration to integration and it reflects the real underlying BIM philosophy. At this stage, project lifecycle phases dissolve substantially and players interact in real time to generate real benefits from increasingly virtual workflows. BIM Stage 3 models become interdisciplinary nD models (Lee et al., 2005) allowing complex analyses at the early stages of virtual design and construction. At this stage, model deliverables extend beyond semantic object properties to include business intelligence, lean construction principles, green policies and whole lifecycle costing.

After the above discussion, it will be easier to look into and understand the government's description of the BIM levels since there is significant compliance between the stages above and the government's BIM levels.

In response to the UK government's call for level 2 BIM by 2016, many standards, forms of guidance and tools have been/are being developed to help achieve this target. Figure 1.6 shows the BIM maturity levels proposed by the UK government. It shows the level 2 requirement that the UK government has set and its associated standards and guidance documents that aid the support of its delivery. Level 3 is the fully integrated approach towards full lifecycle management.

The government's BIM Maturity Levels similarly incorporate 4 levels: Level 0, Level 1, Level 2 and Level 3. The purpose of these levels is to classify technical and collaborative working to provide a clear and concise understanding of BIM for the supply chain and the client. In addition, they address a number of standards and technical specifications with an aim of establishing a common language and a guide/rule for consistent use and adoption. While some of those standards have been published, some others are under development. Although it is not necessary for many of the stakeholders to know all these standards, it can be helpful for those coordinating the BIM operations if they are aware of these standards and are sufficiently knowledgeable about when each standard should be applied for smooth interoperability.

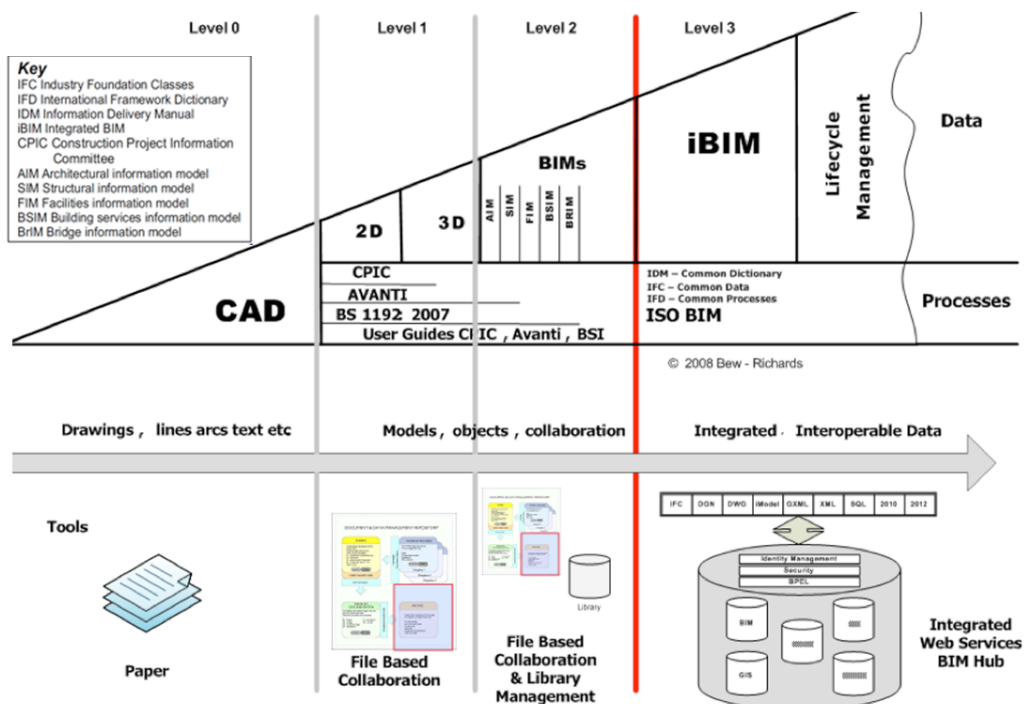

Figure 1.6: BIM Levels (BIM Task Group, 2012)

The BIM levels that are presented in figure 1.6 are described below.

Level 0 is the era of Computer Aided Design (CAD) which only requires working with flat CAD data with no 3D and it reflects the traditional working style of the industry with drawings often produced in the form of DWG and DGN or DXF.

Level 1 incorporates working with 2D and 3D data but this is only for visualisation purposes. These data are managed according to BS1192 with a file based collaboration through a common data environment. These models are not creating useful information that can be shared with other members of the team, for example, commercial data is managed by standalone finance and cost management packages with no integration.

Level 2 is about individual discipline-based BIM models used for collaboration. However, the full potential of a BIM model may not have been realised at Level 2. Level 2 BIM is called pBIM (proprietary BIM) because collaboration is enabled on the basis of proprietary interfaces or bespoke middleware. The Level 2 approach can utilise 4D construction planning simulation and 5D cost estimations, etc. The information from such as modelling and collaboration, via these models, will be in COBie (Construction Operations Building Information Exchange) format for UK government projects over £5 million.

Level 3 is described as iBIM (Integrated BIM) and BIM data is shared in an integrated computer environment (which is a reminder of the concept of CIC) across the supply chain including operation and maintenance. This level of BIM implementation considers a fully integrated streamlined building lifecycle process enabled via IFC/IFD (Industry Foundation Classes/International Framework Dictionary) and collaboration via model server technologies. In other words, Level 3 BIM is, potentially, employing concurrent engineering processes.

Figure 1.7 below shows a clearer understanding of the characteristics of the BIM Levels and it actually reflects strong conformance with the BIM maturity stages in figure 1.4.

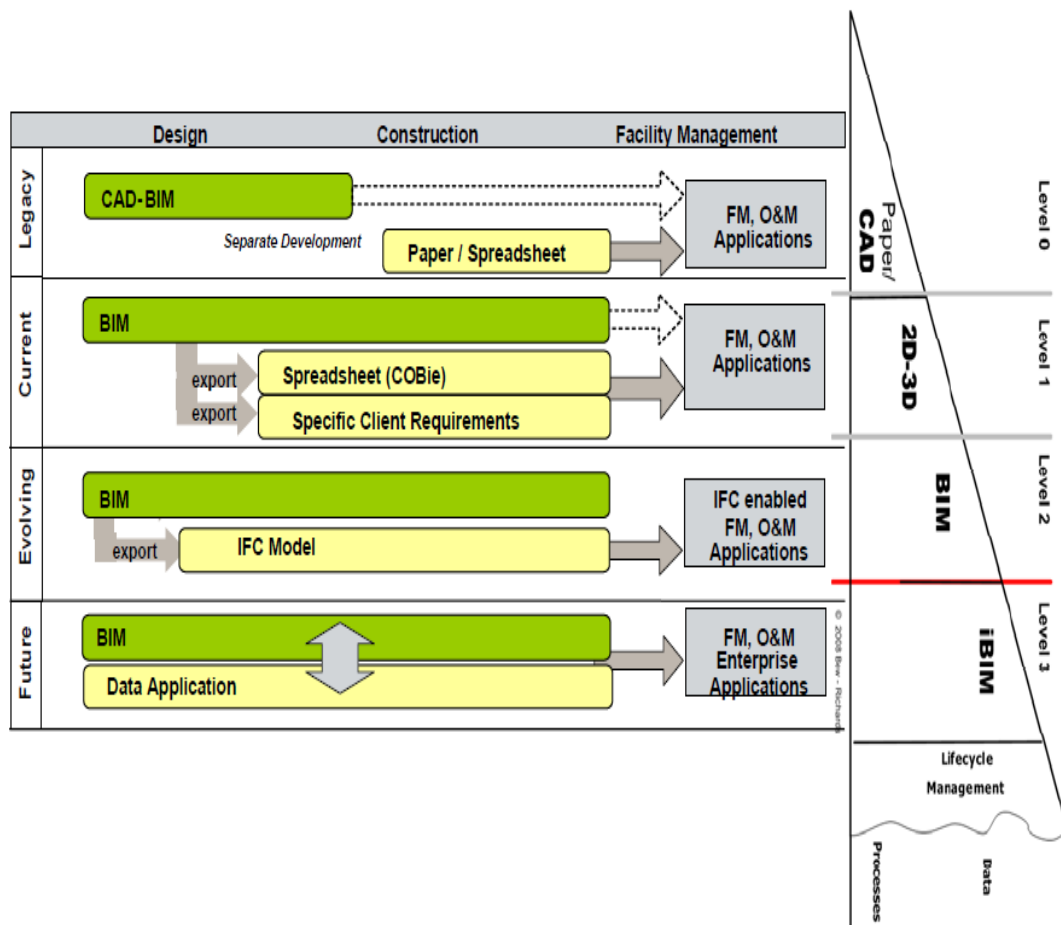

Figure 1.7: BIM Levels (BIM Task Group, 2012)

1.6 Conclusion

BIM is not a new concept any more but it has just started to draw attention in the construction industry. Some governments including UK are introducing legislations to make BIM use a mandatory requirement on public projects and some private clients are also paying attention to it. Many consultant and contractors have already started to utilise BIM tools and processes at company level by avoiding any direct contractual obligations to their client because they see the potential for cost and programme savings.

The UK Government has already adopted a preliminary vision of BIM as an incremental step change in the industry while there are still practical challenges in terms of technology, contract and procurement structures. However, BIM Level 2 is only the start in the transition through the continuous improvement relating to the effectiveness and efficiency of the UK Construction Industry.

1.7 References

Alshawi M., Putra C.W. and Faraj I., (1996), A structured concept for objects life cycle in integrated environments, *Microcomputers in Civil Engineering*, Blackwell, 12, 339–351.

Aouad, G. and Arayici, Y., (2010), *Requirements engineering for computer integrated environments in construction*, Wiley-Blackwell, Oxford, United Kingdom.

Aouad, G., Sun, M., Bakis, N. and Swan, W., (2001), *GALLICON Final Report*, January 2001.

Aouad, G., Cooper, R., Fu, C., Lee, A., Ponting, A., Tah, J., and Wu, S., (2005), *nD Modelling – a driver or enabler for construction improvement*, RICS Research paper series, Volume 5, number 6.

Aouad G., Marir F, Child T, Brandon P, and Kawooya A., (1997), *A construction integrated databases-linking design, planning and estimating*, International Conference on Rehabilitation and Development of Civil Engineering Infrastructure Systems, American University of Beirut, Lebanon.



> Apply now

REDEFINE YOUR FUTURE
**AXA GLOBAL GRADUATE
PROGRAM 2015**

redefining / standards 

agence.cdg. © Photomistop



Arayici, Y. and Aouad, G., (2004), DIVERCITY: distributed virtual workspace for enhancing communication and collaboration within the construction industry, European Conference on Product and Process Modelling in the Building and The Construction Industry (ECPPM), Istanbul, Turkey, 415–422.

Bazjanac, V., (2004), Virtual building environments (VBE) – applying information modelling to buildings, Proceeding of European Conference on Product and Process Modelling in the Building and the construction industry (ECPPM), Istanbul, Turkey, 41–48.

BIM Task Group (2012), Building Information Modelling; Industrial Strategy: Government and Industry Partnership, www.bis.gov.uk

Faraj, I., and Alshawi, M., (1999), A modularized integrated computer environment for the construction industry, SPACE, University of Salford, UK.

Greening R. and Edwards M., (1995), ATLAS Implementation Scenario, Proceedings ECPPM'94: Product and Process Modelling in the Building Industry, Scherer (ed.), 467–472.

Hannus, M., (1998), Islands of automation in construction, <http://cic.vtt.fi/hannus/islands/index.html>

Isikdag, U., Underwood, J., Kuruoglu, M., Goulding, J., Acikalin, U. (2009) Construction informatics in Turkey: strategic role of ICT and future research directions, Journal of Information Technology in.

Construction (ITcon), Vol. 14, Special Issue Next Generation Construction IT: Technology Foresight, Future Studies, Roadmapping, and Scenario Planning, pg. 412–428, <http://www.itcon.org/2009/27>

Khosrowshahi, F. and Arayici, Y., (2012), Roadmap for implementation of BIM in the UK construction industry, Engineering, Construction and Architectural Management, **19** (6), pp 610–635.

Laiserin, J., (2003), AEC Interoperability and the BLIS Project, CADALYST Magazine.

Lee, A., Wu, S., Aouad, G., Cooper, R. and Tah, J. (2005), nD Modelling Roadmap: A Vision for nD Enabled Construction, University of Salford Salford.

Maunula, A., (2008), The Implementation of Building Information Modeling (BIM), A process Perspective, Helsinki University of Technology SimLab Publications, Report 23.

Molina, J.M. and Martinez, M., (2004), XML Based data model for the Spanish AEC sector, Proceeding of European Conference on Product and Process Modelling in the Building and The Construction Industry (ECPPM), Istanbul, 149–154.

Nour, M., (2007), Manipulating IFC sub-models in Collaborative Teamwork Environments, ITC Digital Library, <http://itc.scix.net/>

Steinman, R., (2004), MOBIKO – Mobile cooperation in the construction industry based on wireless technology, Proceeding of European Conference on Product and Process Modelling in the Building and the Construction Industry (ECPPM), Istanbul, 521–526.

Succar, B., (2009), Building information modelling framework: a research and delivery foundation for industry stakeholders, Automation in Construction, Vol. 18 No. 3, pp. 357–75.

Szigeti, F. and Davis G., (2003), Portfolio and asset management: performance requirements, the IAI-NA PAMPer+ED project, International Centre for Facilities.



**Empowering People.
Improving Business.**

BI Norwegian Business School is one of Europe's largest business schools welcoming more than 20,000 students. Our programmes provide a stimulating and multi-cultural learning environment with an international outlook ultimately providing students with professional skills to meet the increasing needs of businesses.

BI offers four different two-year, full-time Master of Science (MSc) programmes that are taught entirely in English and have been designed to provide professional skills to meet the increasing need of businesses. The MSc programmes provide a stimulating and multi-cultural learning environment to give you the best platform to launch into your career.

- MSc in Business
- MSc in Financial Economics
- MSc in Strategic Marketing Management
- MSc in Leadership and Organisational Psychology

BI NORWEGIAN BUSINESS SCHOOL

EFMD
EQUIS
ACCREDITED

www.bi.edu/master



2 BIM Tools and Technologies

2.1 Introduction

Nowadays, every development in the field of technology is accomplished by progress made in computer science which provides more information in order to accomplish goals easily. In the construction sector, design tools have been developed from 2D CAD through 3D modelling to object oriented modelling with BIM which has brought in a transformation within the AEC industry based on advanced IT technologies with the aim of providing benefits throughout the building lifecycle process. This technological advancement has also introduced many different BIM tools and technologies specializing in various AEC tasks and activities from design to construction and FM. However, there is a general lack of understanding and knowledge of the main functionalities and key competences of these technologies, even though it is strategically important to utilize these tools for the right tasks and activities in order to reap the full benefit from them.

Several studies have revealed that there is still an inefficient use of BIM tools and that the construction industry is, presently, still using CAD tools. Thus, it is important to map BIM tools and technologies with relevant tasks and activities in the lifecycle process. While this chapter initially introduces, and elaborates upon, these tools, the next chapter will map out these technologies within the building lifecycle process with an aim of providing a guide for the efficient use of BIM by professionals with a clear description of how it can accomplish their tasks at the various stages of design, construction and operation. This would also provide beneficial guidance when selecting BIM tools and which is the appropriate one in the BIM implementation scenarios undertaken by the companies.

2.2 CAD technologies

Many industries such as construction, manufacturing, the automotive industry, etc. have used CAD technology for many years and it supports automation in drafting effectively (Forbes & Ahmed, 2011). In fact, to obtain the highest levels of efficiency, it requires high levels of effort in programming and customization according to the disciplines and users who are responsible for entering and manipulating data (Autodesk, 2003). An example of a CAD technology is AutoCAD software and, with enough programming effort and discipline-based customization, it is possible to reap some benefits of BIM (Autodesk, 2003) using this software such as scheduling, cost estimating and structural design (Forbes & Ahmed, 2011).

2.2.1 Object Based CAD Technologies

Object based CAD technologies concentrate on simulating building components in a CAD platform and accommodate building designs in 3D geometry (Forbes & Ahmed, 2011). It helps extract information about quantities and 2D documentation from the building components. Furthermore, it can also support coordinating the different representations of the documentation for a building and can be extended into BIM because it contains rich data about the building in an object based structure. For example, Autodesk has many products that build on Object CAD technology such as Autodesk Building System and Autodesk Architectural Desktop (ADT) which can be used to achieve BIM benefits with less effort than that which is required for using AutoCAD (Forbes & Ahmed, 2011).

2.3 Parametric modelling technologies

Parametric modelling offers the most advanced level of information modelling for a building with a lower amount of effort than that required for CAD and Object CAD and it is the more efficient than Object CAD and CAD technologies, as illustrated in figure 2.1 (Forbes & Ahmed, 2011).

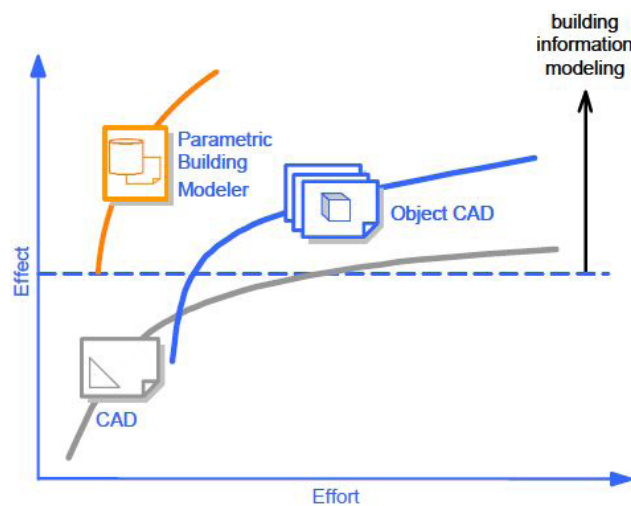

Figure 2.1: The effect/effort ratio of BIM technologies (Autodesk, 2003)

Object based parametric modelling uses many of the characteristics which are called “parameters” in order to demonstrate the properties of each object and the associated rules that clarify the relationships between them, as illustrated in figure 2.2. It contains some of non-geometric properties and features such as price, spatial relationship, manufacture, geographic information, vendor, materials, code requirements and any other related parameter associated with how the object is actually being used (Jiang, 2011). However, 2D CAD and 3D modelling systems describe just the building form and they are used to present and visualize the designs descriptively (Penttila, 2009).

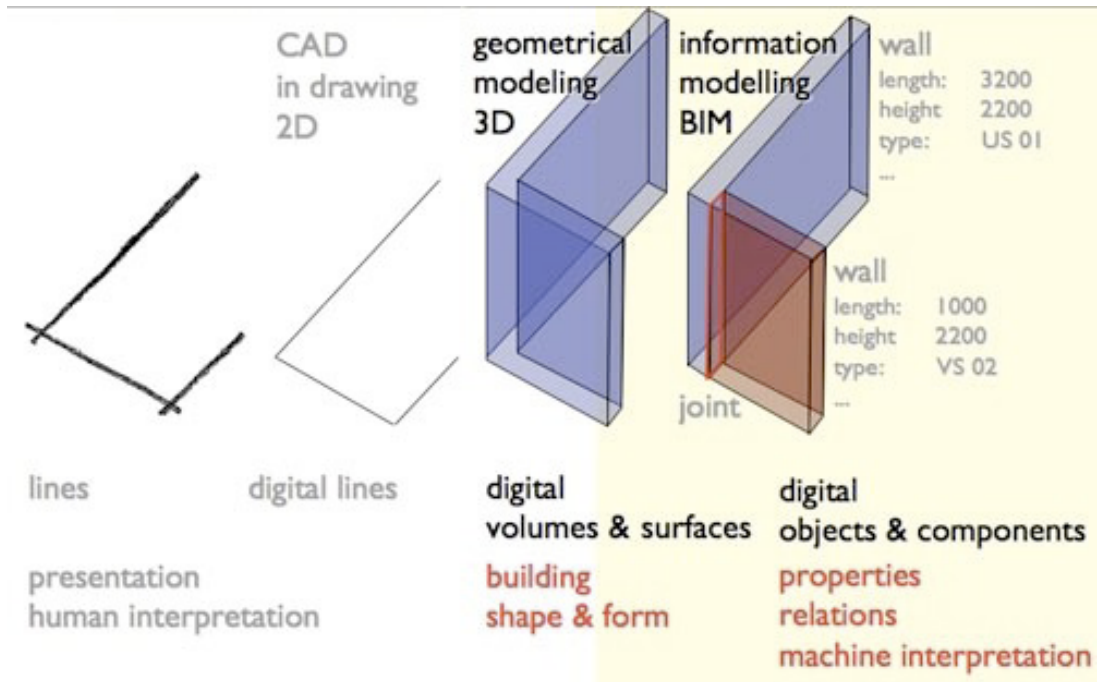

Figure 2.2: The evolution of the CAD system (Penttila, 2009)

Need help with your dissertation?

Get in-depth feedback & advice from experts in your topic area. Find out what you can do to improve the quality of your dissertation!

[Get Help Now](#)



Go to www.helpmyassignment.co.uk for more info



Similarly, Azhar et al. (2012) demonstrated that conventional 3D CAD describes a building by utilising independent 3D views such as elevations, plans and sections and any addition or modification to one of these views requires that all other views have to be updated and checked. In addition, the data in 3D drawings are only graphical geometric primitives such as circle, arc and line, whereas, in a BIM model, the objects are defined in terms of building systems and elements such as column, beam, wall and space, and any change to an object within the model will be reflected automatically in the rest of the views of the project. For instance, if a user deletes a door from a section, the software automatically removes the door from the elevations, plans and schedules (Krygiel & Nies, 2008). Thus, the resulting model includes a “data rich”, “object oriented”, “intelligent and parametric digital representation of the facility” which can be used to extract and analyze information in order to make decisions as well as enhancing the process of delivering the facility (Gardezi et al., 2013).

An example of parametric building technology is Autodesk Revit software which is designed specifically for BIM (Autodesk, 2003). It has a central project database which includes representation of all building components (Forbes & Ahmed, 2011). The following kinds of models do not utilize BIM design technology (Eastman et al. 2011):

- Models that allow changes to dimensions in one view that are not automatically reflected in other views.
- Models that are composed of multiple 2D CAD reference files that must be combined to define the building.
- A model with no support of behaviour which can define objects but cannot adjust their proportions or positioning due to the fact there is no parametric intelligence.
- Models that contain 3D data only and no (or few) object attributes which can only be used for graphic visualizations and in which there is no intelligence object such as SketchUp application.

2.4 BIM Tools

Building Information Modelling is not one single process enabled by single software but incorporates many cross-cutting processes that require many software solutions, each of which has different and specific functional abilities to perform specific work related tasks within the cross-cutting cross organisational business processes (Thomassen, 2011). Accordingly, BIM models are produced by a number of BIM software packages such as Bentley BIM tools, Graphisoft’s ArchiCAD and Autodesk’s Revit (Brewer et al., 2012).

Eastman et al. (2011) indicated that software tools are used at different stages in a project to produce a specific outcome such as energy analysis, drawing production, visualization, clash and error detection, scheduling, rendering, and so on. They also emphasized that there is no one application that can be ideal for all kinds of projects and that each organization will have many platforms to provide support and to move between for specific projects, for example, some platforms provide collaboration with a particular consultant or fabricator while others may support communication between various applications. Similarly, Latiffi et al. (2013) stated that each BIM tool has its own functions which can be utilized to manage various activities within construction projects.

The use of these tools can increase quality and result in savings in cost and time over the lifecycle of a building (National Research Council of Canada, 2011). Also, BIM tools can support the lifecycle processes of a project by allowing for referencing to a model and connected information (Lucas et al., 2009).

Today, there is a large amount of BIM software available in the AEC industry which can be used by different stakeholders in construction projects. A survey conducted by McGraw-Hill Construction (2008) showed that Autodesk BIM tools are the most widely used in the AEC industry (67% Revit and 71% Navisworks). It is then followed by Bentley tools with 36% of the market while ArchiCAD and Tekla are utilized by 34% and 10% respectively as shown in figure 2.3. Other software tools such as Vectorworks and Digital project are only used by a small proportion of respondents. Research published in the literature such as Azhar et al. (2008); Arayici et al. (2009); Lucas et al. (2009), and Liu et al. (2011) also shows that Revit, ArchiCAD and Bentley are the most popular software amongst users in the construction industry.



Brain power

By 2020, wind could provide one-tenth of our planet's electricity needs. Already today, SKF's innovative know-how is crucial to running a large proportion of the world's wind turbines.

Up to 25 % of the generating costs relate to maintenance. These can be reduced dramatically thanks to our systems for on-line condition monitoring and automatic lubrication. We help make it more economical to create cleaner, cheaper energy out of thin air.

By sharing our experience, expertise, and creativity, industries can boost performance beyond expectations. Therefore we need the best employees who can meet this challenge!

The Power of Knowledge Engineering

Plug into The Power of Knowledge Engineering.
Visit us at www.skf.com/knowledge

SKF



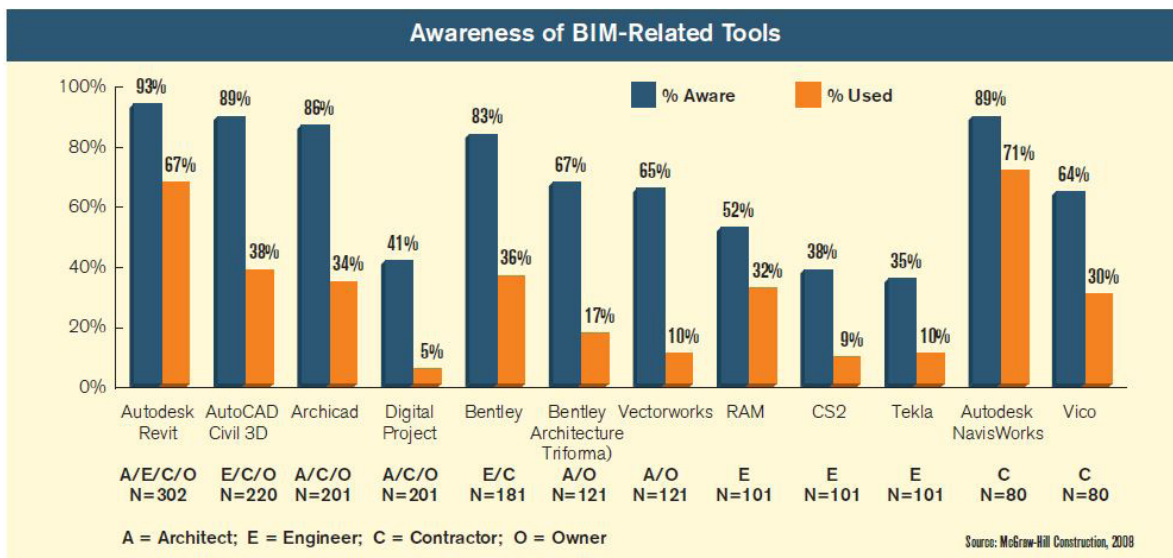

Figure 2.3: Awareness of BIM tools (McGraw-Hill Construction, 2008)

2.4.1 Classification of BIM Tools

Different kinds of BIM tools are available in the construction industry today which can be used to serve various functions. As a matter of fact, no BIM tool can do everything (McGraw-Hill Construction, 2008). These tools are generally classified into three types: Authoring tools, Analysis tools and Validation tools (Siddiqui, 2010).

2.4.1.1 Authoring Tools

Software such as ArchiCAD and Revit are considered as authoring tools because the primary function of these tools is to build a 3D model which will be later used for different purposes (Siddiqui, 2010). Table 2.1 shows BIM authoring tools and their primary functions. Some of these tools in the list also have the ability to undertake cost estimation and scheduling (Hergunsel, 2011).

2.4.1.2 Analysis Tools

After the development of a 3D model by an authoring tool, the model built by the authoring tool can be transferred to analysis tools such as Green Building Studio and Ecotect for energy analysis, thermal comfort and daylighting (Siddiqui, 2010).

According to McGraw-Hill Construction (2008), BIM analysis tools have the ability to extract information from BIM models and perform valuable analysis. Quantity Take-off is the leading example of this functionality, as shown in figure 2.4. The main strength of these tools is the ability to run “what if” scenarios which leads to optimal solutions (Foundation of the Wall and Ceiling Industry, 2009). Consequently, project value will be improved significantly, especially in energy efficiency which is crucial for the accreditation of environmental labels (Gaudin, 2013).

Product Name	Manufacturer	Primary Function
Revit Architecture	Autodesk	3D Architectural modelling and parametric design
AutoCAD Architecture	Autodesk	3D Architectural modelling and parametric design
Revit Structure	Autodesk	3D Structural modelling and parametric design
Revit MEP	Autodesk	3D Detailed MEP modelling
AutoCAD MEP	Autodesk	3D MEP modelling
AutoCAD Civil 3D	Autodesk	Site Development
Cadpipe HVAC	AEC Design Group	3D HVAC modelling
Cadpipe Commercial Pipe	AEC Design Group	3D pipe modelling
DProfiler	Beck Technology	3D conceptual modelling with real time cost estimating
Bentley BIM Suite (Microstation, Bentley Architecture, Structural, Mechanical, Electrical, Generative Design)	Bentley System	3D Architectural, structural, mechanical, electrical and generative component modelling and design
Fastrak	CSC(UK)	3D Structural modelling
SDS/2	Design Data	3D Detailed MEP modelling
Digital project	Gehry Technologies	CATIA based BIM system for Architectural, Design, Engineering and Construction Modelling
Digital Project MEP Systems Routing	Gehry Technologies	MEP Design
ArchiCAD	Graphisoft	3D Architectural Modelling
MEP Modeller	Graphisoft	3D MEP Modelling
HydraCAD	Hydratec	3D Fire Sprinkler Design and Modelling
AutoSPRINK VR	MEP CAD	3D Fire Sprinkler Design and Modelling
FireCAD	Mc4 Software	Fire piping Network Design and Modelling
CAD Duct	Micro Application	3D Detailed MEP Modelling
Vectorworks Designer	Nemetschek	3D Architectural Modelling
Duct Designer 3D, Pipe designer 3D	QuickPen International	3D Detailed MEP Modelling
RISA	RISA Technologies	Full Suite of 2D and 3D Structural Design Applications
Tekla Structures	Tekla	3D Detailed Structural Modelling
Affinity	Trelligence	3D Model Applications for early concept design
Vico Office	Vico Software	5D Modelling for generating cost and schedule data
PowerCivil	Bentley Systems	Site Development
Site Design, Site Planning	Eagle Point	Site Development
Solibri	Solibri Technologies	Design review, clash detection, code checking

Table 2.1: List of BIM tools and technologies based on their specific application areas

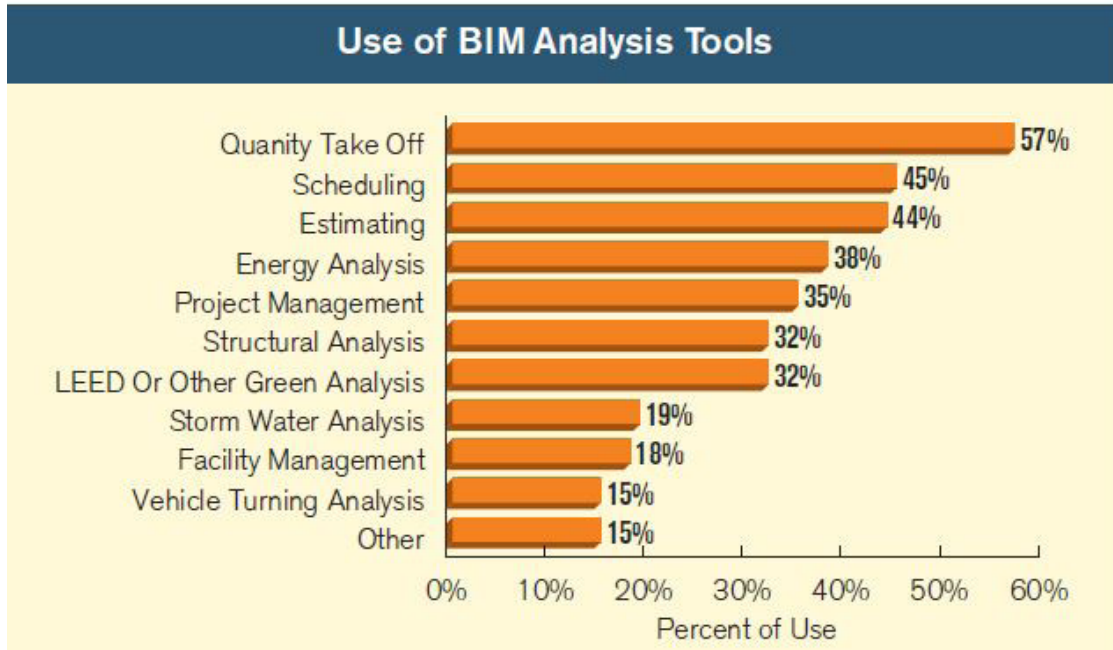

Figure 2.4: Use of BIM analysis tools (McGraw-Hill Construction, 2008)

“I studied English for 16 years but...
...I finally learned to speak it in just six lessons”
Jane, Chinese architect

ENGLISH OUT THERE

Click to hear me talking before and after my unique course download



2.4.1.3 Validation Tools

Software programmes such as Solibri model checker and Navisworks are important parts of Building Information Modelling because they offer accuracy and authenticity to the 3D model platform. These tools can be used to check different issues in different phases of a project such as clash detection, code compliance, construction sequencing (Siddiqui, 2010).

2.5 Review Of Major BIM Tools In The Aec Industry

As mentioned previously, there are a number of software packages available to different disciplines of the construction industry that can facilitate BIM. The major software programmes are given below.

2.5.1 Revit

Revit was introduced to the AEC industry in 2002 by the Autodesk Company and has been widely adopted by many architecture companies who are using Building Information Modelling (Jiang, 2011). It is a BIM authoring tool that provides design ability with drafting elements and parametric modelling (Hardin, 2009). It has the biggest market share and has the largest number of associated applications (Foundation of the Wall and Ceiling Industry, 2009). Furthermore, it has the ability to interface with other tools through IFC, DXF, DWF, DWG and gbXML files (Chen & Gehrig, 2011).

Revit also imports models from McNeel Rhinoceros, Google earth conceptual tools, AutoDesSys, SketchUp and other tools that export DXF files (Eastman et al., 2011). The Revit package consists of three software applications; Revit MEP, Revit Structure and Revit Architecture (Azhar et al., 2008). Mechanical engineers can use Revit MEP to create a model of piping, ducts and to acquire a better understanding of HVAC details. Furthermore, Revit MEP helps electrical engineers to model the placement of light fixtures and also to create wiring and circuits while Revit Structure can be used by structural engineers for analysis and performing structural design using basic components' modelling such as foundations and walls, whereas Revit Architecture is used for the architectural design of a building such as roof, doors, staircases and walls (Latiffi et al., 2013).

2.5.1.1 Revit's Strengths and Weaknesses

Revit menus are well organized in terms of workflow and its drawing production tools are excellent. In addition, it has a very large set of objects' libraries, especially its own Autodesk (SEEK) library for design objects and specification, which support a multiuser interface (Eastman et al., 2011).

On the other hand, Revit has limited support for complex curved surfaces and a few limitations on parametric rules. Added to these, it has problems in its memory system which makes access very slow for projects larger than 300MB (Eastman et al., 2011).

2.5.2 Bentley Systems

Bentley Systems has an integrated project suite that consists of multiple application modules (Forbes & Ahmed, 2011). The modules comprise Bentley Power Civil, Bentley Generative Components, Bentley Structural, Bentley Architecture, Bentley Facilities, Bentley Electrical systems and Bentley Mechanical Systems (Foundation of the Wall and Ceiling Industry, 2009).

Bentley describes this integrated approach as an evolutionary path that allows its Microstation users to migrate work practices that still have their origins based on using CAD tools (Underwood & Isikdag, 2010). Bentley products' interfaces includes: IFC, PDF, STEP, DXF, IGES, DWG, STL, DGN and CGM (Eastman et al., 2011). Actually, Bentley products can deal with almost all aspects of the construction industry (architecture, engineering, infrastructure and construction) such as transportation operations, plant operations, building design and analysis, bridge design and engineering, water and wastewater Network design and analysis, rail design and operations, facility Information Management and others (Jiang, 2011), (Eastman et al., 2011). Bentley demonstrates the "I" in stands for five new capabilities and enhancements: a high degree of *interoperability*, *incredible* project performance and speed, *intrinsic* geo-coordination capability, *interactive* dynamic views, and more *intuitive* conceptual modelling capabilities (Jiang, 2011).

2.5.2.1 Bentley Systems' Strengths and Weaknesses

Bentley provides multiplatform and server capabilities and it supports modelling with complex curved surfaces, including B-splines and Bezier (Eastman et al., 2011). In terms of drawing production, 2D detailing and annotation on a 3D model section are well organized (Eastman et al., 2011). On the other hand, it is hard to learn and navigate (Chen & Gerhrig, 2011; Eastman et al., 2011). Also, the file formats supported by Bentley systems are not as varied as Autodesk tools. Thus, there is a limitation in terms of interoperability (Jiang, 2011).

2.5.3 ArchiCAD

ArchiCAD is the oldest BIM design tool in the AEC industry and it is the only system that runs on an Apple Macintosh (Chen & Gerhrig, 2011). ArchiCAD was developed by Graphisoft in the early 1980s and it was designed based on a virtual building model (Forbes & Ahmed, 2011). In fact, ArchiCAD encompasses a wide range of predefined parametric objects including modelling capabilities for interiors, space planning capabilities, and site planning (Eastman et al., 2011). It has comprehensive object libraries for users such as wood, metals, plumbing, precast concrete, HVAC, thermal and moisture protection, masonry and so on. It has links to multiple tools through IFC, GDL and also has an Open Database Connectivity interface (Eastman et al., 2011). Furthermore, ArchiCAD contains a build-in analysis tool in order to conduct energy analyses on the BIM models. Furthermore, it provides the Virtual Building Explorer (3D navigation) which is supported with pre-saved walkthroughs, egress recognition, gravity, fly-mode and layer control (Jiang, 2011).

2.5.3.1 ArchiCAD's Strengths and Weaknesses

ArchiCAD has a wide spectrum of applicability for various applications such as facility management, building systems and design. Therefore, it can be utilized in all stages of a project except fabrication detailing. Additionally, it has a large object library (Eastman et al., 2011). On the other hand, it has several limitations in parametric modelling capabilities (Eastman et al., 2011).

2.5.4 FMDesktop

FMDesktop was designed by Autodesk in 2006 to address the four main functions of facility management including maintenance management, emergency management, project management, and space and asset management (Khemlani, 2007). Autodesk FMDesktop contains four major components which are available separately but which are related applications (Autodesk, 2008):

- Facility manager: represents the cornerstone of the FMDesktop software and can be used to implement maintenance procedures and schedules, to manage repairs or renovation projects, and to track and maintain assets and spaces. Additionally, it has the ability to manage data and all facility drawings in one database environment enabling facility managers to share data and facility drawings, to print, zoom, pan, and query with no need for any other tool.
- Facility web: allows the facility data and drawings to be published online, offering read-only access to reports, drawings, and data to anyone who needs them.
- Facility request: also a web based application that enables users to submit work requests to facility managers or maintenance managers for a specific location.
- Facility link: used to link objects in the facility drawings to the records in the FMDesktop database through an intuitive interface.

Autodesk FMDesktop connects graphical elements contained in design drawings and BIM models to backend database engines including Microsoft Access, Microsoft SQL or Oracle (Autodesk, 2008). Additionally, Autodesk FMDesktop is compatible with other platforms such as Revit, Autodesk Architectural Desktop, AutoCAD and Microsoft Excel.

DWF technology is used by Autodesk FMDesktop to import data from other tools and automatically interprets the space and room data (Khemlani, 2007). In fact, FMDesktop can merge data from different sources and can utilise the data that comes from designers and builders who have worked on various properties or renovated spaces using diverse authoring tools (Autodesk, 2008).

The facility manager can then go ahead and create additional information about each room or floor plans such as room numbers, types, occupant's information, equipment, capacity, and so on (Khemlani, 2007). In addition, documents such as manuals and warranties can be connected to the elements in the building model and then uploaded to the documents' zone of Autodesk FMDesktop and attached to the imported assets (Autodesk, 2008).

2.5.4.1 FMDesktop's Strengths and Weaknesses

FMDesktop provides an intuitive interface and easy to use features for users as well as enabling the swift storing and locating of up-to-date information about building operations including spare parts, service contracts, warranties, etc. (Beyond the Paper, 2006). It has the ability to retrieve some information about equipment, furniture, windows, doors, walls and spaces but not on spatial and topological relationships (Akcamete, Akinici & Garrett, 2010).

2.5.5 Tekla Structures

Tekla Structures was introduced by the Tekla Company in the mid-1990s and was initially known as Xsteel utilised widely for steel detailing applications (Eastman et al., 2011). The main function of Tekla Structures concerns structural design and it offers the opportunity to create a digital model that contains the structure along with both an analytical model and physical model; this structural model can then be utilized for various types of structural analysis (Jiang, 2011). Tekla Structures can be used by manufacturers, fabricators, detailers and contractors for different purposes such as generating detailed information for rebar, detailing, precast and steel (Chen & Gehrig, 2011). It supports a wide range of exchange formats such as DGN, DXF, IFC, DWG, SDNF and others. Tekla Structures also has links with different applications (Eastman et al., 2011).



What do you want to do?

No matter what you want out of your future career, an employer with a broad range of operations in a load of countries will always be the ticket. Working within the Volvo Group means more than 100,000 friends and colleagues in more than 185 countries all over the world. We offer graduates great career opportunities – check out the Career section at our web site www.volvogroup.com. We look forward to getting to know you!

VOLVO
AB Volvo (publ)
www.volvogroup.com

VOLVO TRUCKS | RENAULT TRUCKS | MACK TRUCKS | VOLVO BUSES | VOLVO CONSTRUCTION EQUIPMENT | VOLVO PENTA | VOLVO AERO | VOLVO IT
VOLVO FINANCIAL SERVICES | VOLVO 3P | VOLVO POWERTRAIN | VOLVO PARTS | VOLVO TECHNOLOGY | VOLVO LOGISTICS | BUSINESS AREA ASIA

Download free eBooks at bookboon.com



Click on the ad to read more

2.5.5.1 Tekla Structures' strengths and Weaknesses

Tekla Structures has the ability to model structures that contain a considerable amount of detailing and structural materials. It is also capable of supporting large models including concurrent operations on the same project and with multiple users (Eastman et al., 2011). On the other hand, it is quite complex in executing its functions which take time to learn and fully utilize, and also it is relatively expensive (Eastman et al., 2011). It has interfaces with many different applications as shown in table 2.2; this also indicates that Tekla is advancing its interoperability capabilities.

Application	Company	Capabilities
AxIsVM	Inter-VCAD Kft	CNC fabrication
CYPECAD	Cype	Structural design & analysis of reinforced concrete
Diamonds	Buildsoft	Structural design and analysis
Fastrak	CSC	Structural design and analysis
FEM Design	StruSoft	Structural design and analysis
MidasGen	MIDAS	Structural design and analysis
ModeSt	Technisoft	Structural design and analysis
NISA	Cranes Software International Ltd.	Structural analysis
PowerFrame	Buildsoft	Structural analysis
RFEM	Dlubal	Structural analysis
Robot Millenium	Autodesk	Structural analysis
RSTAB	Dlubal	Structural design and analysis
SAP2000	Computers & Structures, Inc.	Structural analysis
SCIA	Nemetschek	Structural analysis
S-Frame	CSC/Softek	Structural analysis
STAAD	Bentley	Structural design and analysis
STRUDS	SoftTech	Structural design and analysis
Trimble LM80	Trimble	Jobsite layout, survey equipment
BuildSite	BuildSite	Product and technical information for manufacturing and distributors
Meridian Prolog Converge	Meridian	Project Management

Table 2.2: BIM Applications with which Tekla has an interface

2.5.6 Navisworks

Autodesk Navisworks is considered as a powerful tool for project managers for combining multiple 3D into a single workspace in order to identify clashes, optimize scheduling, simulate, and establish collaboration between design team and contractors, and this collaboration supports the project team in gaining an insight into potential problems (Hardin, 2009; Latiffi et al., 2013).

Navisworks can import modelling files such as gbXML, IFC, DXF, DWG and others from a wide range of BIM software packages (Chen & Gehrig, 2011). It can be used for different purposes such as performing clash detection, real time navigation, generating photorealistic visualization and running construction sequencing simulation (4D) (Chen & Gehrig, 2011). However, it must be noted that Navisworks is not a modelling tool but is rather analysis software (Hardin, 2009). In fact, 3D files and BIM models can be linked into a Navisworks format (NWD) which is more commonly used than the other formats (NWF – Navisworks Web Format). Both files are viewed with Naviswork’s 3D viewer, namely Navisworks Freedom. Navisworks comes with a special characteristic called Timeliner to simulate construction schedules. Timeliner can connect Primavera project planner, Mictosoft Project with different BIM (e.g. Revit), Laser Scan formats and CAD (Hergunsel, 2011).



The advertisement for Gaiteye features a runner in a red shirt and black leggings running on a dirt path. The background is a warm, orange-toned sunset or sunrise. The Gaiteye logo, a yellow square with a white leaf-like shape, is positioned to the left of the brand name 'gaiteye' in a white, lowercase, sans-serif font. Below the logo is the tagline 'Challenge the way we run' in a smaller, italicized font. The main text 'EXPERIENCE THE POWER OF FULL ENGAGEMENT...' is in a bold, white, uppercase font. Below this is a horizontal line of yellow dots. Further down, the text 'RUN FASTER. RUN LONGER.. RUN EASIER...' is in a bold, white, uppercase font. To the right of the runner, there are white technical diagrams consisting of circles and lines, resembling a gait analysis or motion capture diagram. A yellow button with the text 'READ MORE & PRE-ORDER TODAY' and 'WWW.GAITEYE.COM' is located at the bottom right, with a white hand cursor icon pointing to it.



Finally, in a schedule animation, different activities can be shown such as crane erection, concrete foundation pour, excavation, site demolition, earthwork excavation, forming, truck loading, piers, pile driving, reinforcement and rebar; hence any activity that happens during the construction phase can be modelled by these 3D model components (Hardin, 2009).

2.5.6.1 Navisworks' Strengths and Weaknesses

The great advantage of using Navisworks is its ability to combine multiple files from many various file types (Hardin, 2009). However, the weakness that it has is that any identified clashes cannot be fixed immediately because the integrated model is not directly associated with the original model (Eastman et al., 2011).

2.5.7 Ecotect

Autodesk Ecotect is a complete building design and environmental analysis tool that covers the full range of simulation and analysis functions required to truly understand how a building design will operate and perform (Azhar et al., 2009). The major functionality of Ecotect includes shading and lighting analysis, thermal analysis, energy analysis and acoustic analysis (Azhar & Brown, 2009). The shading and lighting analysis tools offer different features such as lighting design, daylighting assessment, shading design, right to light analysis and solar analysis, while the thermal and energy analysis features take into consideration many aspects such as airflow and ventilation, cooling and heating loads, and resource management (Azhar & Brown, 2009).

Ecotect can be exported directly to other analysis tools such as Radiance and EnergyPlus. It can be exported to VRML, DXF and POV-Ray for more rendering (Marsh, 2003). Ecotect relies on the gbXML format to retrieve data from other BIM tools such as Bentley Architecture, ArchiCAD and Revit Architecture, as shown in figure 2.5 which shows interoperability between BIM authoring applications and performance analysis tools via gbXML and the primary functions of those analysis tools (Moakher & Pimplikar, 2012).

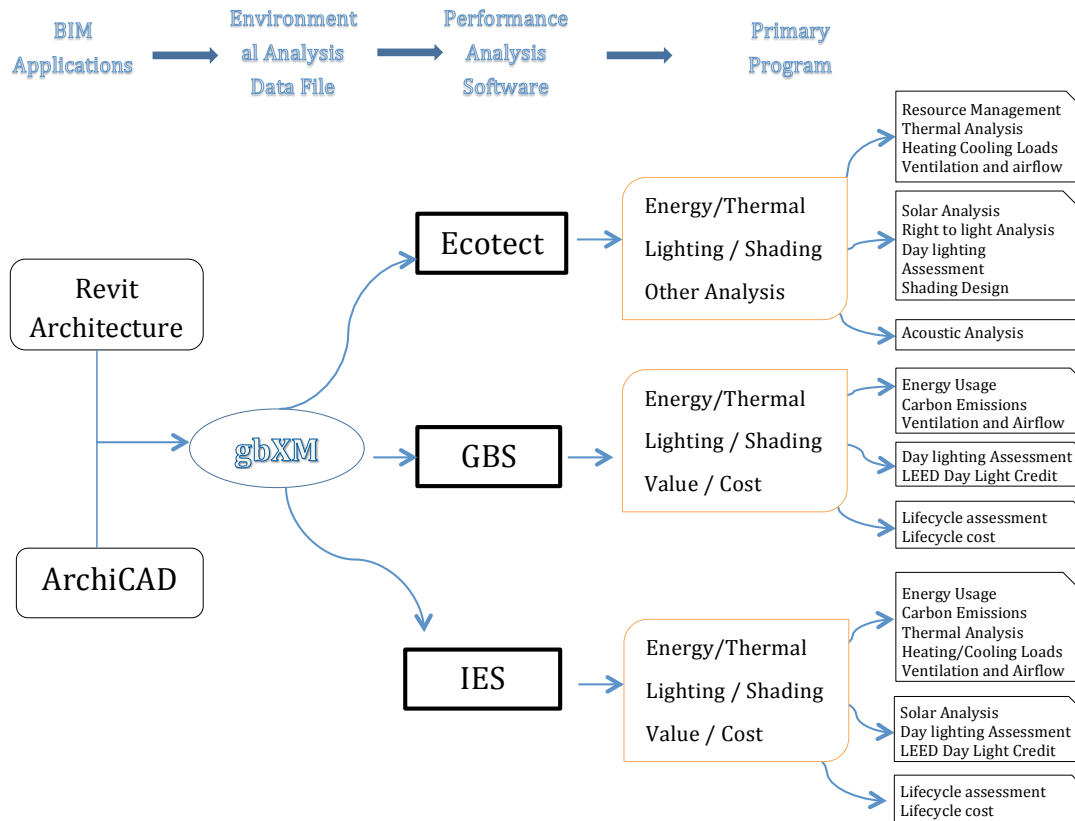

Figure 2.5: The interoperability links between BIM authoring tools and analysis tools alongside their key features

2.5.7.1 Ecotect Strengths and Weaknesses

The most significant feature of Ecotect is its visual and interactive display utilised to perform analysis (Moakher & Pimplikar, 2012). One of the drawbacks of other building analysis tools is the inability of the user to interpret the results of any analysis while Ecotect offers actionable feedback to the user as reports and visual display (Moakher & Pimplikar, 2012). On the other hand, some types of analysis in Ecotect cause instability within the programme such as unclear analysis steps (Azhar & Brown, 2009).

2.6 BIM Library

Building Information Modelling contains many objects’ based parametric models and these objects represent the physical elements of a building that belong to a product family such as doors, walls, windows, columns, etc. (Underwood & Isikdag, 2010). All BIM objects have properties and geometries and some information is located in the geometrical part of a BIM object while other information is more suited to the properties’ portion such as specification, as shown in figure 2.6 (NBS, 2013). These predefined objects can be modified and applied directly to building designs (Jiang, 2011). Thus, it is worthwhile to store common information on these identical parts in a standard part description and store them in library (Underwood & Isikdag, 2010).

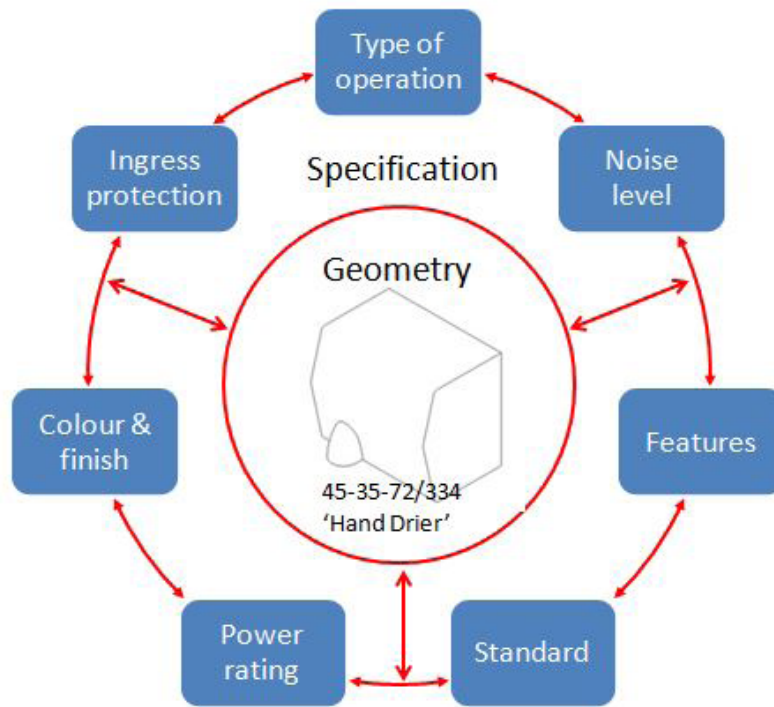

Figure 2.6: Information structuring in a BIM model (NBS, 2013)



The concept of standard part libraries is applied in Building Information Modelling, for example, some BIM tools have their own library, such as ArchiCAD which relies on GDL scripting language to define parametric objects and includes comprehensive object libraries that are organized by system for its users: wood, metals, plumbing, precast concrete, HVAC, thermal and moisture protection, masonry and so on (Eastman et al., 2011).

Similarly, Revit has a large set of object libraries, especially its own Autodesk (SEEK) library for design objects and specification. It contains more than 13,750 various objects and information for approximately 850 different firms. These objects are defined in different file types such as TXT, IES, DGN, SKP, GSM, DWG, RVA and DWF (Eastman et al., 2011). In addition, some websites such as RevitCity (<http://www.revitcity.com>) provides users with predesigned BIM objects in CSI MasterFormat 04, as shown in figure 2.7 (Jiang, 2011).

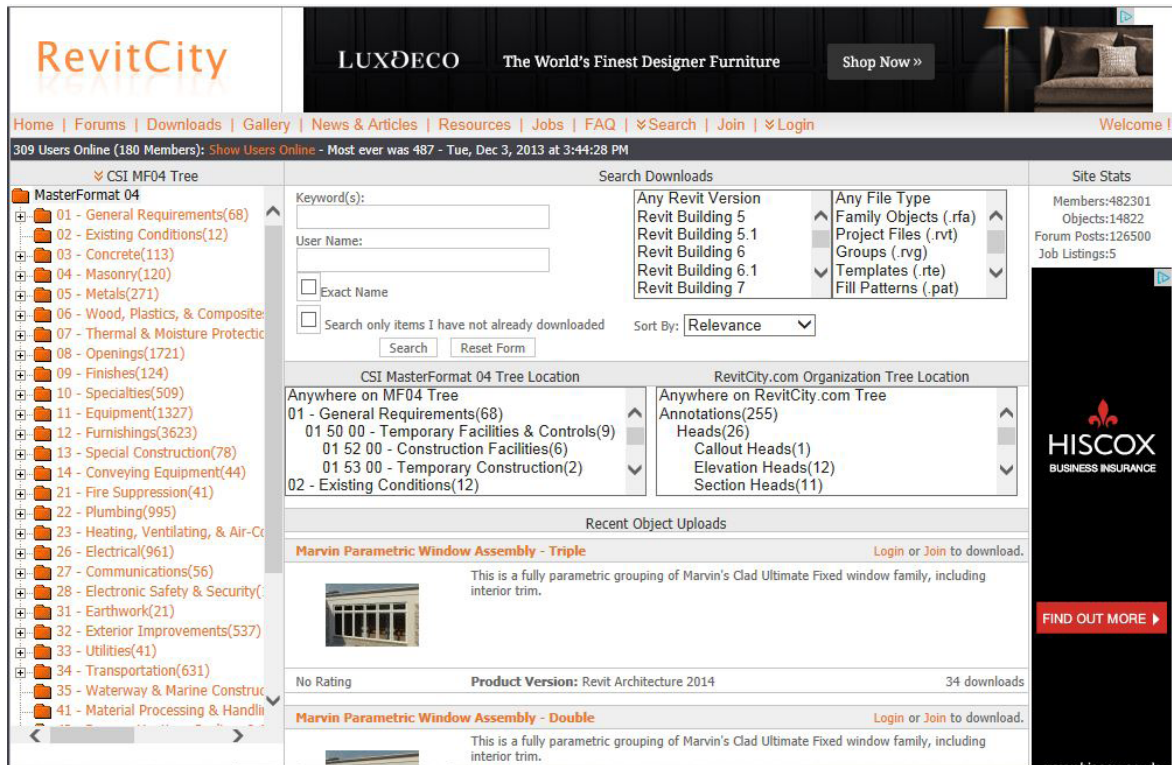

Figure 2.7: Snapshot of RevitCity website (www.revitcity.com)

Furthermore, the National BIM library (<http://www.nationalbimlibrary.com/>) from NBS provides a free online resource to locate and download generic BIM objects from a wide range of products and systems such as roofs, walls, windows, doors etc. The objects in the National BIM library are categorized according to system name and uniclass to give a detailed level of connection between the specification and objects. The library has input from Tekla, Graphisoft, Nemetschek, Bentley, Autodesk and IFC (NBS, 2013).

There is also another BIM library called BIMObject (<https://bimobject.com/>). This plays a global role in providing free downloadable BIM components from over 16,500 manufacturers who pay BIMObject to create intelligent 3D objects with different formats, such as Tekla, Revit, Bentley and ArchCAD (AECMAGAZINE, 2013).

All in all, as BIM improves and expands, more BIM objects are created. Designers can use these objects, as opposed to designing new BIM objects by themselves which, in turn, helps them save time (Jiang, 2011).

2.7 Interoperability

As indicated earlier, there is no super BIM tool that includes all functions to facilitate the technological implementation of BIM. Therefore, BIM models should be created and developed by using various BIM applications during the various stages of the building lifecycle processes. For that purpose, the BIM models must be exported and imported smoothly among different BIM applications to achieve better performance (Wang, 2011). In other words, BIM software packages should talk to each other to define a building project, bring automation and integrate the design and construction processes in an integrated way. As a result, such a successful interoperability between BIM applications would give the AEC industry better chances for working together (Sheata, 2011).

Interoperability is the ability to exchange data between applications to streamline workflows and facilitate automation (Eastman et al., 2011). A survey by McGraw-Hill Construction (2007) revealed that a lack of interoperability can affect the workflow of the project community and reflect on project budget, that is to say, approximately 3.1% of project costs are associated with the lack of interoperability between software applications. Furthermore, the survey showed that manual data re-entry from one application to another is the highest portion of the cost which is then followed by time spent on duplicate software; time lost to document version checking, money for data translators, and increased time processing requests for information. These interoperability related cost concerns are illustrated in figure 2.8. A lack of interoperability can lead to project delays, misinterpretations of building system conflicts and errors (Forbes and Ahmed, 2011).

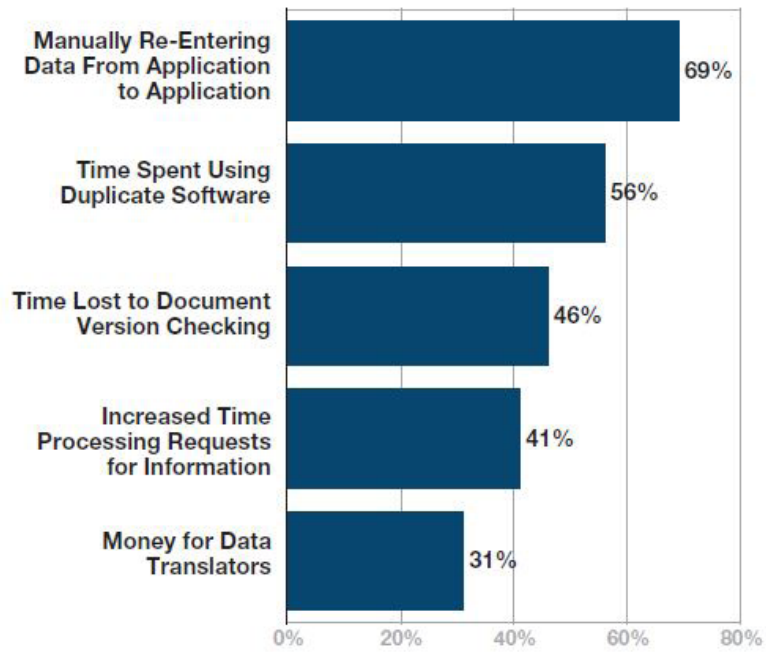

Figure 2.8: Key concerns regarding the lack of interoperability (McGraw-Hill Construction, 2007)

www.sylvania.com

We do not reinvent the wheel we reinvent light.

Fascinating lighting offers an infinite spectrum of possibilities: Innovative technologies and new markets provide both opportunities and challenges. An environment in which your expertise is in high demand. Enjoy the supportive working atmosphere within our global group and benefit from international career paths. Implement sustainable ideas in close cooperation with other specialists and contribute to influencing our future. Come and join us in reinventing light every day.

Light is OSRAM

OSRAM SYLVANIA



There is a considerable amount of software programmes used in AEC applications and licenses are usually required to open a particular file for information sharing between those AEC applications which can make collaboration very difficult between project team members (Sheata, 2011). Eastman et al. (2011) recommended that there are three main ways of exchanging data between two software programmes:

- **Direct links** between two software programmes through the API (Application Programming Interface) of one software to extract information which can then be re-written by the receiving software's API. Some software firms prefer to use a direct link or proprietary interfaces to specific software such as Bentley's MDL, Revit's Open API and Archicad's GDL.
- **Proprietary exchange format:** a file based data exchange approach which can be created by a commercial organization to support its own software product, for example, DXF (Data eXchange Format) is a well-known proprietary exchange format in the construction industry. It has been developed by Autodesk to enhance the information exchange between software packages. Other proprietary exchange formats such as 3DS, STL, ACIS and SAT have been defined by commercial organizations to deal with the different functions of their software programmes.
- **The public product data model exchange formats:** this relies on an open and publicly managed language and schema such as text file and XML. A list of the most common exchange formats in the construction industry is listed in table 2.3.

On the other hand, IFC (Industry Foundation Classes) was created by the BuildingSMART Alliance for data exchange between different BIM programmes (Thomassen, 2011). IFC depends on the ISO-STEP EXPRESS language (Eastman et al., 2011) and it is designed to address all building information throughout the whole lifecycle of a building, from conception through design and construction to operation (Norberg, 2012). Nevertheless, IFC is still not mature and has some problems when exporting or importing BIM models (Gaudin, 2013; Monteiro & Martins, 2012).

All in all, interoperability between BIM tools, if successfully enabled, can improve value for clients, expand markets for firms, decrease supply chain communication costs, increase overall speed of projects, provide greater reliability of information throughout the lifecycle, and reduce infrastructure vulnerability (McGraw-Hill Construction, 2007).

Image (Raster) Formats: JPG, GIF, TIF, BMP, PNG, RAW, RLE	Raster formats vary in terms of compactness, number of possible colours per pixel, transparency, compression with or without data loss
2D Vector Formats: DXF, DWG, AI, CGM, EMF, IGS, WMF, DGN, PDF, ODF, SVG, SWF	Vector formats vary regarding compactness, line formatting, colour, layering and types of curves supported; some are file based, others use XML
3D Surface and Shape Formats: 3DS, WRL, STL, IGS, SAT, DXF, DWG, OBJ, DGN, U3D, PDF(3D), PTS, DWF	3D Surface and shape formats vary according to the types of surfaces and edges represented, whether they represent surfaces or solids, material properties of the shape or view point information. Some have both ASCII and binary encodings. Some include lighting, camera and other viewing controls; some are file formats and others XML
3D Object Exchange Formats: STP, EXP, CIS/2, IFC	Product data model formats represent geometry according to the 2D or 3D types represented; they also carry out object type data and relevant properties between objects. They are the richest in information content.
AecXML, Obtn, AEX, bcXML, AGCxml	XML Schemas developed for building data; they vary according to the information exchanged and the workflow supported
V3D, X,U, GOF, FACT, COLLADA	A wide variety of game file formats varying according to the types of surfaces, whether they carry hierarchical structure, types of material properties, texture and bump map parameters, animation, and skinning
SHP, SHX, DBF, TIGER, JSON, GML	Geographical Information System formats in terms of 2D or 3D, data links supported, file formats, and XML

Table 2.3: Information Exchange formats commonly used in AEC (Eastman et al., 2011)

2.8 Free BIM Tools

The use of free BIM tools can be also the assist in improving design and construction workflows. Thus, some free software is introduced in this section. In the market, it is possible to find different free software that can support processes. Given the large amount of software available, it is necessary to group them into core themes such as modelling tools, viewers, servers, cost estimation and plugins/other. These are elaborated below.

2.8.1 3D Modelling Tools

Trimble Sketchup 2013 (previously called Google Sketchup) is a 3D modelling tool but it is not a BIM tool. It is a 3D modelling tool without parametric rules embedded within it. Thus, it is not possible to add or extract information from such models. However, Sketchup is useful for a quick visualization of design intent (Eastman et al., 2011).

2.8.2 Viewers

There are many different viewers for BIM models. However, their strengths and weaknesses vary depending on needs and certain functions. Thus, it is important to choose the right viewer for the right task. The most popular viewers are elaborated upon and compared below.

Autodesk Design Review: it is possible to carry out design checks using mark ups, adding comments and suggestions for design changes on the drawings and 3D models. However, interoperability is its biggest problem in that it does not support IFC or BCF files and can only read DWF format. On the other hand, from the usability point of view, the interface is clear and easy to use; although the navigation is not the best (Autodesk, 2013).

DDS CAD: This is an integrating tool for the analysis of multiple files at same time. It is possible to run clash detection, but the option to use this is not straightforward. On the other hand, interoperability is the main advantage of this viewer due to the adoption of open standard files such as IFC, BCF and gbXML which makes the exchange of information with other tools possible. However, it has some drawbacks too, for example, importing from authoring software using IFC is not the best; the colour of elements is lost and it is necessary to change them manually within DDS CAD. On the other hand, it is easy to use with a user-friendly interface in terms of usability.



360°
thinking.

Deloitte.

Discover the truth at www.deloitte.ca/careers

© Deloitte & Touche LLP and affiliated entities.



Navisworks Freedom: this viewer is very limited since it only allows a review of any modifications made in Navisworks Manage. However, it is possible to see saved viewpoints, comments, redlines and measures. On the other hand, it is not possible to reply to comments or save any change in the model, while only NWD and 3D DWF files can be reviewed. Finally, it is easy to use from the usability perspective (Autodesk, 2014).

Solibri Model Viewer: it has features for measuring and taking notes even though they are not straightforward to learn and use. Regarding interoperability, it supports IFC, IFCzip but it does not support BCF files. Thus, it is not possible to import or export the data generated by the mark-up tools. However, it is possible to save the changes made in the model but only by using the native file format of Solibri (SMC). Finally, from the usability point of view, it is very simple to use with a user-friendly interface (Solibri, 2014).

Tekla BIMsight: it is a great facilitator of collaboration, for the integration of multiple models for clash detection, for taking notes and information sharing. It also helps to measure and generate section views. It is also possible to share models via a cloud service as Dropbox or Gdrive for collaborative working. In terms of interoperability, it can read IFC, IFCzip, BCF and BCFzip files. It is pretty straightforward and easy to use from the usability point of view (Tekla, 2013).

xBIM Explorer: this is a viewer which allows the integration of multiple files. It supports IFC, IFCzip and COBie file formats. However, when multiples files are imported, they are become grey in colour and it is not possible to change this. It is very simple to use.

BIMserver: This is an open server for uploads, downloads and for queries of IFC files. It is also possible to run clash detection. However, the interface is not user friendly and most of the time the BIM model is not visible in the interface which makes it difficult to understand (Eastman et al., 2011).

2.8.2.1 How to Choose a BIM Viewer

The selection of the most appropriate BIM viewer (amongst the large number of BIM viewers available in the market) is critical for an effective contribution to the design and construction process workflows. This selection can be carried out by assessing three characteristics:

- o Features: this refers to the different functions of the BIM viewers available for use
- o Interoperability: this concerns the capability of the viewer in supporting different formats to allow information exchange between different applications
- o Usability: this concerns how user-friendly a BIM viewer is and how easy it is to use it/learn how to use it.

The characteristics of each viewer previously discussed are summarized in table 2.4.

	Autodesk Design Review	DDS CAD	Navisworks Freedom	Solibri Model Viewer	Tekla BIMsight	xBIM Xplorer
Features						
Soft clashes					x	
Hard clashes		x			x	
Manage of clashes					x	
Mark up	x	x		X	x	
Attach documents					x	
Different visualizations	x	x	x	X	x	
Multiple models		x			x	x
Save changes	x	x	x	X	x	x
Measure tool	x	x	x	X	x	
4D						
Colours	x	x		X	x	
Interoperability						
IFC		x		X	x	x
IFCzip		x		X	x	x
BCF		x			x	
BCFzip		x			x	
GBxml		x				
Cobie						x
Usability						
Clear interphase	x		x	X	x	x
Simple navigation	x	x	x	X	x	x
Easy to use	x	x	x	X	x	x

Table 2.4: Main characteristics of BIM viewers

Table 2.4 shows that Tekla BIMsight has relatively more features and high interoperability as compared to the others. It also has good usability. It is followed by DDS CAD. While at the opposite end are Navisworks Freedom and xBIM Xplorer which seem to have less features than the others such as Solibri and Autodesk Design review. However, xBIM Xplorer is the only one that can export data into a COBie spreadsheet.

2.8.3 Cost estimation

SkyBIM Estimator: this is the newest software released in late 2013. It is a real time cost estimator that links a Revit model with a cost database in the cloud. Every change in the Revit model will be reflected in the cost database hosted in the cloud. The estimators will have access to the latest take-off quantities. It can be used in the bidding process by contractors to compare various bidding proposals. However, the problem with this software is that it does not work very well in an operative system of 64bit and most BIM tools require 64bit computer specifications for smooth running. Furthermore, there are, currently, no real life project cases demonstrating the effective use of this tool (SkyBIM, 2014).

2.8.4 Plugin Tools

Plugin tools are sets of tools that can support the use of the aforementioned BIM tools.

- o **IFC-File analyser:** developed by buildingSMART to extract data from an IFC file and put it into an excel spreadsheet. In addition, it is possible to compare attributes between multiple IFC files.
- o **IFC Exporter:** it is a plugin for Revit to export IFC/IFCzip files setting specific characteristics to export, for example by floor, phase, element, etc.
- o **BCF viewer:** this is a reader of BIM Collaboration Format (BCF) files generated by other BIM tools such as DDS CAD, Solibri Model Checker or Tekla BIMsight.
- o **Tekla BIMsight Note:** this is another BCF reader for mobile devices.

SIMPLY CLEVER

ŠKODA



We will turn your CV into
an opportunity of a lifetime



Do you like cars? Would you like to be a part of a successful brand?
We will appreciate and reward both your enthusiasm and talent.
Send us your CV. You will be surprised where it can take you.

Send us your CV on
www.employerforlife.com



- o **Solibri IFC Optimizer:** this is plugin tool for the optimization of an IFC file while eliminating redundant data and reducing the file size up to 95%.
- o **Cloud services:** these are free cloud hosts like Dropbox, Gdrive or Box that allows the sharing of information.
- o **DRIVEeye:** this is a configurable plugin that sends a notification every time someone changes or deletes a file in a shared folder in the cloud.
- o **Syncbackup:** this is a configurable application for automatic backups from the data in the cloud.

2.9 References

AECMAGAZINE, (2013), BIM Libraries, Retrieved 28 March 2014, from <http://aecmag.com/comment-mainmenu-36/566-bim-libraries>.

Akcamete, A., Akinci, B. & Garrett, J.H. (2010), Potential utilization of building information models for planning maintenance activities. In *Proceedings of the international conference on computing in civil and building engineering: 30 June–2 July 2010*, (pp. 151–157). Nottingham, UK. Retrieved from <http://www.engineering.nottingham.ac.uk/iccbe/proceedings/html/76.htm>

Arayici, Y., Khosrowshahi, F., Ponting, A.M. & Mihindu, S. (2009), Towards implementation of building information modelling in the construction industry, In *Fifth International Conference on Construction in the 21st Century (CITC-V) “Collaboration and Integration in Engineering, Management and Technology”*: 20–22 May 2009, Istanbul, Turkey. Retrieved from <http://usir.salford.ac.uk/20702/>

Autodesk (2003), Building Information Modelling in Practice: White Paper, Retrieved From http://www.ddscad.com/BIM_In_Practice.pdf.

Autodesk (2008), BIM and Facilities Management: White Paper, Retrieved From http://www.arc-corporate.com/_pdf/bim_and_fm_whitepaperv3.pdf.

Autodesk (2013) Autodesk Design Review, Retrieved 01 May, 2014, from <http://usa.autodesk.com/design-review/>

Autodesk (2014b) Autodesk Navisworks Freedom, Retrieved 01 May, 2014, from <http://www.autodesk.com/products/autodesk-navisworks-family/autodesk-navisworks-freedom>.

Azhar, S. & Brown, J. (2009), BIM for sustainability analysis, *International Journal of Construction Education and Research*, 5(4), 276–292, doi: 10.1080/15578770903355657.

Azhar, S., Brown, J. & Farooqui, R. (2009), BIM-based sustainability analysis: An evaluation of building performance analysis software. In *Proceedings of the 45th ASC Annual Conference*, Retrieved from <http://ascpro.ascweb.org/chair/paper/CPRT125002009.pdf>.

Azhar, S., Khalfan, M. & Maqsood, T. (2012), Building information modelling (BIM): now and beyond. *Australasian Journal of Construction Economics and Building*, 12(4), 15–28.

Azhar, S., Nadeem, A., Mok, J.Y. & Leung, B., (2008), Building Information Modelling (BIM): A new paradigm for visual interactive modelling and simulation for construction projects. In *Proc., First International Conference on Construction in Developing Countries: 4-5 August 2006*, (pp. 335–346). Karachi, Pakistan, Retrieved from <http://www.neduet.edu.pk/Civil/ICCIDC-I/Complete%20Proceedings.rar#page=446>.

Beyond the Paper, (2006), FMDesktop Components, Retrieved 5 April 2014, from http://dwf.blogs.com/beyond_the_paper/2006/10/fmdesktop_compo.html

Brewer, G., Gajendran, T. & Goff, R.L. (2012), Building Information Modelling (BIM): an Introduction and International Perspectives: Research report, Retrieved from <http://www.tbciitb.com.au/>.

Chen, D. & Gehrig, G.B. (2011), Implementing Building Information Modelling in Construction Engineering Curricula, *American Society for Engineering Education*, Retrieved from <http://www.asee.org/public/conferences/1/papers/96/download>.

Eastman, C., Teicholz, P., Sacks, R. & Liston, K. (2011), *BIM Handbook: A Guide to Building Information Modeling for Owners, Managers, Designers, Engineers, and Contractors*. (2nd ed.). Hoboken, N.J.: Wiley.

Forbes, L. & Ahmed, S. (2010), *Modern Construction: Lean Project Delivery and Integrated Practices (Industrial Innovation Series)*. (1st ed.). US: CRC Press.

Foundation of the Wall and Ceiling Industry, (2009), Building Information Modelling: Understanding and Operating in a New Paradigm, Retrieved from <http://www.awci.org/pdf/bim.pdf>.

Gardezi, S.S.S., Shafiq, N. & Khamidi, M.F.B. (2013), Prospects of Building Information Modelling (BIM) in the Malaysian Construction Industry as a Conflict Resolution Tool, *Journal of Energy Technologies and Policy*, 3(11), 346–350.

Gaudin, B. (2013), *Impacts of Building Information Modelling (BIM) on Project Management in the French Construction Industry*, (MSc thesis), University of Birmingham, Birmingham.

Hardin, B. (2009), *BIM and Construction Management: Proven Tools, Methods, and Workflows*, San Francisco, California: John Wiley.

Hergunsel, M.F. (2011), *Benefits of building information modelling for construction managers and BIM based scheduling*. (MSc thesis), Worcester Polytechnic Institute, Worcester, Retrieved from <http://www.wpi.edu/Pubs/ETD/Available/etd-042011-135239/>

Jiang, X. (2011), *Developments in cost estimating and scheduling in BIM technology*, (MSc thesis), Northeastern University, Boston, Massachusetts.

Khemlani, L. (2007), Autodesk FMDesktop: Extending BIM to Facilities Management, Retrieved 5 April 2014, <http://www.aecbytes.com/buildingthefuture/2007/FMDesktop.html>

Krygiel, E. & Nies, B. (2008), *Green BIM: Successful Sustainable Design with Building Information Modelling*, (1st ed.). Canada: Wiley.

Latiffi, A.A., Mohd, S., Kasim, N. & Fathi, M.S. (2013), Building Information Modelling (BIM) Application in Malaysian Construction Industry, *International Journal of Construction Engineering and Management*, 2(4A), 1–6. doi: 10.5923/s.ijcem.201309.01.

I joined MITAS because
I wanted **real responsibility**

The Graduate Programme
for Engineers and Geoscientists
www.discovermitas.com



Real work
International opportunities
Three work placements



Month 16
I was a construction
supervisor in
the North Sea
advising and
helping foremen
solve problems





Liu, Q., Gao, T. & Wang, J. (2011), Research on application of BIM technology in construction project, In *Computer Science and Service System (CSSS), International Conference on: 27–29 June 2011*, (pp. 2463–2467), IEEE, doi: 10.1109/CSSS.2011.5974366.

Lucas, J., Thabet, W. & Bowman, D. (2009), Analysing capacity of BIM tools to support data use across project lifecycle, *Managing IT in construction/managing construction for tomorrow*, 26, 11–18, Retrieved from <http://itc.scix.net/data/works/att/w78-2009-1-54.pdf>.

Marsh, A. (2003), ECOTECT and EnergyPlus, *Building Energy Simulation User News*, 24(6), 2–3.

McGraw-Hill Construction, (2007), Interoperability in the construction industry: SmartMarket Report, Retrieved from www.aia.org/aiaucmp/groups/aia/documents/pdf/aia077485.pdf

McGraw-Hill Construction, (2008), Building Information Modelling (BIM): Transforming Design and Construction to achieve greater industry productivity, SmartMarket Report. <http://www.asti.com/>.

Moakher, P.E. & Pimplikar, S.S. (2012), Building Information Modelling (BIM) and Sustainability – Using Design Technology in Energy Efficient Modelling, *IOSR Journal of Mechanical and Civil Engineering (IOSRJMCE)*, 1(2), 10–21, <http://www.iosrjournals.org/>

Monteiro, A. & Martins, J.P. (2012), SIGABIM: a framework for BIM application, In *Proceedings of the XXXVIII IAHS World Congress, 16–19 April*, Istanbul Technical University, Turkey.

National Research Council of Canada, (2011), Environmental Scan of BIM Tools and Standards, <https://www.abc-bim.ca/>

NBS, (2013), Building Information Modelling, Retrieved 28 March 2014, from <https://www.thenbs.com/topics/BIM/articles/aPicturePaintsThousandWords.asp>

Norberg, A. (2012), *Implementing Building Information Modelling within the railway sector*, (MSc thesis), Chalmers University of Technology, Sweden, Retrieved from <http://publications.lib.chalmers.se/records/fulltext/161339.pdf>.

Penttila, H. (2009), Introduction to BIM – What makes a BIM-project?, Retrieved 8 February 2014, from http://www.mittaviiva.fi/hannu/BIM_project/index_bim_basics_en.html

Sheata, W. (2011), *Identifying the areas where Building Information Modelling software adds value for general contractors working in the State of Colorado*, (MSc thesis), Colorado State University, US, <http://digitool.library.colostate.edu/webclient/DeliveryManager?pid=122953>

Sistani, N.S. (2013), *An Investigation of Building Information Modelling Application in Design-Bid-Build Projects*, (MSc thesis), Eastern Mediterranean University, Gazimağusa, North Cyprus.

SkyBIM (2014) SkyBIM Estimator, Retrieved 2 May 2014, www.skybim.com/estimator/BIMHighway%20Estimator%20User%20Guide%20HTML/index.html

Solibri (2014), Solibri Model Viewer, Retrieved 2 May 2014, <http://www.solibri.com/products/solibri-model-viewer/>

Tekla (2013), Learn more, Retrieved 2 May 2014, <http://www.teklabimsight.com/learn-more>

Thomassen, M. (2011), *BIM and Collaboration in the AEC Industry*, (MSc thesis), University of Aalborg, Denmark, http://vbn.aau.dk/files/55376698/BIM_Collaboration_in_the_AEC_Industry_by_Mats_Thomassen.pdf

Underwood, J. & Isikdag, U. (2010), *Handbook of Research on Building Information Modelling and Construction Informatics: Concepts and Technologies*, Hershey, PA: Information Science Reference.

Wang, M. (2011), *Building Information Modelling (BIM): Site-Building Interoperability Methods*, (MSc thesis), Worcester Polytechnic Institute, US, Retrieved from <https://www.wpi.edu/Pubs/ETD/Available/etd-090711-090955/unrestricted/mwang.pdf>.

3 Process

3.1 Introduction

Traditionally, the design and construction process is one that is generally presented in terms of its main participants. Indeed the many descriptions of the process rely more upon presenting the roles and responsibilities of the parties involved, rather than the stages through which the process must pass.

Typically, the construction process is described as one in which a client commissions an architect or engineer to facilitate the project process. The architect/engineer obtains a set of requirements and, through refining the requirements in the brief from the client; they set out the main performance attributes of the construction facility required. Following this, other consultants (specialist designers, engineers and cost consultants) work with the architect/engineer, as a design team, to develop a design solution to meet the client's requirements. The design is developed through several stages, including concept, feasibility, outline and detailed design. Documents relating to the technical specification of the design, its cost and construction duration are produced at each stage of the design process.

ie business school

#1 EUROPEAN BUSINESS SCHOOL
FINANCIAL TIMES 2013

#gobeyond

MASTER IN MANAGEMENT

Because achieving your dreams is your greatest challenge. IE Business School's Master in Management taught in English, Spanish or bilingually, trains young high performance professionals at the beginning of their career through an innovative and stimulating program that will help them reach their full potential.

- Choose your area of specialization.
- Customize your master through the different options offered.
- Global Immersion Weeks in locations such as London, Silicon Valley or Shanghai.

Because you change, we change with you.

www.ie.edu/master-management | mim.admissions@ie.edu |

Download free eBooks at bookboon.com



Click on the ad to read more

Following completion of the detailed design stage, the documents produced are used to facilitate a tendering process by which a contractor is selected to carry out the construction of the project, as designed. A contractor wishing to tender for the project reviews the tender documents and calculates a price for carrying out the construction work, to the required specification and time. Each contractor then submits his price for the work to the client, who (with the assistance of the design team) selects the best bid from those submitted. Once appointed the contractor will, for some or all of the work, subcontract the project to various specialist or trade subcontractors.

Such a description of the design and construction process may be considered fairly common, in the sense that it is heavily loaded with roles and responsibilities attributed to one or more individuals in the process. A much more comprehensive example is the range of 'procurement' options through which a construction project may be obtained. These are very briefly described below.

Traditional – design by consultants is completed before the contractors tender for, then carry out, the construction.

Construction Management – design by the project sponsor's consultants and construction overlap. A fee earning construction manager defines and manages the work packages. All contracts are between the construction manager and the trade contractors. The final cost of the project can only be accurately forecast when all packages have been let.

Management Contract – design by the project sponsor's consultants and construction overlap. A management contractor is appointed early to let elements of work progressively by trade or package contracts. The contracts are between the management contractor and the trade contractors. Similar to the construction management, the final cost can only be accurately forecast when the last package is let.

Design and Manage – similar to the management contract, with the contractor also being responsible either for detailed design or for managing the detailed design process.

Design and Build – detailed design and construction are both undertaken by a single contractor in return for a lump sum price. Where a concept design is prepared before the contractor is appointed, the strategy is called Develop and Construct.

The descriptions above, whilst brief, demonstrate the widespread process definitions and the participants involved. However, this approach makes comparison with other industries difficult and, furthermore, makes attempts at identifying clear areas for improvement difficult. The quotation below from the UK Government's Rethinking Report addresses these difficulties in participant-led process definitions in construction and presents an entirely different perspective of construction processes, stimulated by consumer-led manufacturing and service industries.

“...the Task Force wishes to emphasise that we are not asking construction to look at what it does already and do it better: we are asking the industry...to do it entirely differently. What we are proposing is a radical change in the way we build. We wish to see, within five years, the construction industry deliver its products to its customers in the same way as the consumer-led manufacturing and service industries. To achieve the dramatic increases in efficiency and quality that are both possible and necessary we must **rethink construction**” (Egan, 1998).

One of the original concerns of the Rethinking Construction report was to increase efficiency in production and, consequently, to lower costs and raise profits in construction. It was also intended that workers would receive higher salaries with the increase in productivity.

While in large companies production may represent a complete department, in small companies various organisational functions can be found concentrated on a single person. Therefore, production cannot be classified as being synonymous with the traditional ‘production department’. Contemporarily, companies need to break down their traditional departmental barriers to create cross-functional teams to tackle difficult problems. The core issue in this fundamental change is the shift from departments-based structuring to business process structures – such as strategic formulation, product development, and order fulfilment. Figure 3.1 illustrates the business process crossing organisational functions.

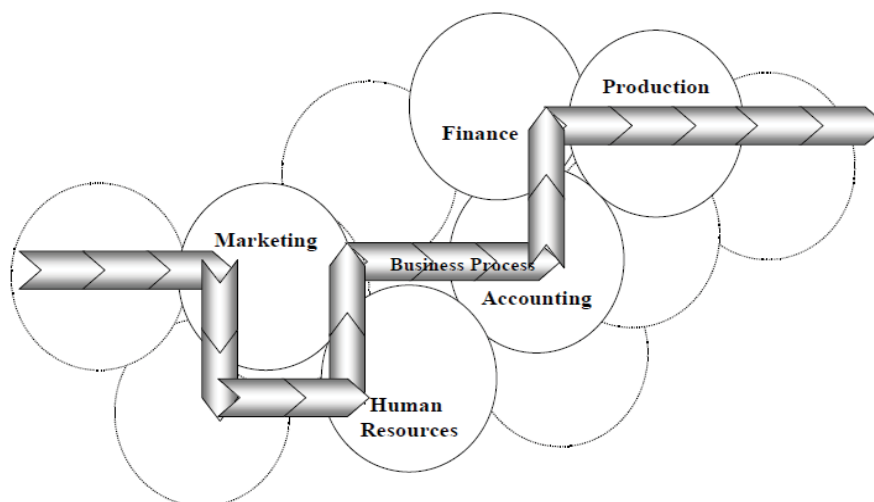

Figure 3.1: Production as Part of the Business Process

In general terms, the earlier a decision is taken in the business process the higher its potential impact on competitive variables, such as cost and time. This is illustrated in the Figure 3.2. A review of what is to be produced to satisfy the client’s requirements at the ‘briefing stage’ may have much more impact than difficult and costly efforts in production. Thus, this reinforces the need to consider the impacts of the decisions in production in relation to the whole of the business process if it is to contribute to the competitiveness of the organisation.

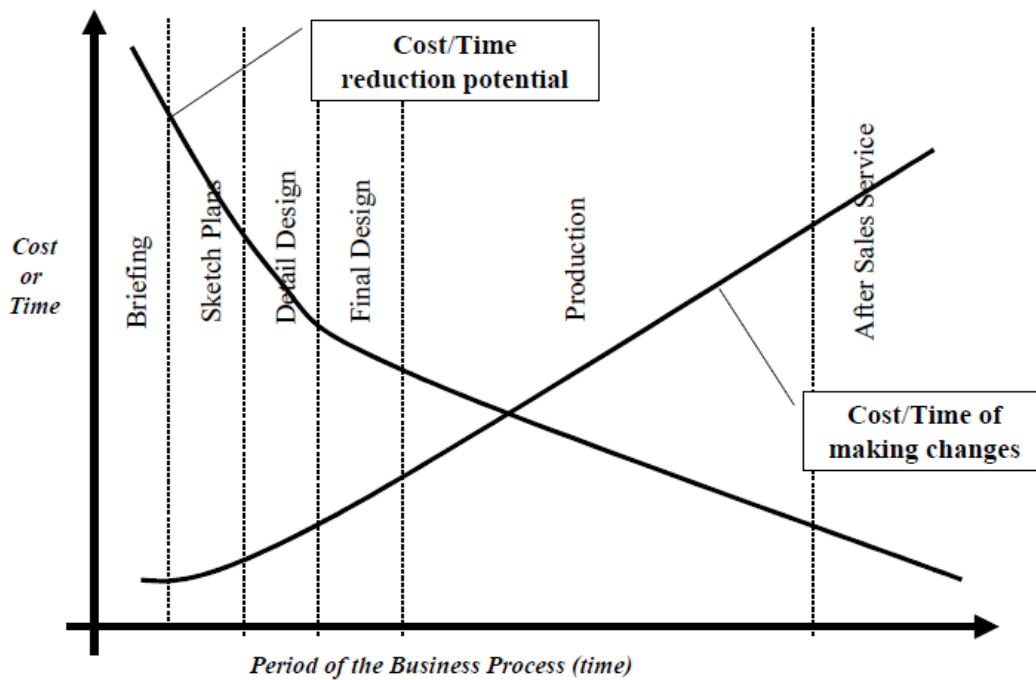

Figure 3.2: Cost/time reduction potential versus cost/time of making changes

“I studied English for 16 years but...
...I finally learned to speak it in just six lessons”
Jane, Chinese architect

ENGLISH OUT THERE

Click to hear me talking before and after my unique course download



Processes have not always been recognised because they are covered by the superimposed traditional departmental organisational structure. As the process driven perspective permeates the industry, the benefits of reorganising the main value-adding processes, increasing the focus of decisions and promoting positive interactions among the various organisational functions becomes more evident. The production function has an important role in this context as most of the resources of the company pass through its processes. Since the end-product in construction is a building, the production function here is the Building Information Modelling (BIM) throughout the business process.

From the production perspective, the challenge is to find ways of implementing strategic thinking in its internal decisions. Often there is a lack of coherence and mutual support between the production function and the other organisational functions and, even worse, between production decisions and the business strategy.

A production strategy can be defined as *the collective pattern of coordinated decisions that act upon the formulation, re-formulation and deployment of production resources in order to provide a competitive advantage in support of the overall business strategy.*

Production strategy is a critical component within world class companies. Its basic ideas are:

- production can be a strong competitive resource;
- cost, efficiency and productivity are generally too narrow and limited and, paradoxically, self-defeating to create competitive advantage;
- other performance objectives should be considered such as, delivery lead-times, quality, service, reliability, flexibility for product change, flexibility for volume change and investment required.

A production strategy is defined in accordance with competitive variables relating to the business requirements. The basic and most mentioned competitive variables are cost, quality, delivery and flexibility. The literature also describes a number of variations and alternative competitive variables: speed, consistency, agility, innovativeness, diversity, speed of production changes and uniqueness, safety and morale.

3.2 Uses of BIM

BIM as Building Information Modelling and Management occurs throughout the building lifecycle including planning, design, construction and operation, in various capacities, in order to achieve the desired results. Such BIM usage refers to the specific methods of implementing BIM throughout the lifecycle that CIC (2012) in the Computer Integrated Construction Research Programme (CIC, 2012) elaborated upon; i.e. BIM usage being the methods or strategies of applying Building Information Modelling during a facility's lifecycle to achieve one or more specific objectives, including being used for generating, processing, communicating, executing and managing information about the facility.

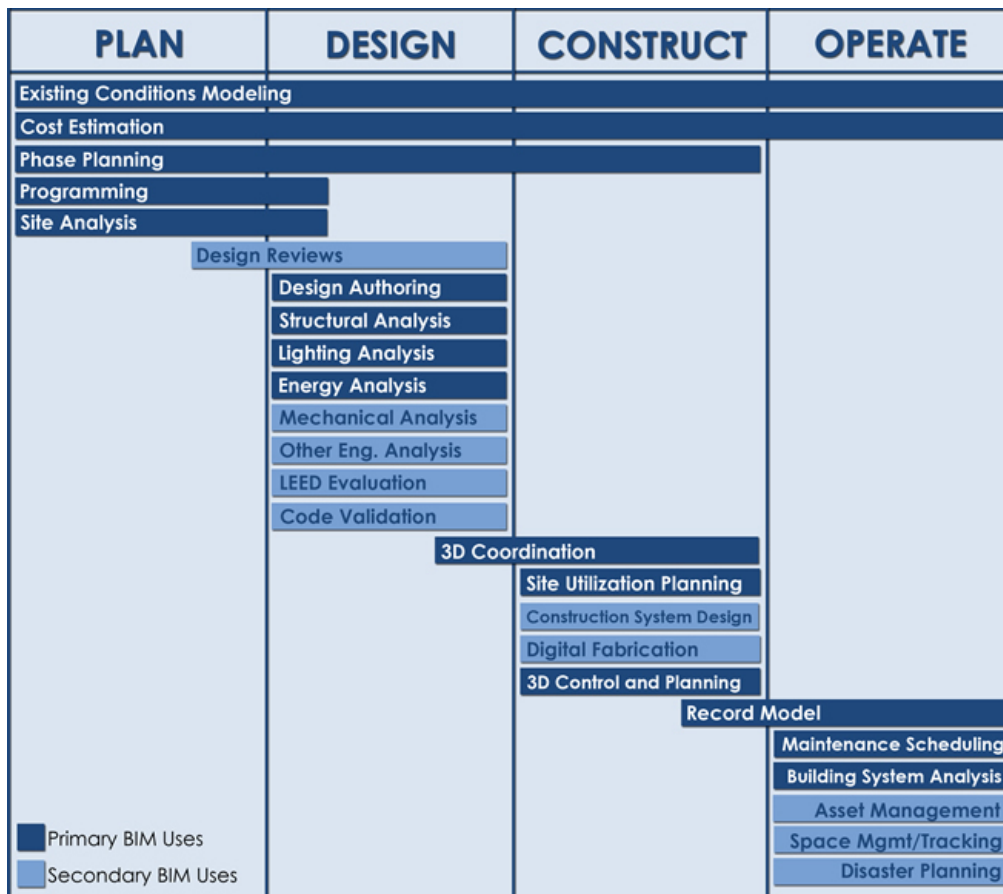

Figure 3.3: Uses of BIM in the lifecycle (CIC, 2012)

Common uses of BIM as identified by CIC (2012) are classified into four major categories, namely Planning, Design, Construction and Operation. For each of these major stages in a project, BIM offers up-to-date and accessible information. These four categories are further sub-divided. The diagram above briefly shows the primary and secondary uses of BIM throughout the lifecycle of a facility.

3.2.1 Planning Phase

At the planning phase, an architect should gather information for planning and a feasibility analysis to determine any external factors and constraints that would affect the design, for example, as-built information in case of a renovation/restoration/remodelling project, a site analysis to include topography, prevalent wind directions, the daily and annual sun path; all of which can affect the size and orientation of the building design. BIM use in this phase can ensure that all this information can be integrated in a BIM model to perform an early conceptual design analysis, to arrange the information in phases, to produce design alternatives in good time, to obtain quick cost estimates and to draft a programme of completion.

3.2.2 Design Phase

Throughout the design process, the architect should maintain a balance for the scope, schedule and cost in line with the client's budget and requirements. Any untimely change can cost money and extra time. Using traditional methods, it usually takes a lot of time and effort to produce cost estimating and scheduling information. However, with the use of BIM, all the design documents, schedules, quantities and other vital information are immediately made available from a single source. This puts the designer and project team in firm control for accurate design making, in a collaborative way, more quickly and effectively without painstaking manual checking. This gives the design team time to work on significant architectural problems. In addition, building design and documentation can be undertaken simultaneously as the work progresses instead of in sequence (Autodesk, 2003). The information that is available through using BIM improves the ability to make decisions faster requiring less time and effort, thereby, increasing the speed of delivery, improving coordination and decreasing costs – resulting in greater productivity, higher quality work and an increase in the profit margins within projects for all stakeholders.

Excellent Economics and Business programmes at:



university of
 groningen



**“The perfect start
of a successful,
international career.”**

CLICK HERE
to discover why both socially
and academically the University
of Groningen is one of the best
places for a student to be

www.rug.nl/feb/education



3.2.3 Construction Phase

BIM is also indispensable in the construction phase. With synchronised and accurate design development with BIM, scheduling and cost information becomes available to the construction team at the construction stage, which accelerates a timely and effective progress within the construction execution. The contractor can communicate logistical information to quickly prepare plans showing renovation phasing or how the site will be utilised, improving construction operations through the use of BIM. This results in better construction planning, less time and money spent and assists in avoiding any overhead costs.

3.2.4 Management Phase

In the management phase, BIM provides support to facility managers by providing valid information such as the performance and operational matrix necessary for the management of a facility. With the use of BIM, physical information such as a furniture and equipment inventory, finishes, leasable areas, tenant and rental income are made easily available and thus better managed by the facility manager. Access to this type of information improves revenue, cost management and the overall operation of the building.

3.3 Business process re-engineering

Business Process Reengineering (BPR) entails on-going incremental actions aiming to increase efficiency and to add value to processing activities and to promote the reduction of non-value adding activities. Continuous improvement is at the core of BPR with philosophies relating to production strategy. These include focusing on the customer, a shared responsibility for quality, a team problem-solving approach, fact-based management and the regular training of employees. Health, safety and environmental aspects also benefit strongly from continuous improvement. One of the premises of continuous improvement is not to accept established knowledge as the ultimate truth. It is commonly associated with the Plan-Do-Check-Act cycle as shown in Figure 3.4.

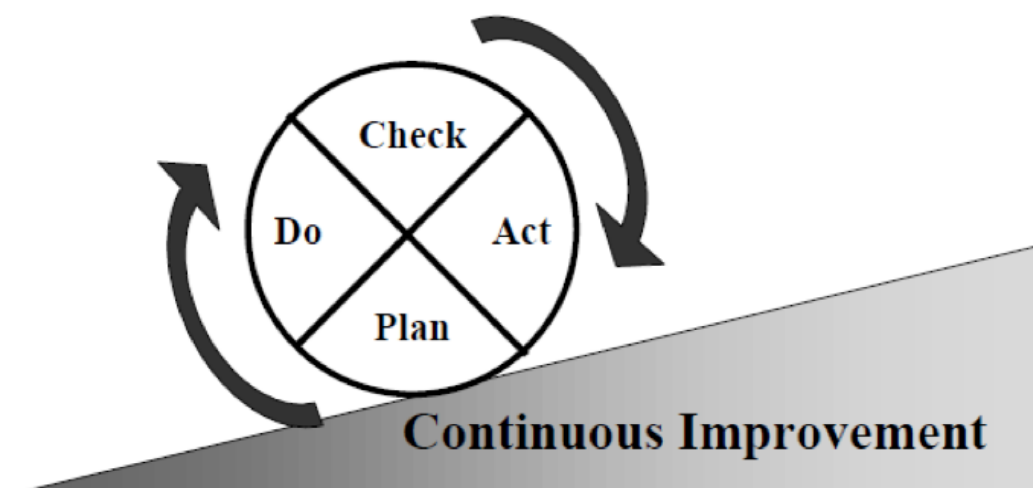

Figure 3.4: Illustration of Plan Do Check Act (PDCA) cycle

Each part of the cycle is explained below.

- Plan: identify problems or opportunities for improvement and develop a plan to make changes;
- Do: implement the plan, documenting any changes made;
- Check: analyse the revised process to see if goals have been achieved;
- Act: standardise, document and divulge the results. In the case of not achieving the goals, determine why not and proceed accordingly.

When continuous improvement is in place, the PDCA cycle is repeated over and over again, as is illustrated in Figure 3.4. This cycle may bring improvement in any of the various quality dimensions: performance, features, reliability, conformance, durability, serviceability, aesthetics and perceived quality.

3.3.1 Reengineering Business Processes for BIM

BIM is about process change, about working differently. BIM supports the development of tasks in such a way that these can be easily coordinated, recorded and verified. The information produced by one stakeholder can be reutilised by others. Therefore, BIM supports the elimination of the process waste which occurs due to duplication of information; in traditional 2D environments information is produced and represented a number of times by different stakeholders which leads to errors and omissions in design documentation.

BIM can also be deemed as a new methodology for managing the lifecycle of a building with a focus on environmental impact, building design and documentation. The implementation process could impose on newly started or ongoing infrastructure projects some delays through; potential disruptions, difficulties in workflow transition (Kirby, 2007) and in many of these circumstances, a lack of appropriate training to staff was evident. Furthermore, it is vital to derive strategies that adversely affect the existing business practices of companies who adhere BIM technologies within their organisations.

The following steps are adapted from the continuous improvement cycle in 3.4 to provide for organisations to minimise to assist organisations in minimising these barriers during the design and construction process of a project. Most of the steps are detailed in table 3.1 within the phases of the BIM implementation process that include preparation, roll-out and post-implementation.

i) Preparation phase (Plan): In this phase the organization needs to prepare for this new investment by analysing its effect on the business process and preparing methods of minimizing any difficult situations during, and after, the implementation (e.g. ongoing project work and activities shouldn't be affected in a negative way such as budgetary restrictions and delays due to BIM training, from the BIM adoption. Utilization of a BPM (Business Process Management) system, implementation checklists, and initial training can alleviate many of the problematic situations. Recognition of the business processes, which require re-engineering, is identified.

ii) Role-out phase (Do): In this phase, the organization works through the change management process for the implementation of all the systems, training programmes and the conducting of business assessments of the outcomes achieved via the newly implemented system on live pilot projects. This involves a complete assessment of the reengineered business processes within the business. Unfortunately, advice on these matters may not necessarily be received from BIM system services' suppliers. It is important to measure the effectiveness, efficiency and performance of all the business processes through the pilot projects and rectify any issues identified before moving to post-implementation.

iii) Post-implementation phase (Check and Act): In this phase, a thorough analysis is conducted of the effectiveness on business intelligence accrual and extended performance gain, through the new implementation, in the completed pilot projects. This will lead to defining organizations' current status and future plans; in particular, new business opportunities that the business could target (Kirby, 2007), the extended training requirements of staff, and, more importantly, the completion of the assessment of ROI (Return on Investment) following the organizations' acceptance of BIM within their business strategy.

Table 3.1 below highlights the key steps in the phases.



**American online
LIGS University**
is currently enrolling in the
Interactive Online **BBA, MBA, MSc,**
DBA and PhD programs:

- ▶ enroll **by September 30th, 2014** and
- ▶ **save up to 16%** on the tuition!
- ▶ pay in 10 installments / 2 years
- ▶ Interactive **Online education**
- ▶ visit www.ligsuniversity.com to
find out more!

Note: LIGS University is not accredited by any nationally recognized accrediting agency listed by the US Secretary of Education. More info [here](#).



Phase	Steps involve	Focus point
Preparing	a) Planning for the change	
	b) Business process management	Effects on the Business Process (BP)
	c) Implementation checklist	
	d) Implementation plan	Minimizing the recognized effects on the BP
	e) Initial training	In particular higher management and those who are affected the most
	f) Training plan for next phase	
Rolling-out	g) Change management	
	h) Adequate hardware and software	
	i) Implementation	
	j) Training all staff	
	k) Piloting first few projects	Performance of the BP
	l) Minor adjustments	Rectifying the BP
Post-implementation	m) Update implementation plan	
	n) Post-implementation checklist	Any future activities and plan
	o) Assess adequacy of training	
	p) Evaluate pilots for further recommendation	
	q) Confirm increased business intelligence and performance	Optimizing the BP

Table 3.1: Process Reengineering for BIM Adoption & Focal Points (Arayici and Aouad, 2010)

3.3.2 Challenges in the Business Process

Within the non-BIM environment, current industry and business practices do not facilitate the efficient transfer of requirements, design and as-built construction, data, information and knowledge for the increasingly critical phases of environmental impact assessment, infrastructure operations, and strategic asset and facility management.

Nevertheless, the utilisation of BIM systems requires dramatic changes in current business practices which will lead to the development of new and sustainable business process models. Due to cultural and other aspects within many countries, acceptance of BIM has been a challenge which requires overcoming many barriers and steep learning curves that ultimately forces a paradigm shift. Having said that, as a remedy to previously mentioned inefficiencies, BIM is said to be a serious contender. A point of view which describes the advantages of BIM in a concise manner is given below.

BIM is a process of representation to create and maintain multidimensional, data-rich views throughout a project lifecycle to support communication (sharing data), collaboration (acting on shared data), simulation (using data for prediction), and optimisation (using feedback to improve design, documentation and delivery) (Laiserin, 2007). There are areas where process improvement can be realised by BIM within the building lifecycle, such as improved accuracy, consistency, integration, coordination and synchronisation. These areas of improvement are detailed in table 3.2.

Targets	Potential Improvement	Example case
Accuracy	Complete, correct communication between AEC/O project participants	Owner requirements to designer (programme/ brief), designer feedback to owner (visualization/simulation), design intent to construction documents, (CDs), and CDs to constructors/ bidders
Consistency	Uniformity within a representation	Within a set of drawings or specifications
Integration	Linkage between related representations	Between drawings and specifications or between models and sequencing/schedules
Coordination	Interference checking among disciplines	Between building and site or between structural and Mechanical/ Electrical/Plumbing (MEP)
Synchronization	Achieving comparable levels of detail/ resolution over time	Drawings/specifications versus cost

Table 3.2: Potential Areas of Business Process Improvements (Mihindu and Arayici, 2009)

3.3.3 Solving the skill and knowledge gap

On the other hand, it is anticipated that BIM will bring about new challenges for construction stakeholders such as the emerging knowledge and skill gap in BIM implementation and use. BIM causes organisations to employ more experienced project managers and project architects at the very beginning of an infrastructure development project; in particular, those with good construction and design knowledge and having the capability for building models are required at early stages.

BIM systems require architects and designers to spend more time on the design and less time on drafting (Birx, 2006). Also, the features offered by these systems facilitate the production of more thorough designs and more comprehensive documentation with less overall time.

New graduates can now move swiftly into design studies so that they become better designers in a shorter duration, with less experience in drafting which is no longer a major requirement for modelling with these systems. Therefore, curricula, educational programmes and courses targeting this career pathway need to be developed for new graduates who will be more attractive to the organisations that employ BIM systems for their construction works. This new career path may also lead to the offering of better salaries for younger graduates and hence more interest in such programmes can easily be generated. Furthermore, new job opportunities such as BIM Managers are becoming a reality (Gallelo, 2008).

3.3.4 Building Information Modelling Process

The concept of BIM is to develop a model through a project's stages using building components that contain information. Figure 3.5 shows the concept of process modelling, whereby the model moves through various stages. The naming of these model processes are defined by PAS 1192-2:2013 which specifies the requirements for achieving building information modelling level 2 in construction projects.

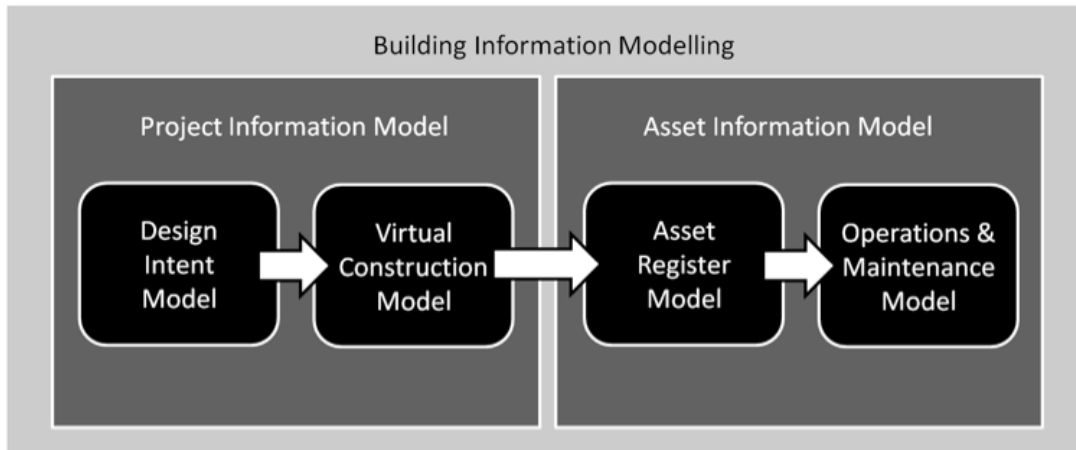



Figure 3.5: The BIM Process

.....Alcatel-Lucent 

www.alcatel-lucent.com/careers

What if you could build your future and create the future?

One generation's transformation is the next's status quo. In the near future, people may soon think it's strange that devices ever had to be "plugged in." To obtain that status, there needs to be "The Shift".



In addition, figure 3.6 below shows how the modelling process will change over the project stages in regards to model data. During the early conceptual design, the project is communicated by showing spaces, shapes and generic components but then, as the project moves into detailed design, information about the components in the model will increase to allow all types of engineering analysis to be undertaken to support the design (Teicholz, 2013). These two stages will form the *Design Intent Model*.

As information becomes available from contractors, sub-contractors and manufacturers, these components' level of detail are increased further to help cost estimating, procurement, constructability and installation, known as the *Virtual Construction Model*. This then forms the as-built information, known as the *Asset Register Model* for facility managers to then use as an Operations and Maintenance Model. Therefore non-graphical information starts to override graphical information to allow this information to be entered into an FM system (Teicholz, 2013). This concept will further elaborated in the next section.

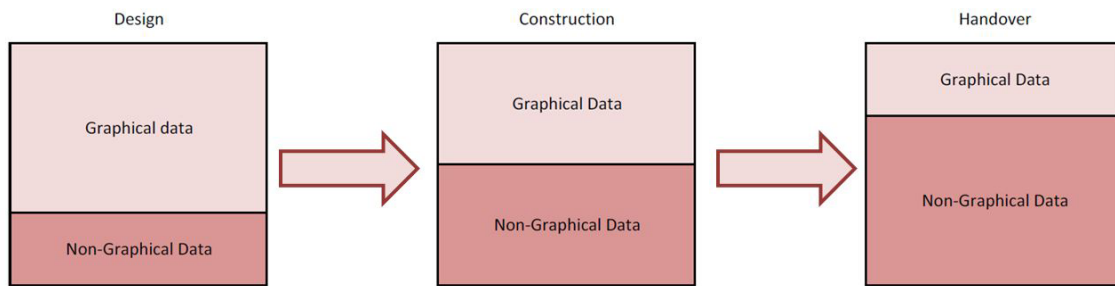

Figure 3.6: The BIM model processing (Teicholz, 2013)

3.3.4.1 Integrated Delivery Manual as a Standard for BIM Process Modelling

Working efficiently requires all participants in an organisation to know which, and when, different kinds of information have to be communicated (Karlshoj, 2011). Hence, Integrated Delivery Manual, as a buildingSMART standard for processes, is introduced to specify the information of certain types needed during the building lifecycle. It offers a common understanding for all parties about when and what exchange of information is needed (BuildingSMART, 2013).

The Manual is, therefore, a methodology for capturing business processes and developing specifications in projects on detailed user information exchange requirements and it can provide significant help in achieving the full benefit from Building Information Model (BIM). If the information required is available when needed and the quality of the information is satisfactory, then design and construction processes will be greatly improved. For this to happen, there should be a common understanding of the building processes and of the information that is needed for, and the results from, their execution.

The Manual sets out a methodology and format for the provision of an integrated reference for the processes and data required by a BIM. It describes how to identify and describe the processes undertaken within construction, and the information required for their execution and the results. It also describes how this information can be further detailed to support solutions provided by the building information system providers in a form that enables its reuse, and how it can be configured to meet national, local and project needs.

It explains the methodology for the interoperability specification development to streamline the business processes with the information specification required by this flow, defines a form in which the information should be specified, and specifies an appropriate way to map and describe the information processes within a construction lifecycle.

It aims to facilitate interoperability between BIM applications used in the design and construction process, to promote digital collaboration between actors in the process and to provide a basis for accurate, reliable, repeatable and high-quality information exchange. As shown in figure 3.7, it consists of 3 layers (i) Process maps, (ii) Exchange requirements, and (iii) functional parts and business rules, and, as whole, it reflects the strategy framework for the development of the interoperability specification for BIM process modelling.

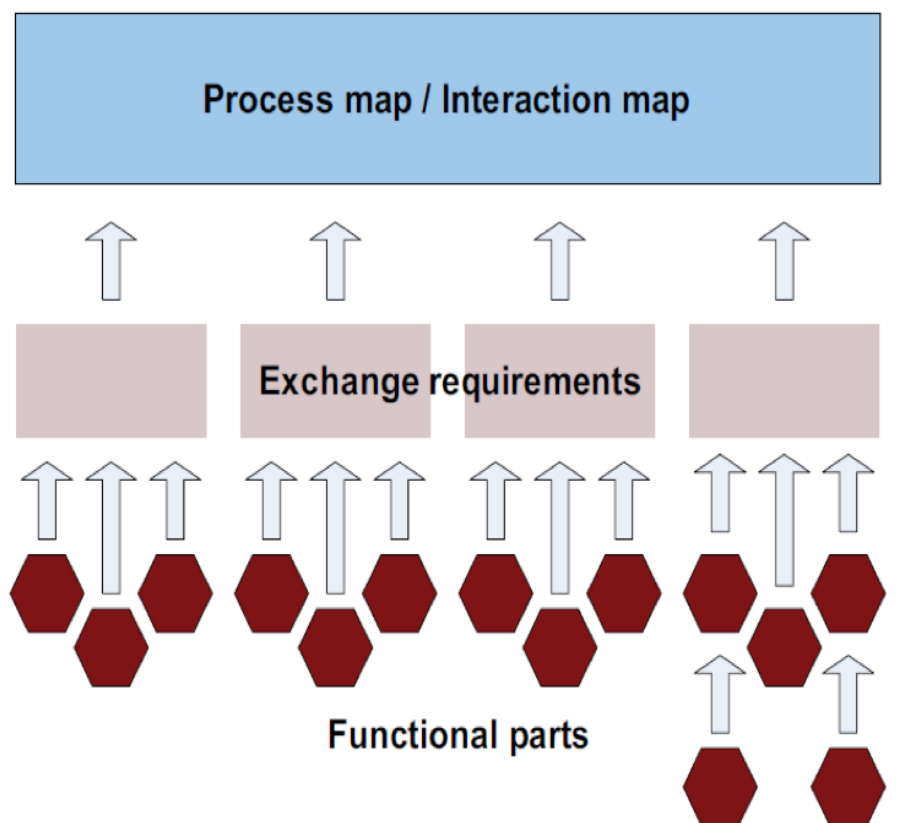

Figure 3.7: Process development framework for interoperability (BuildingSMART 2010)

The organization of the components within the framework is based on two ideas:

- a) The components in the top layer of the framework relate to processes; they progress through data specifications in the middle layers and include application software elements in the bottom layer;
- b) Similarly, the components relating to industry practitioners are in the top layer of the framework and to ICT analysts and programmers in the bottom layers. In the development of the process and interoperability specifications, IDM helps to achieve the following objectives:
 - To describe the need for information exchange between processes.
 - To specify how to capture the information for exchange between these processes.
 - To identify the actors sending and receiving information.
 - To define, specify and describe the information for exchange to satisfy the requirements at each point of the business process.
 - To ensure that definitions, specifications and descriptions are provided in a form that is useful and easily understood.
 - To create detailed specifications of the information captured within the exchange requirements to facilitate the development of software building information systems.
 - To ensure that the information specifications can be made relevant to local working practices.

Join the best at the Maastricht University School of Business and Economics!

Top master's programmes

- 33rd place Financial Times worldwide ranking: MSc International Business
- 1st place: MSc International Business
- 1st place: MSc Financial Economics
- 2nd place: MSc Management of Learning
- 2nd place: MSc Economics
- 2nd place: MSc Econometrics and Operations Research
- 2nd place: MSc Global Supply Chain Management and Change

Sources: Keuzegids Master ranking 2013; Elsevier 'Beste Studies' ranking 2012; Financial Times Global Masters in Management ranking 2012

Maastricht University is the best specialist university in the Netherlands (Elsevier)

Visit us and find out why we are the best!
Master's Open Day: 22 February 2014

www.mastersopenday.nl



However, in order to make an information delivery manual operational, it is necessary to support it with technologies, that is to say, the data being communicated should be interpreted by tools as it can become an interoperability issue when information is exchanged (Karlshoj, 2011). Figure 3.8 shows the three BuildingSMART interoperability solutions as an integral process. These are IFC (Industry Foundation Classes) as the common data exchange standards, IDM (Integrated Delivery Manual) as the integrated process modelling standards, and IFD (international Framework of Dictionary) as the common language and the terms and coding of building objects.

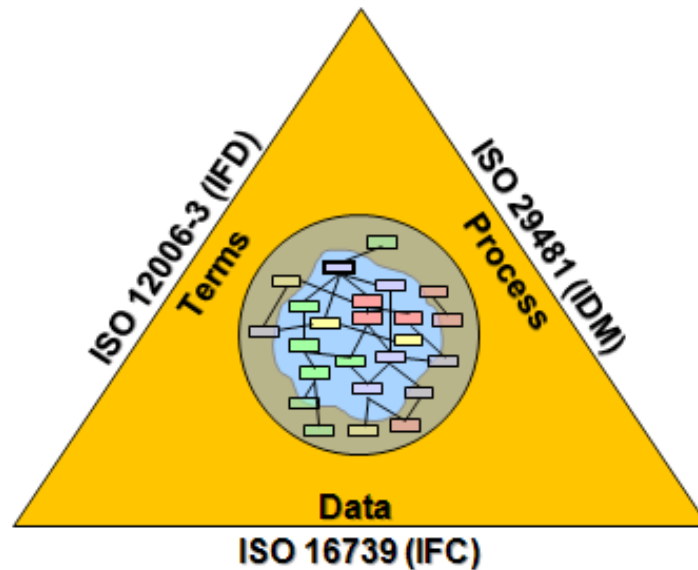

Figure 3.8: Interoperability solutions (BuildingSMART, 2013)

The continuing development and support of solutions such as IFC, IFD and IDM and their implementation on BIM projects can help in reducing the cost of interoperability, in streamlining the handover of information at each stage of the facilities' lifecycle and in supporting the view shown in figure 3.9 that addresses the fragmented approach previously mentioned.

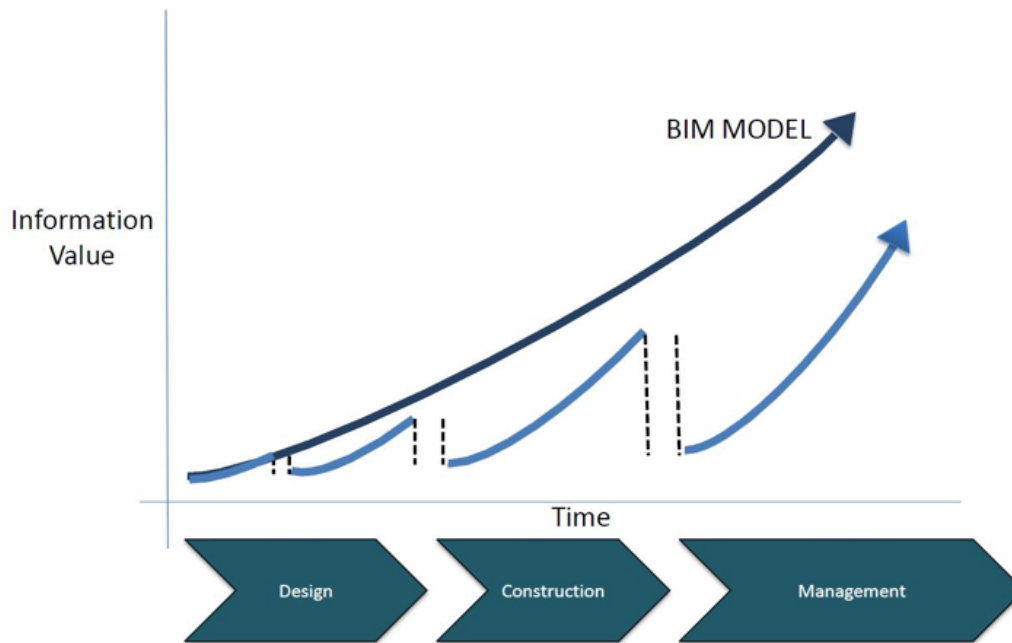

Figure 3.9: Streamlining information (Excitech, 2011)

Greater interoperability will be supported through the use of COBie, IFC, IDM and IFD and these open standards are being developed to reduce the cost and improve the quality of the information handover (NIST, 2007).

3.3.4.2 Exemplary BIM Process Modelling with IDM for FM

Interoperability between systems should be the main focus in setting up early collaboration. Both the AEC and FM industries use powerful applications but they are not fully automated in their processes even though early collaboration between parties can assist in understanding each other's requirements, which is vital for BIM integration with FM.

FM needs a combination of graphical and non-graphical information for its processes. Therefore, the development of an IDM based process map and IFD catalogue through the use of structured COBie data within BIM models that are exchanged via IFC are demonstrated below. Information structured through a common language defined in IFD can be used in a middleware application such as EcoDomus that helps bridge the gap between BIM and FM.

Figure 3.10 shows a process map in which the first stage is to respond to the Employer Information Requirements (EIR) in the form of a project BEP (BIM Execution Plan) with input from the AEC and FM parties to understand each other's requirements.

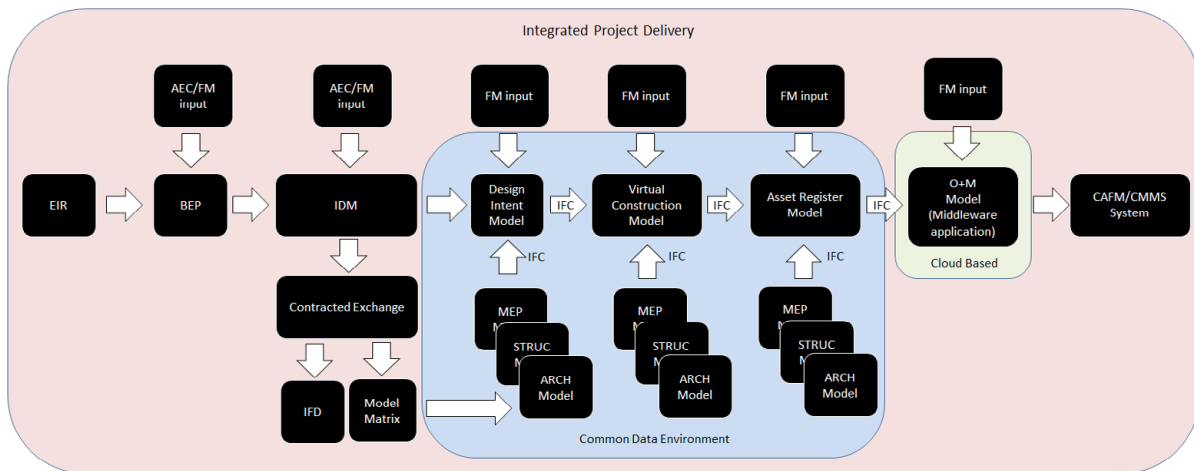
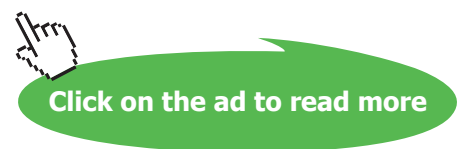

Figure 3.10: Process map

An IDM will be then be developed based on the information that derives from the BEP, and will detail an agreed IFD catalogue to structure information and will also define a model elements’ responsibilities’ matrix. These will form the contracted exchange of information between the parties to ensure all the parties are aware of their roles and responsibilities in the process, as shown in figure 3.11.



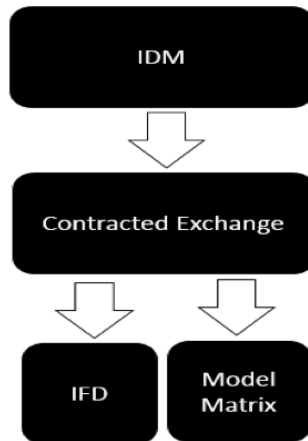

Figure 3.11: IDM content

The IFD will define an agreed naming convention of information to establish a common language that both AEC and FM industry systems can read. This will consist of a series of naming conventions for objects, spaces and equipment that will support asset naming for the use of RFID tags as shown in figure 3.12.

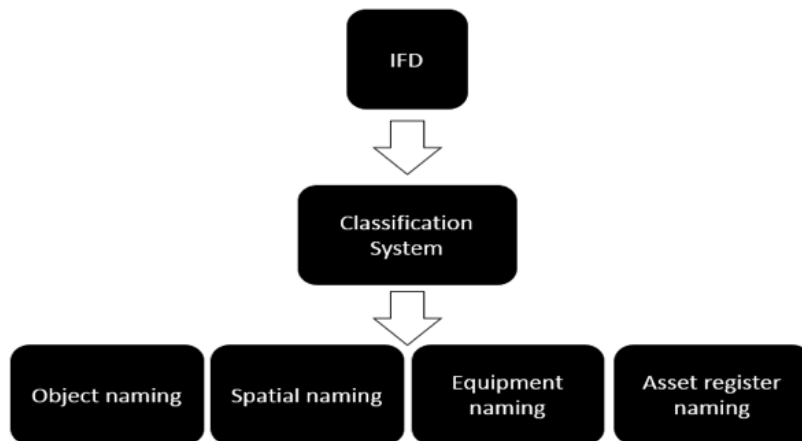

Figure 3.12: IFD Content

Agreeing to a common naming convention will structure information within models and allow users to identify and re-use this information for their related tasks, whether it is for cost estimating, logistics planning, procurement or even facilities management. The structuring of this information is shown in figure 3.13.

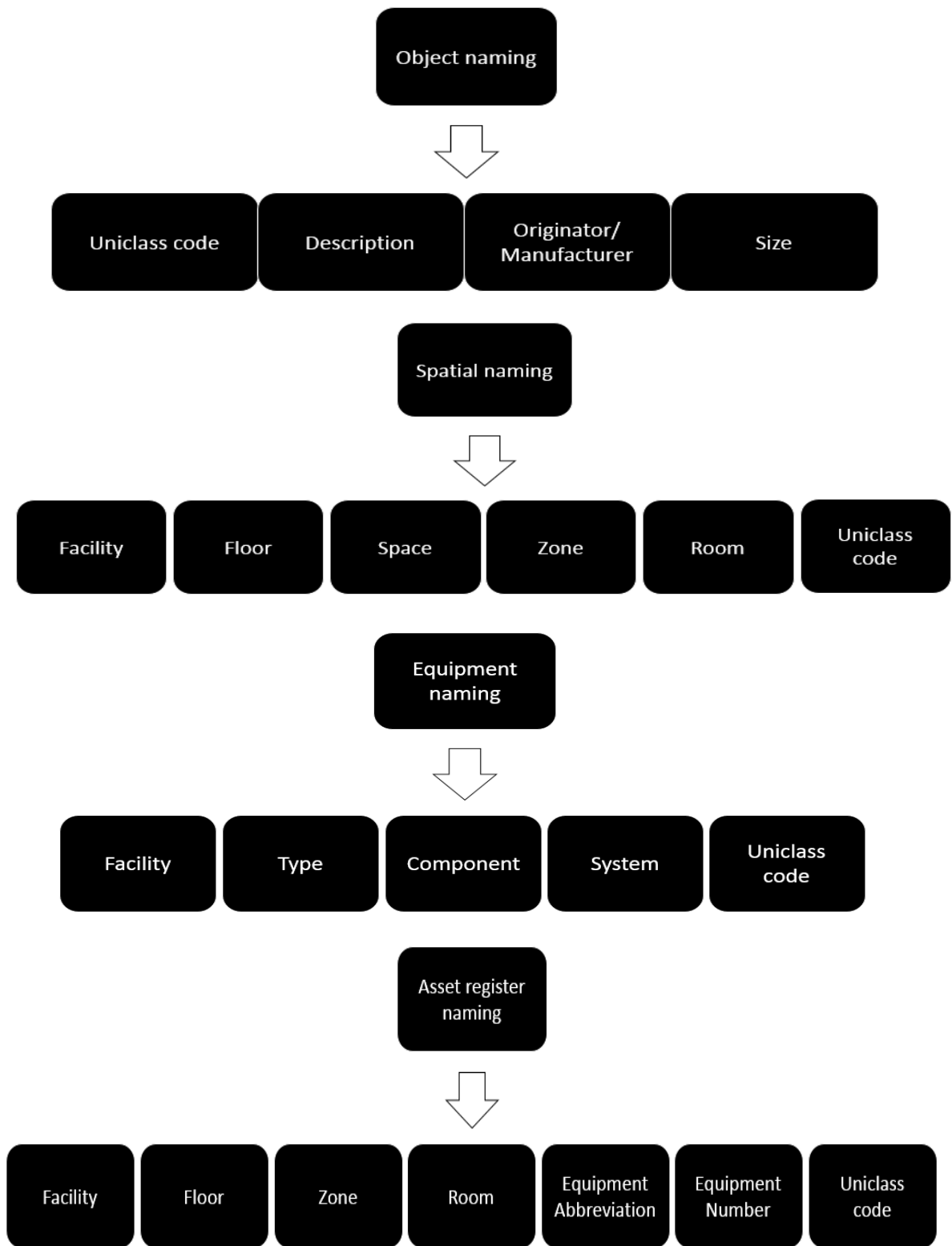

Figure 3.13: Naming conventions

Once this common language has been defined, it then leads to the production of a model elements' responsibilities' matrix for model components, spaces and equipment and their associated information. The model element responsibilities' matrix, as shown in figure 3.14, will clearly define:

- The model element authors (MEA)
- The model element's level of detail (LOD)
- Key information on the handover stages
- The required file format for information exchange

This document will clearly define when information needs to be exchanged in an agreed format that will support the recipient and their related systems. It supports the ownership of the data and allows information to be tracked through the various project stages.



Empowering People. Improving Business.

BI Norwegian Business School is one of Europe's largest business schools welcoming more than 20,000 students. Our programmes provide a stimulating and multi-cultural learning environment with an international outlook ultimately providing students with professional skills to meet the increasing needs of businesses.

BI offers four different two-year, full-time Master of Science (MSc) programmes that are taught entirely in English and have been designed to provide professional skills to meet the increasing need of businesses. The MSc programmes provide a stimulating and multi-cultural learning environment to give you the best platform to launch into your career.

- MSc in Business
- MSc in Financial Economics
- MSc in Strategic Marketing Management
- MSc in Leadership and Organisational Psychology

BI NORWEGIAN BUSINESS SCHOOL

EFMD **EQUIS** ACCREDITED

www.bi.edu/master



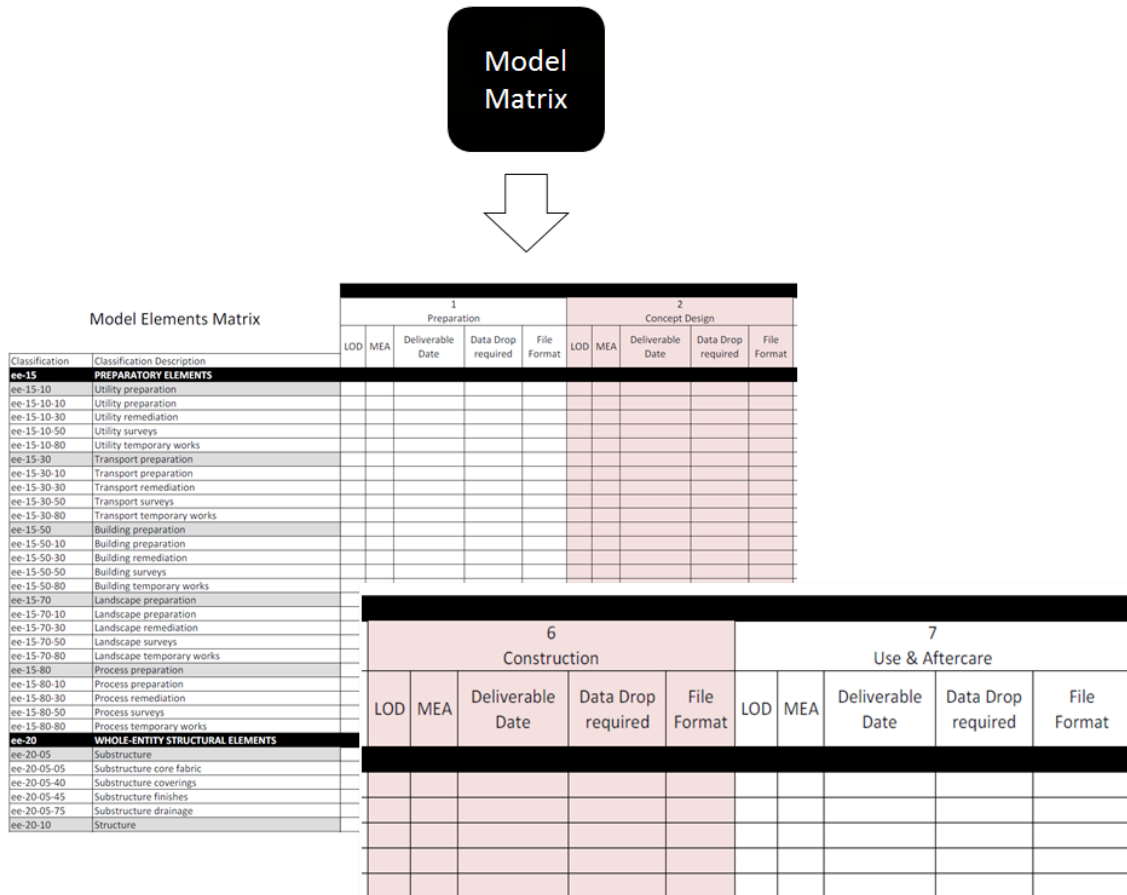

Figure 3.14: The model elements' responsibilities' matrix

Once modelling is to begin, information is held within a CDE that allows access to all the parties contributing in the process. Therefore, information is controlled at all times and kept within a single environment. The process of exchanging models and their associated information will be through the use of IFC models containing COBie information. Models will be federated within the common data environment where further COBie information is populated by all parties. This workflow is shown in figure 3.15.

Process of mapping COBie data from various data rich discipline models via IFC exports into a federated environment via a middleware application

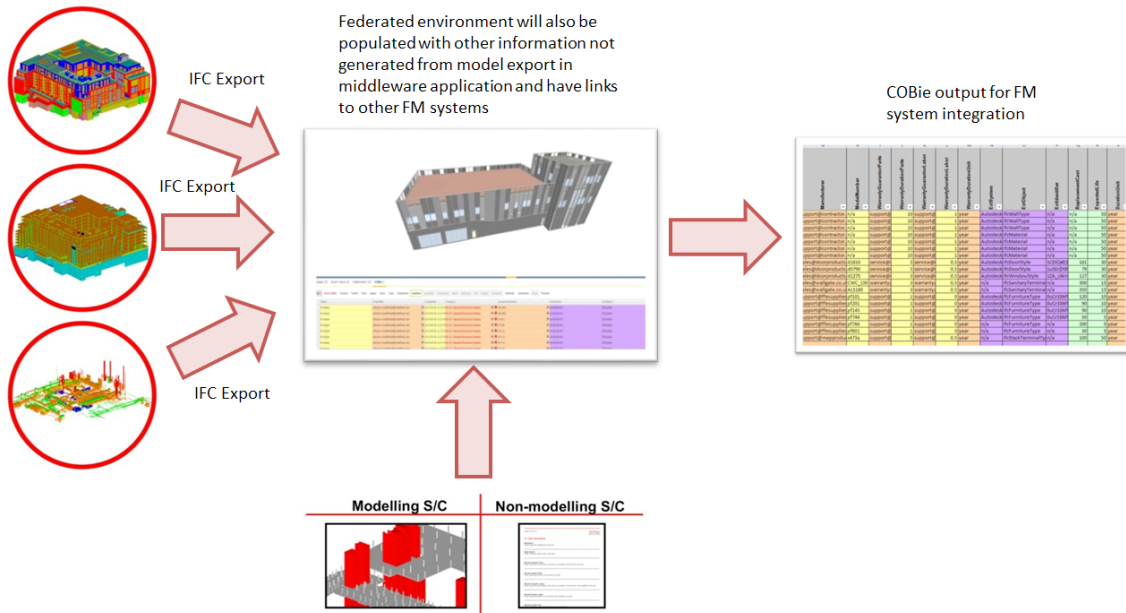

Figure 3.15: COBie workflow

When the information is ready to handover to FM, the federated model is linked through a proprietary application (such as EcoDomus) which will link the model and its associated information to the FM’s CAFM/CMMS and provide a two-way link between systems, as shown in figure 3.16. As a result, FM will have access to both graphical and non-graphical information before they carry out their everyday processes to enter into their FM systems to support full lifecycle analysis.

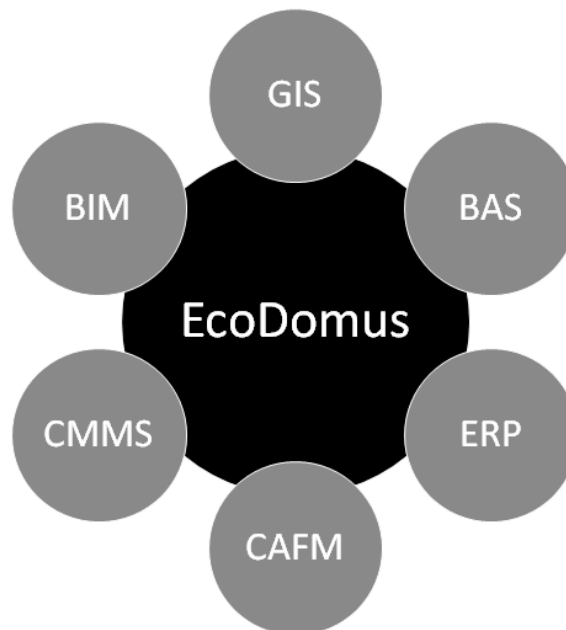

Figure 3.16: EcoDomus link (adapted from Teicholz, 2013)

This process should be procured under an IPD agreement meaning that all parties are contractually engaged from the very start and they can all provide valuable input into the total process. Sharing the risk and reward should break down the silo mentality and ensure that everyone is aware of how their decisions affect each other and thus work towards the common goal of accurate, structured and complete information through a streamlined process approach by stakeholders, particularly the facility managers and building owners.

3.4 Summary

Current practice and the way in which construction companies are structured generate bottlenecks for process improvement in terms of quality, cost and time efficiencies. A paradigm shift is needed for rethinking construction processes as advised in the Egan report. BIM is not only about technological advancement, it is actually more about process improvement too. Therefore, BIM as a way of utilising a new working methodology entails process reengineering. Continuous process improvement is critical for lean design and construction processes and it has a cycle with 4 phases (Plan, Do Check and Act). This continuous improvement can be contextualised for BIM implementation as the preparation, roll-out and post-implementation phases. There are some industry standards and research outputs prescribing BIM enabled building lifecycle processes such as Senate Properties from Finland, GSA processes and the Process Protocol approach from the UK (which is a research project output from Salford University). It is more meaningful when the process stages are linked with BIM activities throughout the lifecycle from site BIM to environmentally integrated BIM.

Need help with your dissertation?

Get in-depth feedback & advice from experts in your topic area. Find out what you can do to improve the quality of your dissertation!

Get Help Now



Go to www.helpmyassignment.co.uk for more info



Helpmyassignment



Accuracy, integration, synchronisation, consistency and coordination are key targets to consider for process modelling and improvement in the building lifecycle processes. BIM is also about people too. Professionals involved in the processes should be educated and well trained in order to conduct their BIM functions within the process appropriately. IDM (Integrated Delivery Manual) is the methodology for such process modelling and interoperability specification development within the BIM integrated building lifecycle processes.

3.5 References

Arayici, Y. and Aouad, G. (2010), '[Building information modelling \(BIM\) for construction lifecycle management](#)', in: *Construction and Building: Design, Materials, and Techniques*, Nova Science Publishers, NY, USA, pp. 99–118.

Autodesk (2003), Building Information Modelling in Practice: White Paper, Retrieved from <http://www.ddscad.com/>

Birx, G.W. (2006), "How Building Information Modelling Changes Architecture Practice: Best Practice", AIA-P016609, BP 13.01.03, 10/06.

BuildingSMART, (2010), "Information Delivery Manual, Guide to Components and Development Methods, http://iug.buildingsmart.org/idms/development/IDMC_004_1_2.pdf

Building SMART, (2013), Industry Foundation Classes (IFC) data model, Retrieved 6 October, 2013, from <http://www.buildingsmart.org/standards/ifc>

CIC (Construction Project Information Committee), (2013), Post Contract-Award Building Information Modelling (BIM) Execution Plan (BEP). Retrieved from http://www.cpic.org.uk/wp-content/uploads/2013/06/cpix_post_contract_bim_execution_plan_bep_r1.0.pdf

Egan, (1998), Rethinking Construction – The Egan Report, Construction Task Force, http://constructingexcellence.org.uk/wp-content/uploads/2014/10/rethinking_construction_report.pdf

Excitech, (2011), From Building Information Management to Facilities Management, Retrieved 4 August, 2013, from <http://www.excitech.co.uk/resources/white-papers.asp>

Gallelo, D. (2008), "The New 'Must Have' – The BIM Manager", AECbytes Viewpoint No: 34, http://www.aecbytes.com/viewpoint/2008/issue_34.html [accessed: 21/04/08].

Karlshoj, J. (2011), [Information Delivery Manuals](#). Retrieved 22 October 2013, from <http://iug.buildingsmart.org/idms>

Kirby, L. (2007), "BIM Transition in a Small Firm: Best Practices", AIA-P016368 – BP.

Mihindu, S. and Arayici, Y. (2009), "Digital Construction through BIM Systems will Drive the Re-engineering of Construction Business Practices", International Conference Visualisation, IEEE Computer Society, CA, ISBN 978-0-7695-3271-4, P29–34.

NIST (National Institute of Standards and Technology), (2007), "General Buildings Information Handover Guide: Principles, Methodology and Case Studies", An Industry Sector Guide of the Information Handover Guide Series (NISTIR 7417), US Department of Commerce.

Teicholz, P. (2013), BIM for Facility Managers, Hoboken, New Jersey: John Wiley & Sons, Inc.



Brain power

By 2020, wind could provide one-tenth of our planet's electricity needs. Already today, SKF's innovative know-how is crucial to running a large proportion of the world's wind turbines.

Up to 25 % of the generating costs relate to maintenance. These can be reduced dramatically thanks to our systems for on-line condition monitoring and automatic lubrication. We help make it more economical to create cleaner, cheaper energy out of thin air.

By sharing our experience, expertise, and creativity, industries can boost performance beyond expectations. Therefore we need the best employees who can meet this challenge!

The Power of Knowledge Engineering

Plug into The Power of Knowledge Engineering.
Visit us at www.skf.com/knowledge

SKF

Download free eBooks at bookboon.com



Click on the ad to read more

4 BIM Technologies in the Process

4.1 Introduction

BIM applications expand over the building lifecycle. A designer uses BIM for design, for developing and analysing a project, a client utilises BIM to gain a full understanding of project needs, and a contractor uses BIM to manage the construction project; finally, facility managers can use BIM applications throughout the operation and decommissioning stages (Bryde et al., 2013). Furthermore, BIM applications can help construction players improve communication, reduce errors and, potentially, save money and time (Latiffi et al., 2013) throughout the building lifecycle.

Because such benefits are possible to reap throughout the lifecycle as implied in the graph in figure 3.1, continuity, efficiency, effectiveness and quality are the key buzzwords that are integrated within sustainable building lifecycle management in order to reflect the mutual link between BIM and sustainability; more specifically sustainable design and construction and sustainable FM and building maintenance.

Sustainability as a theme has become very topical in construction in relation to building performance optimisation and minimising the lifecycle cost (Sistani, 2013). Because BIM enables the encapsulation of multi-disciplinary information in one model, it provides an opportunity for considering sustainability measures and performance analyses during the design process (Azhar & Brown, 2009; Krygiel & Nies, 2008). For instance, architects can analyse a building form and mass for optimisation of the envelope and balance glazing ratios; subcontractors can use BIM technology to reduce waste and combine shipments to further reduce carbon footprints while contractors can carry out analysis on site conditions (including wetlands and protected habitats) and can use the site model to coordinate logistics better to eliminate potential issues, and engineers can use BIM modelling to reduce energy demands through energy modelling (Hardin, 2009).

Currently, BIM has many analysis software programmes but Virtual Environment (VE), Autodesk Green Building Studio (GBS) and Ecotect are the most commonly used in the market (Wong & Fan, 2013). A BIM model can be linked to analysis tools to assist in designing energy-efficient buildings during the early design phase (Moakher & Pimplikar, 2012). This analysis includes internal analysis (such as the optimization of a building's HVAC systems) as well as contextual analyses such as site orientation, daylighting and building massing (Azhar & Brown, 2009).

The information encapsulated in a BIM model will become richer and richer throughout the downstream of the lifecycle process. This level of information encapsulated in the BIM model is classified into LOD (Level of Development) categories, which are explained below in section 2, while the content of this chapter will be further expanded and articulated in chapter 5 on Sustainable Design and BIM, in chapter 6 on BIM for Construction Management and in chapter 7 on BIM for Facilities Management.

4.2 Level of development (LOD)

The level of development for each model component was introduced by AIA (the American Institute of Architects) Documents E202 in 2008 (Thomassen, 2011). The level of development is defined as the level of completeness to an extent, which a BIM model is developed (Velasco, 2013). More precisely, the LOD describes the steps through which a BIM model can logically progress from the lowest level of conceptual approximation to the highest level of representational precision (Brewer et al., 2012).

Five levels of development are defined by AIA to indicate the extent to which a BIM model is developed. These are shown in table 4.1 as LOD 100, LOD 200, LOD 300, LOD 400 and LOD 500. These codes correspond to project stages such as the Conceptual stage and the approximate geometry, precise geometry, fabrication and as-built stages (Jaing, 2011; Velasco, 2013). These levels require coordination amongst all stakeholders involved in a project to identify who will be responsible for the development of each component and to what extent the BIM model will be detailed (Gaudin, 2013). The content of each level are described as follows (Brewer et al., 2012):

- LOD 100 Conceptual: The model will consist of overall building massing including orientation, volume, height, location and area
- LOD 200 Approximate geometry: generalized systems or assemblies with approximate size, shape, location, orientation and quantities
- LOD 300 Precise geometry: specific assemblies accurate in terms of size, location, orientation, shape and quantities
- LOD 400 Fabrication: specific assemblies accurate in terms of size, location, shape, orientation and quantities with complete fabrication
- LOD 500 As-built: constructed assemblies that are accurate and actual in terms of shape, location, size, orientation and quantities.

LOD	Model Content Requirements	Authorised Uses	
LOD 100	Overall building massing indicative of area, height, volume, location and orientation is modelled in 3D dimensions	Analysis	The model is analysed based on volume, area and orientation by application of generalised performance criteria assigned to the representative BIM model
		Cost Estimating	The model is used to develop a cost estimate based on current area, volume or similar estimating techniques
		Schedule	The model is used for project phasing and construction
LOD 200	Model elements are modelled as generalised systems or assemblies with approximate quantities, size, shape, location and orientation. Non-geometric information can also be attached to the BIM model	Analysis	The model is analysed for performance of selected systems by application of generalised performance criteria assigned to the representative BIM model
		Cost Estimating	The model is used to develop a cost estimate based on approximate data provided and conceptual estimating techniques
		Schedule	The model is used to show ordered, time scaled appearance of major elements and systems
LOD 300	Model elements are modelled as specific assemblies accurate in terms of quantity, size, shape, location and orientation. Non geometric information is also attached to the BIM model	Analysis	The model is analysed for the performance of selected systems by application of specific performance criteria assigned to the representative BIM model
		Cost Estimating	The model is used to develop a cost estimate based on specific data provided and conceptual estimating techniques
		Schedule	The model is used to show an ordered, time scaled appearance of detailed elements and systems
		Construction	Suitable for the generation of traditional construction documents and shop drawings
LOD 400	BIM model components are modelled as specific assemblies accurate in terms of quantity, size, shape, location and orientation with complete fabrication, assembly and detailing information. Non-geometric information is also attached to the BIM model.	Analysis	The model is analysed for performance of approved systems based on specific BIM model
		Cost Estimating	Costs are based on the actual cost of specific elements at buyout
		Schedule	The model is used to show an ordered, time scaled appearance of detailed specific elements and systems including construction means and methods
		Construction	BIM model is the virtual representation of the proposed element and are suitable for construction.
LOD 500	BIM Model is modelled as constructed assemblies, actual and accurate in terms of size, shape, location, quantity and orientation. Non-geometric information may also be attached to the modelled elements	General Usage	The model is utilised for maintaining, altering and adding to a project but only to the extent that is consistent with any licences granted in the agreement or in a separate licensing agreement

Table 4.1 Levels of Development, (Gaudin, 2013)

4.3 BIM Tools In The Process

BIM authoring tools denotes BIM capable design tools and there are numerous BIM authoring tools and supporting software made available in the AEC industry by several software vendors. BIM tools can be classified as: Preliminary Tools (Preliminary Space Planning Tools, Preliminary Massing and Sketching Tools, Preliminary Environmental Analysis Tools, Preliminary Cost Estimation Tools), BIM Design Tools, Structural Design Tools, BIM Construction Tools, Fabrication Tools, Environmental Analysis Tools, Construction Management Tools, Cost Estimation Tools, Specification Tools, Facility Management Tools and Mechanical Tools (AEC integration lab., 2008; Çetiner, 2010). Knowing that BIM implementation requires suitable tools, it is, therefore, important to choose the right tools, especially for small scale firms which may not have the same financial flexibility as large scale firms. While in chapter 3, a long list of BIM tools is presented, table 4.2 below maps out BIM tools into project lifecycle stages.



"I studied English for 16 years but...
...I finally learned to speak it in just six lessons"

Jane, Chinese architect

ENGLISH OUT THERE

Click to hear me talking before and after my unique course download



	Feasibility	Conceptual Design	Detail Design	Procurement	Manufacturing	Construction & Installation	Handover & Commissioning	Operations & Maintenance
Utility Software	MS Office							
Conceptual Modelling	Google Earth							
	Rhino, Inventor, 3DS Max, Form-Z							
Space Planning	Trelligence: Affinity							
Form Finding	Bentley: Generative Components							
Parametric Estimating	Beck: dProfiler							
BIM Authoring Architecture Design	Revit Architecture, Bentley: Architecture, Graphisoft: Archicad							
BIM Authoring Architecture CAD/CAM	Gehry: Digital Project							
BIM Authoring Structural Design	Revit Structures, Design Data: SDS/2 Bentley: Structural Modeller							
BIM Authoring Structural CAD/CAM	Tekla: Tekla Structures. AceCad: StruCad							
BIM Authoring MEP Design	Autodesk: Revit MEP Bentley: Building Electrical, Building Mechanical Systems							
BIM Checking	Solibri: Model Checker							
BIM Take Off	Innovaya: Composer							
BIM Estimating	Vico:VirtualConstruction							
MEP CAD/CAM	MAP: CAD-Duct, CADPIPE, Hevacomp							
Building Performance Analysis	Oasys: GSA, STAAD, RAM, GTStrudi							
	Ecotect, IES: VE-Ware, SAP, Energy Plus							
Computer Aided Drawing	Bentley: Triforma							
	Autodesk: Architectural Desktop (ADT)							
	Autodesk: Building Services Desktop (BSD)							
Design Checking	Autodesk: Navisworks							
Cost Control	Sage, COINS, Summit, Conquest, Redsky							
Construction Planning	Primavera: P3, MS Project, Synchro							
Facilities Management	Architbus, Planet FM, TF Facility							
Collaboration Services	4Projects, Asite, BIW, CADWeb							

Table 4.2 an outline map out of BIM tools into lifecycle stages (Crotty, 2012)

4.4 BIM Use in the Design Phase

Design is the core phase in which the majority of building project information is defined (Eastman et al., 2011). In other words, during the design phase, a considerable amount of data and information is generated by stakeholders to satisfy clients and code requirements (Sistani, 2013). BIM influences the design phase more than any other phases as most of the major decisions are made during this phase (Eastman et al., 2011). In addition, a project team can find ideas and offer solutions to different concerns prior to any problems incurring later in the process. Otherwise, the occurrence of such problems due to poor decision-making in the design phase can lead to high cost impacts on the project (Hergunsel, 2011). As illustrated in figure 4.1 changes can be made earlier in the project lifecycle to increase their influences on the project outcomes (Gaudin, 2013). Whenever a change is made in the project, all the consequences of that change are automatically coordinated throughout the project.

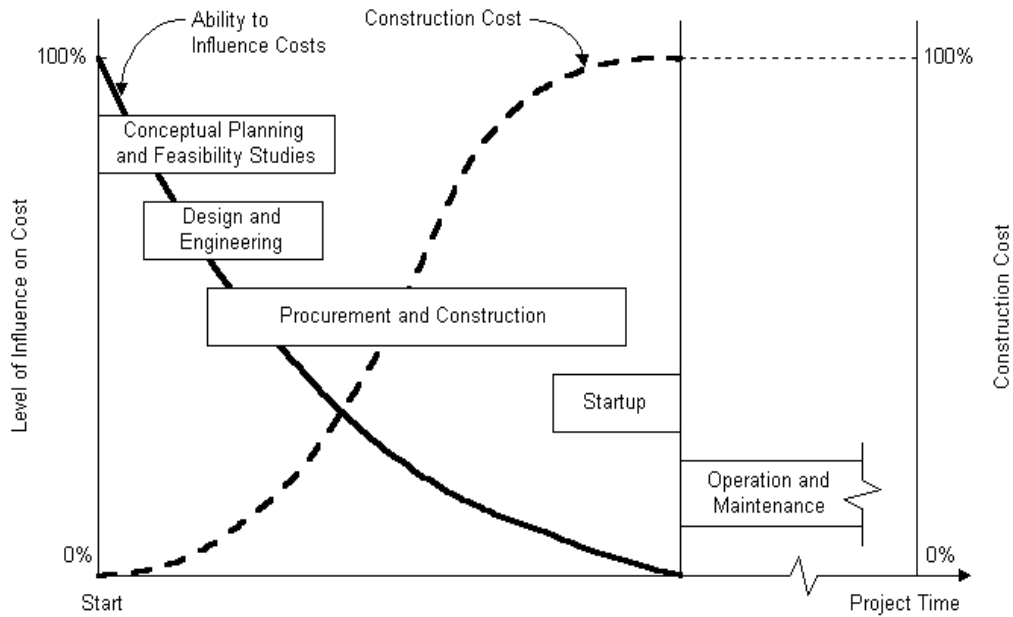

Figure 4.1 Level of influence of decisions in projects (Gaudin, 2013)

This allows the design team to deliver better work faster (Autodesk, 2003). The application of BIM is more evident in the design phase than it is in the construction and operation phases because there are many activities taking place during the design phase (Latiffi et al., 2013). These BIM applications are further elaborated in the subsections below and are linked with the corresponding design activities with reference to the RIBA Plan of Work 2013.

4.4.1 3D Visualization

A 3D model can be designed and produced automatically from a BIM application while manually developing it from a number of 2D drawings (Eastman et al., 2011). The 3D model increases the capability of understanding and visualizing what is being presented (Haron et al., 2009). Due to its intuitive nature, 3D visualization assists in quick and accurate evaluation by technical and non-technical staff (Underwood & Isikdag, 2010). For instance, in the Cookham Wood prison project in the UK, the prisoners, governor and staff from Ministry of Justice experienced walkthroughs of the 3D model at an early stage of design and then they suggested changes to suit their needs which, in turn, led to reducing the final cost by £800,000. See figure 4.2 for the 3D BIM model of the prison (Construction News, 2013). A good 3D visualization can utilise photo realistic representations and can make the construction tasks and processes easier to understand particularly for people who are not familiar with with field (Kiviniemi et al., 2011).

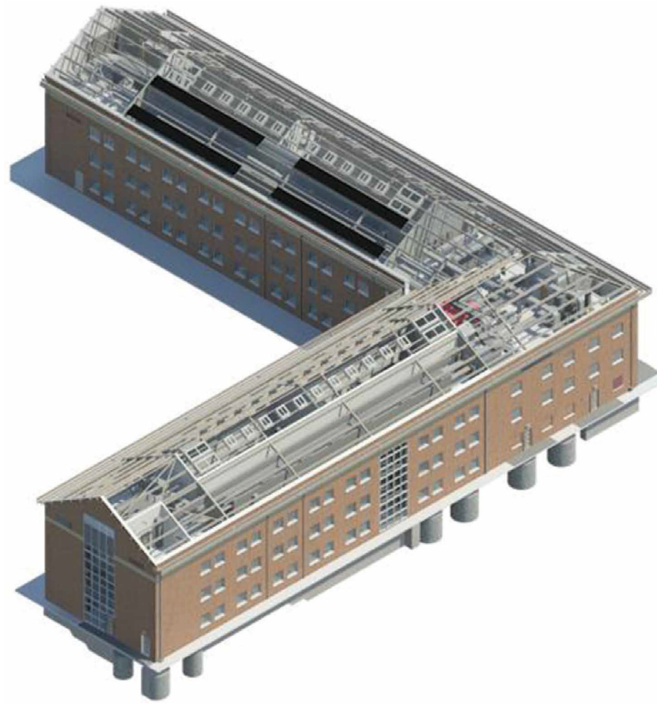

Figure 4.2 3D BIM model of Cookham Wood Prison (Construction News, 2013)

An advertisement for Volvo featuring a woman with her hands covering her eyes, suggesting a choice or a future. The background is a light green with a palm tree silhouette. The text asks "What do you want to do?" and describes the benefits of working for Volvo Group, including global operations and career opportunities. The Volvo logo and website information are at the bottom.

What do you want to do?

No matter what you want out of your future career, an employer with a broad range of operations in a load of countries will always be the ticket. Working within the Volvo Group means more than 100,000 friends and colleagues in more than 185 countries all over the world. We offer graduates great career opportunities – check out the Career section at our web site www.volvogroup.com. We look forward to getting to know you!

VOLVO
AB Volvo (publ)
www.volvogroup.com

VOLVO TRUCKS | RENAULT TRUCKS | MACK TRUCKS | VOLVO BUSES | VOLVO CONSTRUCTION EQUIPMENT | VOLVO PENTA | VOLVO AERO | VOLVO IT
VOLVO FINANCIAL SERVICES | VOLVO 3P | VOLVO POWERTRAIN | VOLVO PARTS | VOLVO TECHNOLOGY | VOLVO LOGISTICS | BUSINESS AREA ASIA



4.4.2 Site Modelling

A BIM model, with its geographical information, can be utilized to demonstrate the optimal site location for a project. For instance, Autodesk Revit Architecture contains massing and site tools which enable the user to create topography either by drawing contours and points directly or by importing Google Earth pictures. In addition, it has functionalities for merging and splitting surfaces, drawing property lines, grading regions, creating a building pad and other site elements such as plants, trees, daylight, parking, and so forth (Wang, 2011).

The 3D model of a site can be used to show the best location for the site based on a number of criteria such as access, light availability, position with relation to the sun, and others. In addition, the model can show materials, labour resources and associated deliveries (National Research Council of Canada, 2011). Finally, the integration of GIS with Building Information Modelling, which is also being researched, can help users select an appropriate site and conducting marketing studies and a project feasibility study (Azhar et al., 2012).

4.4.3 Design Authoring

Design authoring can be regarded as a process using BIM tools for Building Information Model development based on the design requirements being translated into the building design (CICRP, 2010). The set of 3D models produced includes the representation of the structural and architectural design, and models of MEP system elements (National Research Council of Canada, 2011). Design authoring tools are used to create these design models and to connect them with a powerful database containing information on specifications, schedules, costs, equipment properties, materials, etc. (Bloomberg et al., 2012).

4.4.4 Design Review

Design review is also regarded as a process in which a BIM model is used to evaluate the project programme and a set of criteria such as layout, sightlines, lighting, security, ergonomics, acoustics, textures and colours (Bloomberg et al., 2012). For example, a virtual mock-up can be performed in high detail for the analysis of the design alternatives and study constructability in an interactive environment (CICRP, 2010). These reviews will then lead to the elimination of possible construction problems at the early design stages and furthermore it can help decrease requests for information, rework, team conflicts, and change order (NRC, 2011).

4.4.5 Engineering Analysis

An engineering analysis is also a process, utilising intelligent modelling tools, that uses a BIM model to determine the most effective engineering method based on the design specifications (CICRP, 2010). In BIM, specialized analysis tools are used to simulate and analyse the performance of a building in different ways such as a structural analysis, a lighting analysis, a water harvesting analysis, an acoustic analysis, a mechanical analysis, an energy analysis, and so on (Foundation of the Wall and Ceiling Industry, 2009). The ability to conduct analyses on a digital model can help to reduce cost and can optimize a building's performance for its lifecycle (NRC, 2011).

Download free eBooks at bookboon.com

4.4.6 Code Validation

Code validation is a process with BIM software to check the model parameters against project specific codes (Bloomberg et al., 2012). These codes represent essential regulatory requirements for disabilities, safety and comfort or desired standards for sustainability such as LEED (National Research Council of Canada, 2011). The validation tools perform different functions (Eastman et al., 2008) as highlighted below:

- Check against programme requirements: this feature is used to compare the client requirements with the on-going design progress within various themes such as energy, spatial requirements, height and distance requirements for specific spaces or between spaces, and adjacency requirements. These checks can be undertaken by the client staff or by the design team.
- Validate building information model: BIM software such as Solibri Model Checker contains parametric rules that are applied against the model to check different aspects such as accessibility, model errors, elements, etc.

As a result, code validation tools allow the design team to reduce the chance of incurring design errors, omissions, and oversights (CICRP, 2010).



The advertisement features a runner in a red top and black leggings on a dirt path at sunrise. The Gaiteye logo is in the top left, with the tagline 'Challenge the way we run'. The main text reads 'EXPERIENCE THE POWER OF FULL ENGAGEMENT...'. Below this, a dotted line leads to the text 'RUN FASTER. RUN LONGER.. RUN EASIER...'. A hand cursor icon points to a yellow button that says 'READ MORE & PRE-ORDER TODAY WWW.GAITEYE.COM'. Technical diagrams of a foot and leg are overlaid on the runner's image.

qaiteye
Challenge the way we run

EXPERIENCE THE POWER OF FULL ENGAGEMENT...

**RUN FASTER.
RUN LONGER..
RUN EASIER...**

**READ MORE & PRE-ORDER TODAY
WWW.GAITEYE.COM**



4.4.7 Cost Estimation

Quantity take-off is the process for the determination of the amount of materials and items used in a particular construction project (Roginski, 2011). BIM is used to extract quantities automatically from the BIM model and estimate the cost of the project (Foundation of the Wall and Ceiling Industry, 2009). In addition, this process utilising BIM can help to compare the costs of various designs in order to make changes at the early design stages to avoid budget overruns (NRC, 2011).

A quantity take-off generated by a BIM tool from the model is much more accurate and reliable than one extracted manually through traditional methods which rely on the estimator to calculate quantities from paper drawings with a felt pen (Foundation of the Wall and Ceiling Industry, 2009).

In the BIM approach, BIM tools such as Autodesk QTO, Vico Takeoff Manager, Innovaya, and Exactal CostX can be linked directly to the BIM model for the automated extraction of quantities for the cost estimation process at early stage of design. While the design solution improves throughout the process, cost estimation improves too due to the detailed material quantities and the detailed spatial information in the BIM model (Eastman et al., 2011). This cost estimation process is illustrated in figure 4.3.

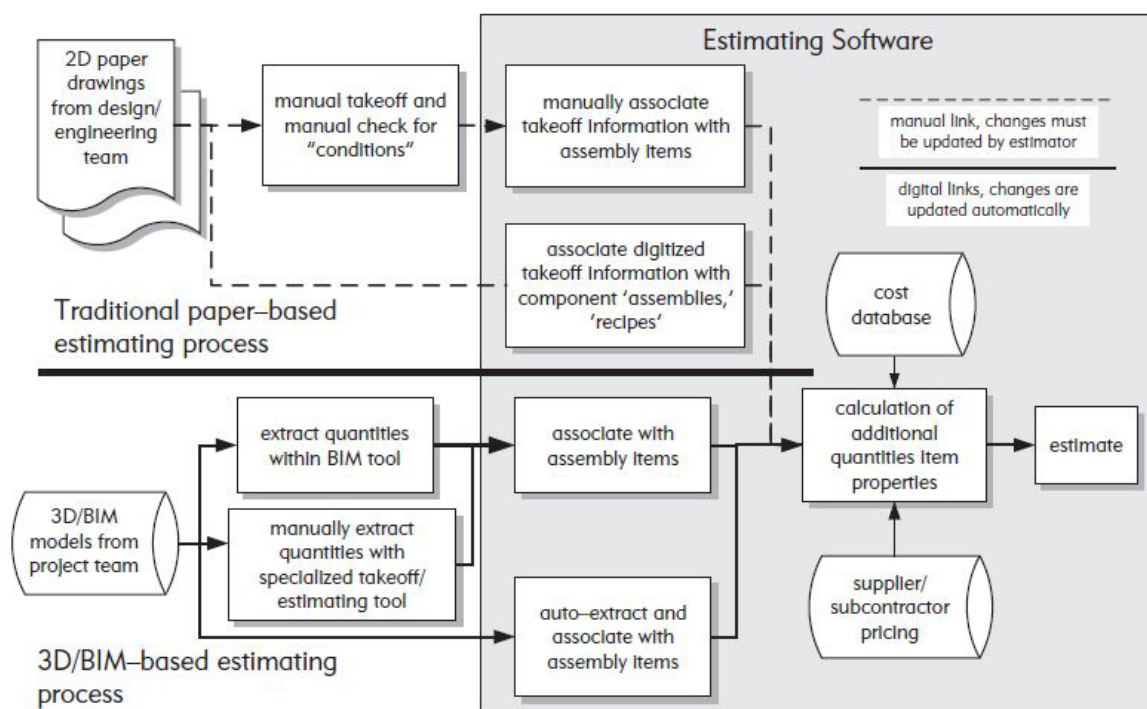

Figure 4.3 BIM quantity take-off and estimating process (Eastman et al., 2011)



4.4.8 Clash Detection

Clash detection is a process utilising clash detection software to determine conflicts by comparing 3D models of building systems (Bloomberg et al., 2012) in order to eliminate conflicts among the different systems prior to installation (Foundation of the Wall and Ceiling Industry, 2009).

Traditionally, clashes are detected by the manual process of overlying 2D drawings of various systems on a light table (Sistani, 2013). However, BIM technology can bring systems from all the disciplines together and compare them in order to detect clashes before they are detected on the construction site (Haron et al., 2009). Automatic detection of clashes is an important approach to determining design errors or omissions. If objects are too close to each other, it is regarded as soft clash or if objects overlap or occupy the same location, it is defined as hard clash (Eastman et al., 2011).

In fact, each stakeholder within design and construction uses different BIM tools and technologies to do their work (Eastman et al., 2011). For example, the architectural model can be designed and developed in Revit and Tekla can be used for structural design while Graphisoft's application can be used for HVAC and Bentley tool can be used for MEP. These programmes do not communicate with each other and subsequently cannot alert the project team when clashes occur (Foundation of the Wall and Ceiling Industry, 2009). Therefore, there are other BIM tools such as Navisworks that can bring 3D models from different platforms into a single platform to analyse and identify clashes (Foundation of the Wall and Ceiling Industry, 2009). Clash detection can reduce errors, shortening the actual construction period, reduce the cost of the project and, consequently, offer a smoother process for all stakeholders (Haron et al., 2009).



Design Stages according to the RIBA Plan of Work 2013	Design phase		
	 <p>2 Concept Design</p>	 <p>3 Developed Design</p>	 <p>4 Technical Design</p>
Tasks	<ol style="list-style-type: none"> 1. Preparation of Concept Design, including outline proposals for structural design and services' systems. 2. Proposal of site landscape and general spatial layout. 3. Communication of design 	<ol style="list-style-type: none"> 1. Prepare Developed Design, including coordinated and updated proposals for structural design, building services' systems. 2. Preliminary cost information 3. Communication of design 	<ol style="list-style-type: none"> 1. Prepare Technical Design in accordance with the Design Responsibility Matrix and Project Strategies to include all architectural, structural and MEP information. 2. Review and sign-off of Performance Specified Work and other information by the Lead Designer. 3. Simulate and analyse the building's performance. 4. Check the model parameters against project specific codes. 5. 3D coordination to determine field conflicts. 6. Cost information
BIM applications	<ol style="list-style-type: none"> 1. Design Authoring for the outline proposal of structural design 2. Site modelling can be used to demonstrate the optimal site location for a project 3. 3D Visualisation for effective communication of design ideas amongst the actors for shared understanding 	<ol style="list-style-type: none"> 1. Design Authoring for updating the Building Information Model 2. Cost Estimation to extract quantities automatically from the model and estimate the cost of the project 3. 3D Visualisation for effective communication of design ideas amongst the actors for shared understanding 	<ol style="list-style-type: none"> 1. Design Authoring to generate Building Information Models (architectural, structural and MEP systems). 2. Design Review to evaluate the programme and set criteria. 3. Engineering analysis such as structural analysis, lighting analysis and others. 4. Code Validation to check requirements for disabilities, comfort, safety etc. 5. Clash Detection to identify conflicts among different systems. 6. Cost Estimation to extract quantities automatically from the model and estimate the cost of the project.



<p>BIM tools</p>	<ol style="list-style-type: none"> Design Authoring such as ArchiCAD, Vectorworks and Bentley Architecture Site modelling such as Autodesk Revit Architecture, LANDCADD (Eagle Point), and others 3D Visualisation is provided by the many BIM authoring and design review tools 	<ol style="list-style-type: none"> Design Authoring such as Revit, Tekla or equal Cost Estimation such as Autodesk QTO, Vico Takeoff Manager, Innovaya, and Exactal CostX 3D Visualisation is provided by the many BIM authoring and design review tools 	<ol style="list-style-type: none"> Design Authoring such as Tekla Structures, ArchiCAD, Revit MEP, CAD-Duct, SDS/2, CAD-Pipe, Bentley Systems or equal Design Review: by using BIM software only such as Autodesk Revit or the model can be exported to special virtual mock-up facilities, such as CAVE (Computer Assisted Virtual Environment) and immersive lab Engineering analysis Green Building Studio, Ecotec, Robot, Acoustical Room Modelling Software, Digital Project, Energy Plus, TRNSYS, Fluent, Carrier E20-II and GTSTRUDL Code Validation such as Solibri Model Checker. Clash Detection such as Navisworks and Bentley Navigator, Tekla BIMsight, and EPM Model Server. Cost Estimation such as Autodesk QTO, Vico Takeoff Manager, Innovaya, and Exactal CostX.
<p>LOD</p>	<div style="display: flex; justify-content: space-around; align-items: center;"> <div style="text-align: center;"> <div style="background-color: #00bfff; padding: 5px; margin-bottom: 5px;">LOD 100</div>  </div> <div style="text-align: center;"> <div style="background-color: #ffeb3b; padding: 5px; margin-bottom: 5px;">LOD 200</div>  </div> <div style="text-align: center;"> <div style="background-color: #4caf50; padding: 5px; margin-bottom: 5px;">LOD 300</div>  </div> </div>		
<p>Output</p>	<div style="display: flex; justify-content: space-around; align-items: center; margin-top: 20px;"> <div style="text-align: center;">  <p>Architectural Model</p> </div> <div style="text-align: center;">  <p>Structural Model</p> </div> <div style="text-align: center;">  <p>MEP</p> </div> </div>		

Table 4.3 BIM applications and tools in the design phase (LOD photos from Van, 2008)

4.5 BIM uses in the Construction Phase

BIM has benefits for the project team during the actual construction phase too; it provides a smoother and better planned construction process that minimizes conflicts and errors and saves money and time (Eastman et al., 2011). To be precise, the use of BIM in the construction phase has proven beneficial in coordinating construction site activities, people and materials to minimize conflicts and reduce construction delays, resulting in greater production efficiencies (National Research Council of Canada, 2011). The following BIM applications are possible in the construction phase and are summarised in table 4.4.

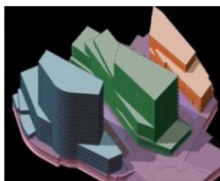
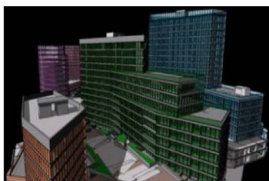
4.5.1 Digital fabrication

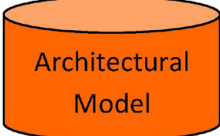
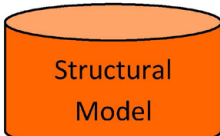
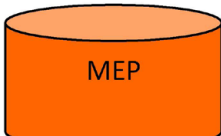
Digital fabrication is an activity based on machine technology for prefabricating objects directly from a 3D model (Bloomberg et al., 2012). For example, a CNC machine is utilised for making different sections of piping, ductwork and other building objects under a controlled environment in fabrication shops (Forbes & Ahmed, 2010). The level of construction information in a BIM model forms the basis for fabricated components (Sistani, 2013). Consequently, the design model in BIM can be linked with the BIM compliant fabrication tools to generate a set of shop drawings (Eastman et al, 2011). Such offsite work is more accurate than onsite work and leads to reduced cost and construction time (Forbes & Ahmed, 2010).

BIM also has capacity for prefabrication. The design details can be readily converted to construction shop drawings and prefabrication instructions for subassemblies (Forbes & Ahmed (2011). In fact, subcontractors and fabricators should be provided with a set of shop drawings to represent the installer's interpretation of the architectural drawings and how the work will be installed and manufactured in order to meet the requirements of the design drawings and specifications (Sheata, 2011). Using BIM for fabrication does help to avoid problematic and difficult steps in the construction process (Khoshnava et al., 2012).



www.sylvania.com

We do not reinvent
the wheel we reinvent
light.

Fascinating lighting offers an infinite spectrum of possibilities: Innovative technologies and new markets provide both opportunities and challenges. An environment in which your expertise is in high demand. Enjoy the supportive working atmosphere within our global group and benefit from international career paths. Implement sustainable ideas in close cooperation with other specialists and contribute to influencing our future. Come and join us in reinventing light every day.

Light is OSRAM

OSRAM
SYLVANIA



3D fabrication can be used for different parts of the building such as **precast concrete** (reinforcing, custom shapes and patterns), **glazing systems** (details, connections and customized assembly systems), **CIP concrete** (component numbering, reinforcing layouts), **specialty items** (sunshades, brackets and custom handrails), **MEP components** (piping, equipment, conduit, ductwork), **structural steel** (bracing, joists, rebar, beams and columns), and **other items** (sculpture, site features, signage, furniture) (Hardin, 2009).

Overall, prefabricated materials will necessitate more construction work to be performed offsite in optimal factory conditions which, in turn, reduces error and accidents on site (Khoshnava et al, 2012). A number of BIM tools for fabricators and sub-contractors are listed in table 4.4.

BIM Software	Building System Compatibility	Functionality	Source for Information
Tekla Structure	Structural steel, Precast concrete, CIP reinforced concrete, Mechanical, Electrical, Plumbing, Curtain walls	Modelling, analysis pre-processing, fabrication detailing, coordination	www.tekla.com
SDS/2 Design Data	Structural steel	Fabrication detailing	www.dsndata.com
StruCAD	Structural steel	Fabrication detailing	http://www.acecadsoftware.com/
Revit Structure	Structural steel, CIP reinforced concrete	Modelling, analysis, pre-processing	www.autodesk.com/revit
Revit MEP	Mechanical, Electrical, Plumbing and piping	Modelling	www.autodesk.com/revit
3d+	Structural steel	Modelling	http://www.3d-plus.com/
Structureworks	Precast concrete	Modelling, fabrication detailing	www.structureworks.net
Revit Architecture	Curtain walls	Modelling	www.autodesk.com/revit
aSa Rebar Software	CIP reinforced concrete	Estimating, detailing, production, material tacking, accounting	www.asarebar.com
Allplan Engineering	Structural steel, CIP reinforced concrete, precast concrete	Modelling, detailing rebar	www.allplan.com
Allplan Architecture	Curtain walls	Modelling	www.allplan.com
Catia (Digital Project)	Curtain walls	Modelling, FEM analysis, parsing production data for CNC	www.3ds.com
Graphisoft ArchiGalzing	Curtain walls	Modelling	www.graphisoft.com
SoftTech V6	Curtain walls	Modelling and fabrication detailing	www.softtechnz.com
CADPipe Commercial Pipe	Piping and plumbing	Modelling and fabrication detailing	www.cadpipe.com
CADPIPE HVAC and Hanger	HVAC ducts	Modelling and fabrication detailing	www.cadpipe.com

BIM Software	Building System Compatibility	Functionality	Source for Information
CADPIPE Electrical and Hanger	Electrical conduits, cable trays	Modelling, detailing	www.cadpipe.com
Quickpen PipeDesigner	Piping and plumbing	Modelling, fabrication detailing	www.quickpen.com
Quickpen DuctDesigner	HVAC	Modelling, fabrication detailing	www.quickpen.com
Bentley Building Mechanical Systems	HVAC ducts and piping	Modelling	www.bentley.com
Graphisoft MEP Modeller	HVAC ducts, piping, cable trays	Modelling	www.graphisoft.com
CADmep+ FABmep+	HVAC ducts, piping	Modelling and fabrication detailing	www.mapsoftware.com
SprinkCAD	Fire Sprinkler systems	Modelling and fabrication detailing	www.sprinkcad.com
Frameworkright Pro	Wood framing	Modelling and fabrication detailing	www.encia.co.uk/frameworkright_pro.html
MWF – Metal Wood Framer	Light-gauge steel and wood framing	Modelling and fabrication detailing	http://strucsoftsolutions.com/

Table 4.4 BIM tools for fabricators and sub-contractors

4.5.2 Onsite usage (Mobile BIM)

Human related mistakes may occur at the construction stage even though the BIM model is accurate and avoids errors and omissions at the design phase (Sistani, 2013). The advanced technologies such as tablets and Smartphone offers the opportunity to stakeholders such as subcontractor and contractor to use BIM models on construction site for coordination and information extraction with BIM applications such as Buzzsaw, Bentley Navigator, BIMX, and Autodesk 360. These tools can be used to share BIM models in web environment and perform different activities at the jobsite such as clash detection, walk through, and others (Azhar et al, 2012).

4.5.3 Laser scanning

3D laser scanning technology accurately captures existing building details and can be linked with BIM technology in order to provide information about the facility for BIM modelling (Azhar et al., 2012). In other words, it can be used to prepare as-built details or verifying a situation such as RFID (Radio Frequently Identification) technology for the tracking of material delivery status, GPS (Global Positioning Systems) to verify locations, and Machine-guidance technology for grading and excavation activities (Sistani, 2013).

Laser scanning can be considered as a good quality control tool for new projects and for renovations' projects that do not have a 3D model. In such cases, laser scanning can be used to identify the status of the building components and location and to develop a 3D BIM model (Hergunsel, 2011).

4.5.4 Sequential Construction Planning

Sequential planning is a process utilising a 4D BIM model for graphically representing both permanent and temporary facilities on site together with the construction activity schedule (CICRP, 2010). The temporary components include fencing, lorries and cranes and traffic access routes for lifts, cranes, lorries. Some other components can also be included in the model as part of a logistics plan as illustrated in figure 4.4 (Khoshnava et al., 2012).

Some BIM applications have the ability to link the 3D model with the construction plan to generate a 4D model (Haron et al., 2009). More specifically, the 3D building model is equipped with a time dimension (Kiviniemi et al., 2011). The 4D model is used to check, optimize, and preview the construction process in a dynamic way (Li-jia, Rong-yue, & Xiao-sheng, 2013).

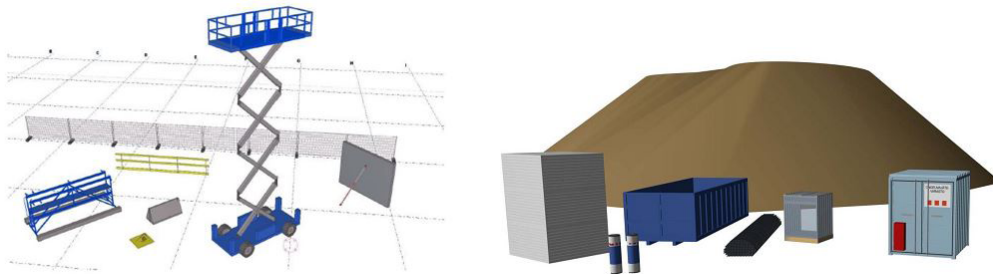

Figure 4.4 Site and safety planning objects produced in Tekla (Kiviniemi et al., 2011)



360°
thinking.

Discover the truth at www.deloitte.ca/careers



© Deloitte & Touche LLP and affiliated entities.

This graphic simulation offers the opportunity to the project team to see how the project will be built day by day and exposes potential problems such as design errors and omissions. Accordingly, these potential problems can be addressed before the actual construction with no cost (Eastman et al., 2011). Furthermore, 4D modelling is also used to discover potential hazards at an early stage of the project and multiple activities such as scaffolding systems, rails, fences, etc. can be modelled and simulated to identify risk and prevent accidents (Lopez del Puerto & Clevenger, 2010). Table 4.5 presents a list of 4D simulation tools.

Company	BIM Tool	Description
Bentley	Project Wise Navigator	This is a standalone application providing a series of services for: <ol style="list-style-type: none"> 1. Importing multiple 2D and 3D design files from many sources (DWG, DGN, DWF, etc.) 2. Reviewing 2D drawings and 3D Models concurrently 3. Following links between data files and components 4. Reviewing interferences (clashes) and viewing and analysing schedule simulations
CommonPoint	Project 4D construction	<ol style="list-style-type: none"> 1. CommonPoint 4D includes some specialised 4D features, e.g. Conflict analyses, adding laydown objects, animation, and custom features to create 4D movies. 2. The 4D linking process includes drag-drop manual linking and automatic linking. 3. Users can distribute a 4D viewer to team members. CommonPoint 4D only imports vrmf geometry via exporters to popular BIM tools with limited object meta-data, and users can import from all the major schedule software products. 4. The higher end ConstructSim supports more data rich imports of more formats with high end analysis, organisation, and status visualisation features.
Innovaya	Visual Simulation	<ol style="list-style-type: none"> 1. Links any 3D design data in DWG with either MS Project or primavera scheduling tasks and shows projects in 4D. 2. Generates simulation of construction process. 3. Synchronises changes made to either the schedule or to the 3D objects. 4. Uses colour codes to detect potential schedule problems such as objects assigned to two concurrent activities or not assigned to any activity
Navisworks	JetStream Timeliner	<ol style="list-style-type: none"> 1. The timeliner module includes all the features of JetStream's visualisation environment 2. Supports the largest number of BIM formats and best overall visualisation capabilities. 3. Supports automatic and manual linking to imported schedule data from a variety of schedule applications. 4. Manual linking is tedious and not user-friendly and there are few custom 4D features.
Syncro Ltd	Syncro 4D	<ol style="list-style-type: none"> 1. A powerful new 4D tool with the most sophisticated scheduling and project management compared with other tools 2. Incorporates risk and resource analysis features. 3. Include built in tools to visualise risk, buffering, and resource utilisation in addition to basic 4D visualisation

VicoSoftware	Virtual Construction	<ol style="list-style-type: none"> 1. 5D construction planning system consisting of Constructor, Estimating, Control and 5D Presenter. 2. The building model is developed in Constructor, and 3. Assign objects with recipes that define the tasks and resources needed to build or fabricate them, 4. Quantities and costs are calculated in Estimator, 5. Schedule activities are defined and planned using the balance techniques in Control 6. 4D construction simulation is visualised in Presenter. 7. As an alternative to using Control, schedule dates can be imported from Primavera and MS Project
--------------	----------------------	--

Table 4.5 4D BIM Tools (Eastman et al., 2008)

4D modelling is a powerful way of communicating and visualizing to understand construction plans and project milestones to identify issues and avoid spatial conflicts before actual construction (Bloomberg et al., 2012).

4.5.5 Site coordination plans

Site coordination for the construction team is critical particularly when dealing with challenging sites or dense urban environments (Azhar et al., 2012). In this regard, BIM provides opportunities such as walk-through videos and perspectives' views to show zones to site teams in order to avoid any conflict or clashes during certain periods on the construction site, and to show vehicular accessibility, scaffolding equipment, and material hoists, to improve safety onsite for workers, and to check crane swings as illustrated in figure 4.5. These views can be created through the use of a path of Revit into Navisworks or Revit into Google SketchUP (Hardin, 2009).



Figure 4.5 Visualization of crane swings (Khoshnava et al., 2012)

<p>Construction stage according to the RIBA Plan of Work 2013</p>	<p>Construction phase</p> 
<p>Tasks</p>	<ol style="list-style-type: none"> 1. Offsite manufacturing in accordance with Construction Programme. 2. Onsite Construction in accordance with Construction Programme. 3. Review Construction Strategy including sequencing and critical path. 4. Preparations and Installation of protection requirements. 5. Control the quality of work.
<p>BIM Applications</p>	<ol style="list-style-type: none"> 1. Digital Fabrication to generate a set of shop drawings and then CNC machine can be provided with instructions for making different sections. 2. Onsite Usage for coordination and information extraction. 3. Sequential planning (4D) to demonstrate both temporary and permanent facilities onsite with construction schedule activities. 4. Site coordination plans to improve safety onsite for crews. 5. Laser scanning for verifying situation (quality control).

SIMPLY CLEVER

ŠKODA



We will turn your CV into an opportunity of a lifetime



Do you like cars? Would you like to be a part of a successful brand? We will appreciate and reward both your enthusiasm and talent. Send us your CV. You will be surprised where it can take you.

Send us your CV on www.employerforlife.com



<p>BIM tools</p>	<ol style="list-style-type: none"> 1. Digital fabrication such as Tekla Structures, StruCAD, SDS/2 Design Data, Structureworks, Allplan Engineering, SoftTech V6, CADPIPE Commercial Pipe, Framewright Pro and Quickpen DuctDedesigner. 2. Onsite usage e.g. Buzzsaw, Bentley Navigator, BIMX, and Autodesk 360. 3. Sequential planning (4D) such as Navisworks, Synchro Ltd, Innovaya and CommonPoint. 4. Site Coordination Plans can be created by using a path of Revit into Navisworks or Revit into Google SketchUP. 5. Laser scanning such as Trimble Realworks software which has the ability to combine 3D scanning, imaging and position data.
<p>LOD</p>	
<p>Output</p>	

Table 4.6 BIM applications and tools in the construction phase

4.6 BIM Usage in the Operation Phase

Traditionally, the majority of building information is stored as paper documents and the building, as the final product, is handed over with boxes and piles of owner warranties and manuals (Teicholz, 2013). One of the largest problems in dealing with end-of-project information is the huge amount of documentation owners are left to deal with (Harden, 2009). Many problems arise when as-built drawings do not match with the actual construction and engineering changes (Li-jia, Rong-yue, & Xiao-sheng, 2013). However, BIM offers one model for storing all data about a building and its systems, components and spaces (Akcamete et al., 2010). This information can be leveraged for downstream use by facility managers thereby making operations and maintenance of a facility more efficient (Azhar et al., 2012). More specifically, when a model is generated by the project team and updated throughout the construction stage, it has the ability to become the “as-built” model, which can be handed over to the owner; this model contains all specifications, maintenance and operation manuals, and warranty information (Khoshnava et al., 2012).

As a result, BIM provides the ability to transfer the facility data from the design and construction stages to the operation stage and some commercial systems offer automated transfer of facility data from Building Information Modelling tools to Computerized Maintenance Management Systems (CMMS) or Computer Aided Facility Management (CAFM) (Akcamete et al., 2010).

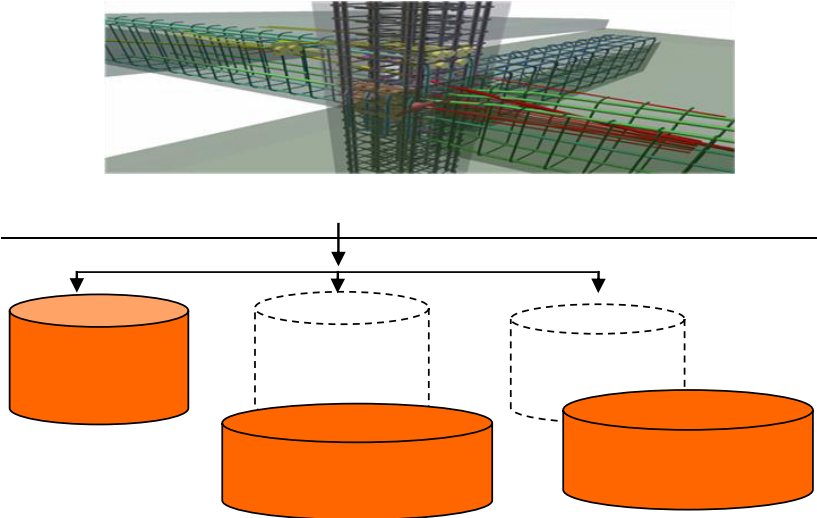
Likewise, the international interoperability standard COBie (Construction Operations Building information exchange) provides a framework to store data throughout the design and construction process (Eastman et al., 2011). COBie allows the retrieving of necessary facility information from a BIM capturing maintenance plan and system instructions through a speared sheet, and the importing of the facility data to CMMS (Akcamete et al, 2010). The subsections below describe the operation activities in which BIM is in active use.

4.6.1 Record Model

A record model depicts an accurate representation of the physical conditions, environment, and assets of a facility (Bloomberg et al., 2012). The contractor hands over a record model to the building owner at the end of the construction phase for the facilitation of operation, maintenance and renovation (Hergunsel, 2011).

This model contains different information about a building such as the pre-build specifications, the design and the actual as-built details in relation to the structure, architecture, MEP, electrical, and component information such as warranties, product data, maintenance history and schedules, and serial numbers (National Research Council of Canada, 2011). A record model represents an authoritative source of information that is used to plan and execute changes during the lifecycle of a building (Underwood & Isikdag, 2010). Therefore, a project team should continuously update the BIM model so that it will reflect the most up-to-date information for the efficient and effective use of building operations and maintenance (Azhar et al., 2012).

4.6.2 Asset Management

Asset management can be considered as an organized management system for the efficient maintenance and operation of a facility and its assets (CICRP, 2010). These assets include equipment, systems and the physical building which have to be upgraded, operated and maintained at an efficiency level with the lowest appropriate cost to satisfy the owner and users (Bloomberg et al., 2012).

Asset management uses information that is included in the record model to show various scenarios for organizing the equipment and workspaces in order to optimize space utilization, organize objects, and track the movement and relocation of furniture and other building equipment effectively (National Research Council of Canada, 2011). The data in the record model can also be used to demonstrate the cost implications of upgrading and changing building assets (Bloomberg et al., 2012).

4.6.3 Disaster Planning

Disaster planning is essential so that emergency responders have critical building information in the form of a model and information system (CICRP, 2010). For example, while the dynamic building data is provided by BAS (Building Automation System), the static building information such as stairways, hallway, floors, etc. can be found in a BIM model (National Research Council of Canada, 2011). The BIM model can be linked to the BAS system to manage safety and security information such as the sprinkler systems, smoke detectors, fire alarms, fire extinguishers, egress, emergency power, emergency lighting, location of any emergency situation within the building and possible routes to exit (CICRP, 2010; Liu et al., 2011; Hergunsel, 2011).

4.6.4 Building Performance Management

Similar to the engineering analysis and simulation utilised during the design phase, the facility management team uses BIM for the analysis of building performance for the efficient and effective use of the building (while facilitating user demand and maintaining comfort). BIM can also be used for the provision of possible options for retrofits in existing buildings (National Research Council of Canada, 2011). Such analyses comprise how much energy a building uses, how the mechanical system operates, a solar analysis, external and internal airflow, a lighting analysis, and ventilated facade studies (CICRP, 2010).



I joined MITAS because
I wanted **real responsibility**

The Graduate Programme
for Engineers and Geoscientists
www.discovermitas.com

Month 16
I was a construction
supervisor in
the North Sea
advising and
helping foremen
solve problems

Real work
International opportunities
Three work placements









Operation stages in accordance with the RIBA Plan of Work 2013	Operation phase	
	 <p>6 Handover and Closeout</p>	 <p>7 In Use</p>
Tasks	<ol style="list-style-type: none"> Handover of building, conclusion of building contract, commissioning, feedback for use during the life of the building and updating of Project Information as required (as-built information) 	<ol style="list-style-type: none"> Review of Project Performance in use and analysis of Project Information for use on future projects Updating of Project Information, as required, in response to Asset Management and Facilities Management feedback and Modifications Implementation plan for emergency response
BIM applications	<ol style="list-style-type: none"> Record Model to provide owner with accurate model of building, equipment and spaces 	<ol style="list-style-type: none"> Building Performance for analysis of the operating performance of a building Asset Management for tracking the use, performance and maintenance of a building's assets Disaster Planning for managing safety and security information
BIM tools	<ol style="list-style-type: none"> Record Model: BIM Authoring Tools to update and add information to the model such as Revit, ArchiCAD, CAD-Duct, SDS/2, Bentley Systems and others 	<ol style="list-style-type: none"> Building Performance: BIM Analysis tools such as Green Building Studio, Ecotect, Robot, Acoustical Room Modelling Software, Digital Project, Energy Plus, TRNSYS,Fluent, Carrier E20-II and GTSTRUDL. Asset Management: Autodesk FMDesktop, Bentley Facilities, Onuma System and EcoDomus FM. Disaster Planning: Building Automation System (BAS) can be linked with the Record Model.
LOD	LOD 500	LOD 500
Outcome		

Table 4.7 BIM applications and tools in the operation phase

4.7 Free BIM Tools in the Design Process

There are also free BIM tools to use in design and construction workflows for different applications such as cost estimation, design authoring and 3D coordination. Table 3.7 lists the free BIM tools available to support stakeholders, describing their advantages and disadvantages in order to provide a more insightful view about them; it also indicates their possible integrated use with commercial tools.

Although there are large number of free BIM tools, most of them are the model viewers. Tekla BIMsight, as a free tool, has almost the same features as Navisworks Manage (except the 4D planning and rendering) which makes it attractive and usable for similar usage. Another tool is SkyBIM. There is, as yet, no commercial tool similar to this. It still needs to be tested in real cases.

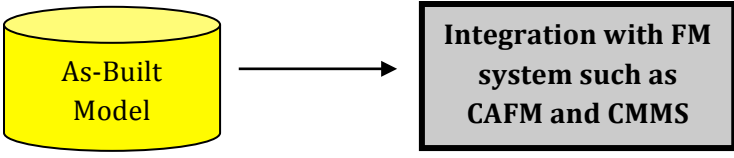
The usability of these viewers which have been tested is high. Although the DDS CAD is the hardest software to use, given the ease of use of these viewers, they can be straightforward to implement without the need of highly skilled staff to manipulate the tool for model viewing and analysis.

The most common BIM uses supported by the free tools that have high usability are design authoring and 3D coordination. The open standard format IFC can be manipulated with success but not all of them can be manipulated thus, for example, SkyBIM has the disadvantage of only working with Revit software.

Use of the free BIM tools can be expanded into other lifecycle stages. For example, there is software that can be suitable for construction and FM stages such as xBIM Xplorer which can export the data in a COBie spreadsheet, and Tekla BIMsight could be used in the construction stage to link the equipment data with the model in order to develop a facility management model.

Application/Use	BIM Tools	Advantages	Disadvantages
Cost Estimation	SkyBIM	User friendly interface Similar spread sheet to Excel Data shared in cloud service	Only works with Revit Very new, no case study on its implementation
Design Authoring and 3D Coordination	TeklaBIMsight	Manages multiple models Attaches documents Simple Navigation Clash Detection Good interoperability (IFC and BCF) Easy to use	It is not possible to share views
	IFC exporter	Automated generation of IFCzip files in Revit, allowing export in parts by levels or by areas	Only works with Revit
	Solibri IFC Optimizer	Transforms IFC files in IFCzip reducing the size until 95%	
	DriveEye	Sends notification emails when a file is modified in Gdrive cloud	
	Syncbackup	Backs up files in Gdrive automatically	2GB of free space to backup files
	BCF Viewer	Reviews BCF/BCFzip files	It is not possible to reply to queries in the file, just to see the problem
	TeklaBIMsight Note	Reviews BCF/BCFzip files Answers queries	The colours in the picture are missing when a question is answered using BIMsight Note

Table 4.8 Free BIM tools for some design applications

ie business school

#1 EUROPEAN BUSINESS SCHOOL
FINANCIAL TIMES 2013

#gobeyond

MASTER IN MANAGEMENT

Because achieving your dreams is your greatest challenge. IE Business School's Master in Management taught in English, Spanish or bilingually, trains young high performance professionals at the beginning of their career through an innovative and stimulating program that will help them reach their full potential.

- Choose your area of specialization.
- Customize your master through the different options offered.
- Global Immersion Weeks in locations such as London, Silicon Valley or Shanghai.

Because you change, we change with you.

www.ie.edu/master-management | mim.admissions@ie.edu | Facebook | Twitter | LinkedIn | YouTube | Instagram

Download free eBooks at bookboon.com



4.8 References

- Akcamete, A., Akinci, B. & Garrett, J.H. (2010), Potential utilization of building information models for planning maintenance activities, In *Proceedings of the international conference on computing in civil and building engineering: 30 June-2 July 2010*, (pp. 151–157). Nottingham, UK, <http://www.engineering.nottingham.ac.uk/iccbe/proceedings/html/76.htm>
- Azhar, S. & Brown, J., (2009), BIM for sustainability analyses, *International Journal of Construction Education and Research*, 5(4), 276–292, doi: 10.1080/15578770903355657.
- Azhar, S., Khalfan, M. & Maqsood, T. (2012), Building information modelling (BIM): now and beyond. *Australasian Journal of Construction Economics and Building*, 12(4), 15–28.
- Bloomberg, M.R., Burney, D. J. & Resnick, D. (2012), BIM Guidelines, Retrieved from http://www.nyc.gov/html/ddc/downloads/pdf/DDC_BIM_Guidelines.pdf
- Brewer, G., Gajendran, T. & Goff, R.L. (2012), Building Information Modelling (BIM): an Introduction and International Perspectives: Research report. Retrieved from <http://www.tbcitb.com.au/>
- Bryde, D., Broquetas, M. & Volm, J.M. (2013), The project benefits of Building Information Modelling (BIM), *International Journal of Project Management*, 31(7), 971–980. Retrieved from <http://dx.doi.org/10.1016/j.ijproman.2012.12.001>
- Çetiner, O (2010), A Review of Building Information Modelling Tools from an Architectural Design Perspective, *Handbook of research on building information modelling and construction informatics: Concepts and technologies* (2010): 19–28.
- CICRP, (2010), BIM Execution Planning Guide: version 2.0, Retrieved from <http://strucsoftsolutions.com/>
- Construction news, (2013), BIM Supplement, Retrieved from <http://www.cnplus.co.uk/home/digital-editions/bim-a-construction-news-supplement-june-2013/8649356.article?blocktitle=Previous-digital-editions&contentID=5437>
- Crotty, R. (2012). *The Impact of Building Information Modelling: Transforming construction*, Spon Press, London.
- Eastman, C.M., Teicholz, P., Sacks, R. & Liston, K. (2008), *BIM Handbook: A guide to building information modelling for owners, managers, architects, engineers, and contractors*. Hoboken, N.J.: Wiley.

Eastman, C., Teicholz, P., Sacks, R. & Liston, K. (2011), *BIM Handbook: A Guide to Building Information Modeling for Owners, Managers, Designers, Engineers, and Contractor*. (2nd ed.), Hoboken, N.J.: Wiley.

Forbes, L. & Ahmed, S. (2010), *Modern Construction: Lean Project Delivery and Integrated Practices (Industrial Innovation Series)*, (1st ed.), US: CRC Press.

Foundation of the Wall and Ceiling Industry, (2009), *Building Information Modelling: Understanding and Operating in a New Paradigm*, Retrieved from <http://www.awci.org/pdf/bim.pdf>

Gaudin, B. (2013), *Impacts of Building Information Modelling (BIM) on Project Management in the French Construction Industry*, (MSc thesis), University of Birmingham, Birmingham.

Hardin, B. (2009), *BIM and Construction Management: Proven Tools, Methods, and Workflows*, San Francisco, California: John Wiley.

Haron, A.T., Marshall-Ponting, A.J. & Aouad, G., (2009), *Building information modelling in integrated practice*, In *2nd Construction Industry Research Achievement International Conference: 3rd – 5th November 2009*, Kuala Lumpur, Malaysia. Retrieved from <http://usir.salford.ac.uk/16624/>

Hergunsel, M.F. (2011), *Benefits of building information modelling for construction managers and BIM based scheduling*. (MSc thesis), Worcester Polytechnic Institute, Worcester, Retrieved from <http://www.wpi.edu/Pubs/ETD/Available/etd-042011-135239/>

Jiang, X. (2011), *Developments in cost estimating and scheduling in BIM technology*, (MSc thesis), Northeastern University, Boston, Massachusetts.

Khosnava, S.M., Ahankoob, A., Preece, C. & Rostami, R. (2012), *Potential Application of BIM in Construction Disputes and Conflict*, In *Management in Construction Research Association (MiCRA) conference*, Malaysia.

Kiviniemi, M., Sulankivi, K., Kähkönen, K., Mäkelä, T. & Merivirta, M. (2011), *BIM-based safety management and communication for building construction*, *A report published by VTT Technical Research Centre of Finland*, Tampere, Finland.

Krygiel, E. & Nies, B. (2008), *Green BIM: Successful Sustainable Design with Building Information Modelling*, (1st ed.). Canada: Wiley.

Latiffi, A.A., Mohd, S., Kasim, N. & Fathi, M. S. (2013), Building Information Modelling (BIM) Application in Malaysian Construction Industry, *International Journal of Construction Engineering and Management*, 2(4A), 1–6. doi: 10.5923/s.ijcem.201309.01.

Li-jia, W., Rong-yue, Z., Xiao-sheng, J. (2013), The Application of BIM in the Completion Phase, In *Digital Manufacturing and Automation (ICDMA)*, Fourth International Conference on: 29–30 June 2013, (pp. 1392–1395), IEEE. doi: 10.1109/ICDMA.2013.332.

Liu, Q., Gao, T. & Wang, J. (2011), Research on application of BIM technology in construction project. In *Computer Science and Service System (CSSS)*, International Conference on: 27–29 June 2011, (pp. 2463–2467), IEEE. doi: 10.1109/CSSS.2011.5974366.

Lopez del Puerto, C., Clevenger, C. (2010), Enhancing Safety throughout Construction using BIM/VDC, In *EcoBuild Proceedings of the BIM-Related Academic Workshop*, Washington D.C.

Moakher, P.E. & Pimplikar, S.S. (2012), Building Information Modelling (BIM) and Sustainability – Using Design Technology in Energy Efficient Modelling, *IOSR Journal of Mechanical and Civil Engineering (IOSRJMCE)*, 1(2), 10–21. Retrieved from <http://www.iosrjournals.org/>



"I studied English for 16 years but...
...I finally learned to speak it in just six lessons"
Jane, Chinese architect

ENGLISH OUT THERE

Click to hear me talking before and after my unique course download



National Research Council of Canada, (NRC) (2011), *Environmental Scan of BIM Tools and Standards*, Institute of BIM for Canada.

Roginski, D. (2011), *Quantity Take-off process for bidding stage using BIM tools in Danish Construction Industry*, (MSc thesis), Technical University of Denmark, Denmark, Retrieved from, www.bim.byg.dtu.dk/~media/Subsites/BIM/bim/uddannelse/eksamensprojekter/qtobim/master_thesis_quantity_takeoff_process_for_bidding_stage_using_bim_tools_in_danish_construction_ind.ashx

Sheata, W. (2011), *Identifying the areas where Building Information Modelling software adds value for general contractors working in the State of Colorado*, (MSc thesis), Colorado State University, US, <http://digitool.library.colostate.edu/webclient/DeliveryManager?pid=122953>

Sistani, N.S. (2013), *An Investigation of Building Information Modelling Application in Design-Bid-Build Projects*, (MSc thesis), Eastern Mediterranean University, Gazimağusa, North Cyprus, <http://i-rep.emu.edu.tr:8080/jspui/bitstream/11129/598/1/Sistani.pdf>

Teicholz, P. (2013), *BIM for Facility Managers*, Hoboken, N.J.: Wiley.

Thomassen, M. (2011), *BIM and Collaboration in the AEC Industry*, (MSc thesis), University of Aalborg, Denmark, Retrieved from http://vbn.aau.dk/files/55376698/BIM_Collaboration_in_the_AEC_Industry_by_Mats_Thomassen.pdf

Underwood, J. & Isikdag, U. (2010), *Handbook of Research on Building Information Modelling and Construction Informatics: Concepts and Technologies*. Hershey, PA: Information Science Reference.

Van, J. (2008), All Things BIM, Retrieved 10 April, 2014, from <http://www.allthingsbim.com/2008/12/aia-bim-protocol-e202.html>

Velasco, A.U., (2013), *Assessment of 4D BIM applications for project management functions*, (MSc thesis), University of Cantabria, Spain, Retrieved from <http://bucserver01.unican.es/xmlui/bitstream/handle/10902/3432/A.%20Urbina%20Velasco.pdf?sequence=1>

Wang, M., (2011), *Building Information Modelling (BIM): Site-Building Interoperability Methods*, (MSc thesis), Worcester Polytechnic Institute, US. Retrieved from <https://www.wpi.edu/Pubs/ETD/Available/etd-090711-090955/unrestricted/mwang.pdf>

Wong, K. & Fan, Q. (2013), *Building Information Modelling (BIM) for Sustainable Building Design, Facilities*. 31 (3/4), 138–157. doi: 10.1108/02632771311299412.

5 BIM & Sustainable Design

5.1 Introduction

The improved awareness of energy consumption has raised concerns about several environmental impacts such as ozone layer depletion and global warming etc. Buildings' energy consumption in the UK is responsible for almost half the energy consumed by the country. It is important to validate and improve building energy performance at the early stage of design for more sustainable outcomes. Building Information Modelling (BIM) facilitates the energy performance of a building throughout the project life-cycle.

Due to the alarming growth rate of global warming, a lot of individual designers and companies are aware of the need for more energy efficient structures and these requirements are gradually being addressed around the globe. Efforts made in order to attain sustainable solutions have yet to meet their fullest potential in creating new generations of high-performance green buildings, although there have been several undertakings to reduce the use of energy and buildings' construction carbon emissions.

Sustainable solutions are important for the progression and preservation of any economy, society and/or environment. Sustainable design and construction are concerned with the improvement of the general quality of life, with waste reduction and with preservation. BIM use with the skilled project team help in achieving these sustainable solutions. This integration between a skilled project team and appropriate BIM tools brings about better quality in the design phases as well as the construction phase.

In 2016, BIM will be made mandatory by the United Kingdom government. This mandate is the government's tactic to enable all participants in the AEC industry to become more familiar with the tool and, therefore, this chapter assesses how BIM seeks to improve sustainable solutions.

This chapter provides a better understanding and a detailed breakdown of the rationale of BIM for sustainable design. The main objective is to evaluate BIM use for sustainable building design by comparing sustainable building design in theory to sustainable building design in practice.

5.2 Building design and sustainability awareness

Design and construction have always been a part of human activity. All through history, sustainability has, in one form or another, been applied to design, in spite of the fact that, centuries ago, advanced technology did not exist. In order to convey their ideas, architects and engineers put pencil or pen to paper; this process of creating drawings made project progression move quite slowly.

There is no definite time-line of when sustainability began. According to Krygiel & Nies (2008), sustainable thinking implementation is, in many ways, ancient. Buildings, designed and constructed on sustainable lines, were not only made from natural resources found in the environment but were also designed and constructed to exist within the environment. For instance, people of Canada’s central Arctic region constructed igloos made out of ice obtained from their environment (figure 5.1). These structures were built with the purpose of resisting the wind and to create thermal mass, as was the tepee (figure 5.1), built by Native Americans and fashioned from natural animal and plant materials in their region.



Figure 5.1: Igloo made from snow and Native American Tepee made from natural resources

Excellent Economics and Business programmes at:



university of groningen



“The perfect start of a successful, international career.”

CLICK HERE
to discover why both socially and academically the University of Groningen is one of the best places for a student to be

www.rug.nl/feb/education



Over time, buildings took on a different significance as civilisation grew. People were no longer designing and constructing for survival only; building designs were getting to be progressively more complex due to their new significance as designers began to design structures for different purposes other than living, for example, cathedrals, town halls and theatres, to name a few. Due to the industrial revolution, the capability to mass-produce exchangeable building materials more rapidly and economically than the material previously painstakingly produced by labourers came into existence. This discovery made construction development move faster and brought about new construction materials (which were additionally utilised as a form of trade between countries) (Krygiel & Nies, 2008).

Master builders and architects used to convey their instructions to traders on paper via hand drawn drawings until (Levy, 2012) Computer Aided Design (CAD) tools came into play. CAD made designers and engineers able to draft their drawings using computer systems which aided in the creation, modification and analysis of designs. The CAD system was used to improve design quality, to develop communication between project stakeholders through proper storage and documentation, to increase overall project efficiency, as well as in the construction of a catalogue for fabrication and manufacturing (Sarcar et al., 2008). BIM is the present-day technological acronym that has established itself in the AEC industry and has given CAD 'a run for its money'. BIM has grown into an emblem of change for participants in the AEC industry.

According to Kibert (2013), the modern day the green building movement was triggered by finding answers to two major questions. Firstly, "What is high performance green building?" This question is very important in order to have an understanding of what a green building comprises. This is vital for coalescing effort around this idea. The second question is "How do we determine if a building meets the requirements of this definition?" To answer the second question, designers have to implement a building rating system or building assessment, which makes available a detailed grading system for these innovative buildings. High-performance building projects are beginning to address three major paradigm shifts: the proximity of buildings from the energy generation sources, the challenge of climate change, and the demand for resource-efficient buildings.

Kibert (2013) stated that the initial stride taken forward in thinking and methodology first occurred in the United Kingdom with the initiation of a building assessment system known as the Building Research Establishment Environmental Assessment Method (BREEAM). BREEAM was instantly recognised by the AEC industry because it was a means of evaluating a building's performance and proposed a standard definition for a green building. BREEAM presented the first effort to successfully evaluate buildings on a widespread variety of factors that encompass not only the energy performance of a building but also the consumption of water, location, indoor environmental quality, environmental impacts, use of material, and contribution to ecological system health, to mention just a handful of the general classifications that can be incorporated into the assessment. Table 5.1 shows a list of twenty-nine of the sixty countries that have sustainable assessment bodies.

Australia	Nabers/Green Star	Mexico	LEED Mexico
Brazil	AQUA/LEED Brazil	Netherlands	BREEAM Netherlands
Canada	LEED Canada/Green Globes/Built Green Canada	New Zealand	Green Star NZ
Czech Rep	SBToolCZ	Philippines	BERDE/Philippine Green Building Council
China	GBAS	Portugal	Lider A
Finland	PromisE	Taiwan	China Green Building Network
France	HQE	Singapore	Green Mark
Germany	DGNB/CEPHEUS	South Africa	Green Star SA
Hong Kong	HKBEAM	South Korea	KGBC
India	Indian Green Building Council (IGBC)/(GRIHA)	Spain	VERDE
Indonesia	Green Building Council Indonesia	Switzerland	Minergie
Italy	LEED/Italy/protocollo Itaca/ GBCouncil Italia	United States	LEED/Living Building Challenge/ Green Globes
Japan	CASBEE	UAE	Estidama
Jordan	EDAMA	UK	BREEAM
Malaysia	GBI Malaysia		

Table 5.1: Sustainability assessment bodies in different countries (Kibert, 2013)

The famous American architect, Frank Lloyd Wright said “Study Nature, love nature, stay close to nature. It will never fail you” (Lind, 1992). We, as humans, have the intellect and technology to study nature to understand our environment, to identify what it needs and what is best for it. As time progresses, a lot more is learned concerning the future, the design, construction, challenges and operation of the built environment to meet this changing landscape of the future (Kibert, 2013).

5.3 Sustainable design

Sustainable design seeks to reduce negative impacts through environmentally sensitive design and construction practices (Autodesk, 2003). It is necessary to define what the world currently needs (such as environmentally friendly designs created with modern technology) and what the future requires from the structures being built now that are to be maintained for future use.

Sustainability is an interesting aspect of the Architectural, Engineering and Construction (AEC) industry and is part of Green Design and Construction. According to Krygiel and Nies (2008), sustainable design is seen as better than green design. This is because sustainable design takes into consideration a larger range of impacts (social impact, economic impact and environmental impact) while the term green design is used to describe designs that only have less impact on the natural environment.

The need for sustainable design and construction has become a common aim for building design in general. According to the Oxford Dictionary, the meaning of sustainability is preserving anything at a certain level or rate. McLennan (2004) explained that the dictionary meaning of the word “sustainable” or “sustainability” does not describe what a sustainable design is because, in the sustainable design domain of today, most designers want the term to mean more than just “preservation” or “maintaining”. Therefore, it means much more than a dictionary definition.

A more comprehensive definition, as cited by Krygiel and Nies (2008), is the Brundtland Commission definition which defined the paramount description of sustainable design in 1987. This definition states that sustainable development means meeting the needs of the present without compromising the ability of future generations to meet their own needs.

McLennan (2004) believes that sustainable design is the philosophical basis of a growing movement of individuals and organisations that literally seek to define how buildings should be designed, built, and operated in order to be more responsible towards the environment and responsive to people. Therefore, sustainable design is a design philosophy that seeks to maximise the quality of the built environment while minimizing or eliminating negative impact on the environment.



American online
LIGS University
is currently enrolling in the
Interactive Online **BBA, MBA, MSc,**
DBA and PhD programs:

- ▶ enroll **by September 30th, 2014** and
- ▶ **save up to 16%** on the tuition!
- ▶ pay in 10 installments / 2 years
- ▶ Interactive **Online education**
- ▶ visit www.ligsuniversity.com to find out more!

Note: LIGS University is not accredited by any nationally recognized accrediting agency listed by the US Secretary of Education. More info [here](#).



Through the 1980s and 1990s sustainable design and conservation efforts gained momentum. Over time, technology has helped to enhance design and construction processes in such a way that resources are being utilized to the fullest, time wasting is reduced, and construction sequences are becoming easy to follow via technological simulations.

5.4 Principles of sustainable design

Establishing some guiding principles is necessary to achieve the aforementioned objectives of sustainable design. As stated earlier, sustainability has different meanings to different individuals which leads to some deviations in establishing the principles for sustainable design. For example, McLennan (2004) proposed six governing sustainable design principles, these principles having respect for:

1. People – The Human Vitality Principle
2. Wisdom of Natural Systems – The Bio-mimicry Principle
3. Place – The Ecosystem Principle
4. Energy and Natural Resources – The Conservation Principle
5. Cycles to come – The Seven Generations' Principle
6. Process – The Holistic Thinking Principle

From a different perspective, *WBDG (2013)* stated that, although the definition of sustainable design is constantly evolving, six constant sustainable principles exist around the globe. These are further elaborated below.

5.4.1 Optimise/Improve a Site's Possibility

In developing a sustainable building, proper site selection must be considered firstly, alongside a contemplation of the rehabilitation or reuse of the existing structures on site. The site location, building orientation and landscape of a building affect the surrounding environment, the various means of transportation and energy usage. Whether a project is a single building, a campus, or a military base, it is important to incorporate smart growth principles into the development process.

A critical issue in enhancing the potential of a site is the location of any physical security, including access roads, vehicle barriers, parking and perimeter lighting. When retrofitting an existing building or designing a new building, the design of the overall site must be integrated with sustainable design development to achieve a successful project. A sustainable building site should also seek to reduce, regulate, and/or treat water runoffs from storms.

5.4.2 Minimise Non-renewable Energy Consumption and Enhanced Energy Usage

Concerns regarding energy independence and security are increasing due to the continuous increase in the demand for the world's fossil fuel resources and the subsequent impact on the global climate change. It is of utmost importance to increase efficiency by reducing energy load and maximising the use of renewable energy sources. Additionally, it is also important for designers to improve the energy performance of existing structures to increase human/energy independence.

5.4.3 Enhancement of Operational and Maintenance Practice

Reducing energy and resource costs, enabling higher productivity and preventing system failures are critical concerns for improved working environments. The best strategy to deal with these concerns is to consider them during the preliminary design stage. Personnel involved in building maintenance and operational management should be encouraged to take part in both the design and development phases to warrant optimal operations and maintenance of structure.

Architects and engineers can specify systems and materials that help simplify and reduce maintenance requirements such as reduced energy and water use, less toxic materials and cleaning requirements which will, in turn, lead to cost effective and decreased life span costs. Furthermore, installation of smart meters for the real time tracking and monitoring of water and energy use for increased efficiency and sustainability in buildings and neighbourhoods is another facilitating strategy to consider for the enhancement of operational and maintenance practice.

5.4.4 Indoor Environmental Quality (IEQ) Enhancement

Indoor environment quality (IEQ) has an important effect on THE comfort, health and productivity of any occupant of a building. Other significant attributes of sustainable design are a proper ventilation system and moisture control, maximized day-lighting, avoiding the use of materials with high carbon emissions and the optimized acoustic performance. This principle of IEQ emphasizes occupant control over systems such as temperature and lighting.

5.4.5 Improved Building Space and Using Environmentally Friendly Products

Materials used in any sustainable building should reduce life-cycle impacts on the environment, for instance resource depletion, human toxicity and global warming. Eco-friendly materials have a proven reduction in their effect on human health and the environment. Thus, they contribute to a reduction in liability, improved worker safety and health, reduced disposal costs, and the attainment of environmental objectives. Participants seeking to embark on a sustainable design and/or construction project should consider using fresh water efficiently and recycling or reusing water for on-site use.

5.5 Benefits of sustainable building design

To reap the full benefits of sustainable design, relevant sustainability solutions should be considered at the conceptual stage of a project and throughout the project development (*AnCor, Inc., 2011*). Such considerations should lead to a collaborative design team and an integrated design that brings better productivity for the whole lifecycle of the building. By prioritising lifecycle and environmental considerations throughout the design and construction phases, the design team can achieve all the sustainability goals laid down and agreed upon at the conceptual stage. The benefits of sustainable design and construction are valuable to the three dimensions of sustainability (social, environmental and economic) and individual or company business (*Enterprise Europe, 2010*). The benefits are explained below.

5.5.1 Environmental /Ecological Benefits

The major purpose of any sustainable building design is to preserve the environment and avoid the depletion of our ecosystem's natural resources. It enables the design team to (*AnCor Inc., 2011*):

- a) Reduce waste
- b) Reduce carbon emission
- c) Protect the environment through the reduction of greenhouse gas emissions and the preservation of various existing ecosystems



.....Alcatel-Lucent 

www.alcatel-lucent.com/careers

What if you could build your future and create the future?

One generation's transformation is the next's status quo. In the near future, people may soon think it's strange that devices ever had to be "plugged in." To obtain that status, there needs to be "The Shift".



- d) Improve air and water quality
- e) Control temperature in a building to assist in energy use reduction
- f) Preserve and restore natural resources by requiring less energy and water

5.5.2 Economic Benefits

Sustainable building design also has a number of economic benefits by the use of sustainable materials, improving water efficiency and reducing energy consumption and, subsequently, it will allow:

- a) Reduction in building operation cost
- b) Enhancement of the life cycle of a building
- c) A rise asset value
- d) Helping develop the expansion of the sustainable/green market
- e) Improvement of occupants' productivity, well-being and attendance

5.5.3 Social Benefits

The social benefits are often ignored because the economic and environmental benefits are well known. By enhancing the quality of indoor environments, designers and owners can:

- a) Improve the productivity of workers or people working/living in a building
- b) Create an aesthetically appealing environment both internally and externally
- c) Decrease pressure on local Infrastructure
- d) Increase occupants' overall morale
- e) Increase occupants' comfort and health improvement

5.5.4 Business Benefits of Sustainable Design

Sustainable design and construction oriented business methods can initially involve costs but these investment costs are probably going to generate mid and long-term cost savings and increase profitability. The potential benefits for a business include:

- a) Short and long haul cost decreases from waste and transfer costs, and expanded vitality and asset efficiencies
- b) Focal points when acquiring new work and tendering for contracts, particularly open division contracts where minimizing ecological harm is specified in the acquisition rules
- c) Better consistency with building, ecological, wellbeing and security regulations
- d) Better relations with nearby groups and media
- e) Better staff relations on the grounds that staff feel more esteemed, better encouraged and better prepared

5.6 Key challenges in sustainable design

There are some challenges that stakeholders can face in different segments of a project. Such a challenge according to Lawson (2013) is the pressure to design and construct buildings with less material, with a reduced carbon impact of materials, and with efficient water and energy use.

Collaboration can pose another challenge in achieving a good sustainable design. A design and construction team, as one entity, comprises different professionals in their respective fields. They all have different ideas and methods of working. This difference in ideas and methods of working can cause friction among stakeholders, thus causing delays in decision-making which, in turn, slows down project development.

Another challenge is inadequate knowledge of design tools recommended for use in sustainable design (Eastman, 2011). When a design team does not have adequate knowledge of the design tool to adopt for a proposed design, they are limited, in the sense that BIM is an innovative tool (Eastman, 2011). BIM tools' use requires skilled technicians to realise the full potential of the tools. Therefore, it is important that, before a contract begins, in the definition of terms and conditions, the design tool proposed must be stated. This will provide clarity amongst the stakeholders and will, over time, mean a reduction in having to convert drawings from one file format to another in order for the files to be compatible.

A 'cradle to grave' perspective refers to the value-chain that acknowledges all the parts of the design process, the construction process, utilisation and even the demolition of structures. Any energy efficiency enhancements during building occupancy could form the greater proportion of the building's life-cycle footprint.

During construction, the major challenge is waste. Hussin et al. (2013) stated that construction waste is a major issue for sustainable construction. Construction waste has a direct influence on the overall material loss, on productivity, and on the project time completion which can result in forfeiting a significant sum from the profits. Construction waste occurs due to conflicting opinions that lead to frequent changes in design, to the use of inferior materials by either the sub-contractor or as specified by the designer, to mistakes made by workers during construction processes, to poor or inadequate planning from the stakeholders and other members of staff, to weather effects, and so on.

Wong and Fan (2013) stated that the physical environment is deteriorating due to the rapid development of technology and society. Additionally, according to the Department of Communities and Local Government, UK (2013), surveys conducted in 2009 showed that about 43% of the UK's carbon emission was from buildings. Therefore, the UK government has required that all new homes, from 2016, mitigate, through various measures, all their carbon emissions and they have introduced a "Code for Sustainable Homes" which makes available a sole standard for the sustainable design and construction of new residential buildings. Despite the current efforts looking at and implementing sustainability studies, the deterioration of the physical environment is a vital area for intensive further study to derive environmental solutions for future generations. Therefore, it is critical to elaborate on the importance of sustainable design and construction and how BIM can help to enhance design and construction without harming the environment for the future.

Join the best at the Maastricht University School of Business and Economics!

Top master's programmes

- 33rd place Financial Times worldwide ranking: MSc International Business
- 1st place: MSc International Business
- 1st place: MSc Financial Economics
- 2nd place: MSc Management of Learning
- 2nd place: MSc Economics
- 2nd place: MSc Econometrics and Operations Research
- 2nd place: MSc Global Supply Chain Management and Change

Sources: Keuzegids Master ranking 2013; Elsevier 'Beste Studies' ranking 2012; Financial Times Global Masters in Management ranking 2012

Visit us and find out why we are the best!
Master's Open Day: 22 February 2014

Maastricht University is the best specialist university in the Netherlands (Elsevier)

www.mastersopenday.nl



5.7 How BIM contributes to sustainable design

This section seeks to evaluate Building Information Modelling (BIM) for design and construction by critically appraising it as a system for the enhancement of sustainability in design and construction. BIM as a technological tool seeks to improve the environment through the creation of sustainable structures. It encompasses technical and management processes to maximize time, resources and capital. Furthermore, BIM is the current technology ‘sparkle’ of the Architectural Engineering Construction (AEC) industry and can lead to a more intelligent and efficient future evolving from a more expensive inefficient past. Eastman et al. (2011) stated that BIM helps to further integrate design and construction procedures and bring about enhanced building quality at a reduced cost and with a decreased project time, when adopted appropriately.

According to the Cabinet Office (2011), BIM will become a mandate for the construction industry in the UK in 2016 since it is perceived to integrate construction participants with the design and construction processes for better outputs. This justifies looking into BIM for sustainable design and construction as it allows architects and engineers to produce a virtual building models and prototypes for tests and simulations during design in order to optimize the structures’ behaviour in the physical environment and to define the best possible design alternatives.

Levy (2012) described BIM as a design methodology squarely aimed at architects and designers. He addressed design as a parametric process and a dialectic and forensic method by which a project team collaboratively exchanges ideas to arrive at a common goal. Design as a forensic process means scientific tests or techniques used in the investigation of how a structure will behave in its environment.

The BIM Task Group (2013) articulated BIM as a value-generating collaboration throughout the lifecycle of a facility, underpinned by the design, organisation and exchange of shared 3D models and intelligence with well-thought-out data attached to them. Truly, BIM can be best described as “virtual construction”, that is, it is rich in information in terms of design, endorsement, construction and life-span maintenance. It is analytical and quantifiable, making it very precise when it comes to modelling accuracy, scheduling and quantity take off. It is also a process of collaborative working.

As design methods have been transformed over the years, so have construction methods. This is because buildings are becoming more complex than they used to be. They have more integrated and interrelated systems because of the complexities involved. Thus, BIM has become important because of the need to streamline a building’s documentation and design processes, to make simpler designs and easier construction management, and to give the client inherently better potential for continuous facility management throughout the lifecycle of a building (Moakher & Pimplikar, 2012).

5.7.1 Energy Analysis with BIM

From Moakher & Pimplikar's (2012) perspective, the application of BIM in the field of sustainability can be advantageous. BIM makes it possible for to obtain an energy analysis via different software depending on the type of analysis that is required. This particular aspect of BIM in the field of sustainability is of ecological importance.

The Building Energy software directory provides a detailed list of a widespread range of tools used for different analyses linked to the specific design of components or systems in a building (US Department of Energy, 2011).

5.7.2 Building Massing

BIM allows a designer to explore different building forms (masses) via a virtual environment that is created to mimic the real environment where the building is to be constructed (Krygiel & Nies, 2008). This system gives designers the ability to design alternative building shapes, using the same space, and to test the performances of the design alternatives before a final decision is made. Culture, climate, and location have various effects on building massing as these factors can influence the potentials for the sustainable design outcomes.

5.7.3 Proper Building Orientation before Construction

Building orientation in sustainable design is about the positioning of a building on site in accordance with the sun. How a building how the building's aspects face the sun and how the coating openings are characterized can have an impact on the vitality productivity of the building's framework and the comfort of the users. At the predesign stage, building orientation can be best specified with BIM authoring tools such as Revit that can assist in solar and shadow analysis and simulations in order to decide on the best building orientation to keep the energy loads low.

5.7.4 Day lighting Suggestions

Daylighting is strategic in diminishing the need for brightening inside building spaces and thus, subsequently, reducing the energy usag required for lighting. A very good operational day lighting configuration depends on proper building massing, orientation, and the envelope plan. The correct combination of these aspects in a building design helps designers to optimise a building's utilization of regular assets and minimize user reliance on artificial lighting (Krygiel & Nies, 2008).

5.7.5 Construction Sequence Simulation

BIM allows a project team to check their virtual models for clashes, to simulate construction sequences and to test them to figure out if they are realistic or not in order to generate alternatives during the preconstruction stage (Eastman, 2011). Such checking would subsequently help in the design stage in reducing waste, materials, and labour (and thus help avoid re-works, extra costs and disputes during the actual construction stage). Therefore, clash detection is very important in BIM. There are several models designed by each discipline such as architectural BIM, electrical BIM, HVAC BIM, and these models are integrated into a composite master model in the supply chain for checking any clashes between them. The two popular model checker or model integrating tools utilised by the AEC industry are Naviswork and Solibri tools.

While Navisworks is a project reviewing and analysis tool that is usually used for quantity take offs, clash detection, and construction sequence simulation (Autodesk, 2014), Solibri (designed by Graphisoft) is a model checker tool used to analyse structural and architectural plans for trustworthiness, quality and physical security. Solibri Model Checker incorporates practicality for data take-out, dissecting and concentrating the data accessible in BIM models. Solibri Model Checker targets zero configuration blunders, preparing expense funds in development ventures through viable demonstrations and quality confirmation. With a solitary mouse click, it is possible to examine the displayed building data, uncover potential imperfections and shortcomings in the outline, highlight the crashing segments and check that the model is in line with BIM requirements (Graphisoft, 2014).



> Apply now

REDEFINE YOUR FUTURE
**AXA GLOBAL GRADUATE
PROGRAM 2015**

redefining / standards 

agence.cdg © Photomistop



5.7.6 Project Finance Evaluation

BIM in construction projects, for example, Beck Technology Dprofiler and Carlson (CVE), can be utilized for financial evaluations such as expense evaluating and wage anticipating of venture substantive attainability in the arrangement stages. However, there is an absence of BIM devices to assist in (i) fulfilling the client's business requirements, (ii) recognizing potential answers in possibility studies, and (iii) in design venture credibility prerequisites.

5.7.7 Improved Life-cycle/Facility Management

Most individuals or organisations spend a large amount of their investment on maintaining their property. BIM tools can be used to test a building's performance before it is constructed to analyse how it will actually function when constructed. This process helps the client save resources such as time and capital. From a designer's point of view, it helps save time in terms of lean efficiency gains. The important benefits comprise:

- A better understanding of current needs and options through rapid space and energy assessment
- Improved communication of requirements and project options/intent
- Reduced expenses and time in project developments
- Superior conveyance of as-built information
- Easier contribution of new facility/asset information into cost analysing Facility Management systems
- Reduced maintenance and other running expenses
- More precise and prior expense estimation
- Waste reduction

BIM is an important and noteworthy tool that helps in reducing the environmental damage a building may cause after its construction and during its lifecycle, such as waste reduction in energy and resources, along with overall value addition. It gives the design and maintenance team the ability to carry out a Life-cycle Assessment (LCA) that allows both the design and construction teams to collaboratively evaluate the behaviour of a structure as a single entity and/or in relation to its environment throughout its existence until demolition (Krygiel and Nies, 2008).

Wong & Fan (2013) emphasized the two most important benefits of BIM use for sustainable building design which are complete design optimisation and integrated project delivery. These two benefits bring about better building design solutions, an organised method of project execution, and good relationships amongst stakeholders. Information sharing and collaboration amongst all stakeholders is important from the early design stage and brings out the most cost-effective/productive practices that any construction client can embrace.

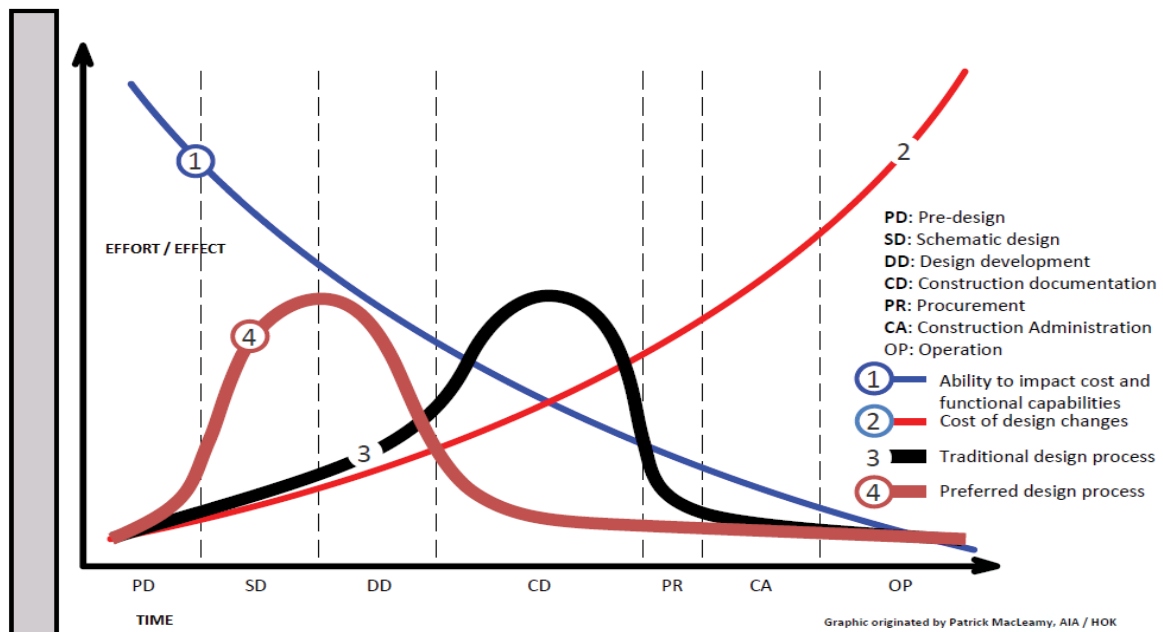

Figure 5.2: Integrated Project Delivery/Macleanny Curve (AutoDesk, 2003)

Figure 5.2 shows the shift in collaboration decisions and concentration of resources from the construction phase according to traditional design and construction to the schematic/pre-design phase of the Integrated Project Delivery method for better design and construction outputs.

The process and approach of Building Information Modelling (BIM) performs a significant role in meeting the global need for energy efficiency in buildings and sustainable construction. The process of implementing BIM is gradually increasing in the UK particularly with the 2016 Government BIM mandate about to come in. Energy performance evaluation is always possible with various simulation tools and theoretical calculations. However, it is evident that the process of optimising an energy efficient building is made easier with the assistance of the BIM process. Similarly, there are various considerations which have to be taken into account when optimising building energy performance during the design phase.

There is a need for certain design processes (integrated design team, integrated project delivery) which has to be considered when enhancing building energy performance. These processes will engage the project participants in actively taking part in developing a BIM-optimised building energy performance. The need for collaboration by the stakeholders is the key for successful implementation of BIM and energy efficient buildings. Besides assisting with legal and technical issues, BIM has proved to provide an effective combination of both modelling and analysis tools, thus assisting with the collaborative nature of work and thus providing added value.

The benefit of using BIM for optimising building energy performance during the design phase is not determined from a tool; it depends upon various processes that hold advantages for developing a successful implementation of the BIM process. However, before initiating the process of BIM at the early stage of design, a clear objective and a framework for implementation has to be established for a successful outcome.

5.8 An experimental BIM process for sustainable design

Stumpf et al. (2011) proposed an experimental process approach to conducting building energy performance within sustainable designing at the early design stage with the support of Building Information Modelling. As illustrated in figure 5.3, the process has three phases. The first phase is to clearly classify the project requirements. This may introduce challenges as, normally, projects can have constrained budgets and schedules. It is crucial that all the project participants including owners, occupants, designers, engineers and contractors have a shared clear idea of the problem definition and are involved in the identification of a set of design alternatives at the early stage of design.



Empowering People. Improving Business.

BI Norwegian Business School is one of Europe's largest business schools welcoming more than 20,000 students. Our programmes provide a stimulating and multi-cultural learning environment with an international outlook ultimately providing students with professional skills to meet the increasing needs of businesses.

BI offers four different two-year, full-time Master of Science (MSc) programmes that are taught entirely in English and have been designed to provide professional skills to meet the increasing need of businesses. The MSc programmes provide a stimulating and multi-cultural learning environment to give you the best platform to launch into your career.

- MSc in Business
- MSc in Financial Economics
- MSc in Strategic Marketing Management
- MSc in Leadership and Organisational Psychology

BI NORWEGIAN BUSINESS SCHOOL

EFMD **EQUIS** ACCREDITED

www.bi.edu/master



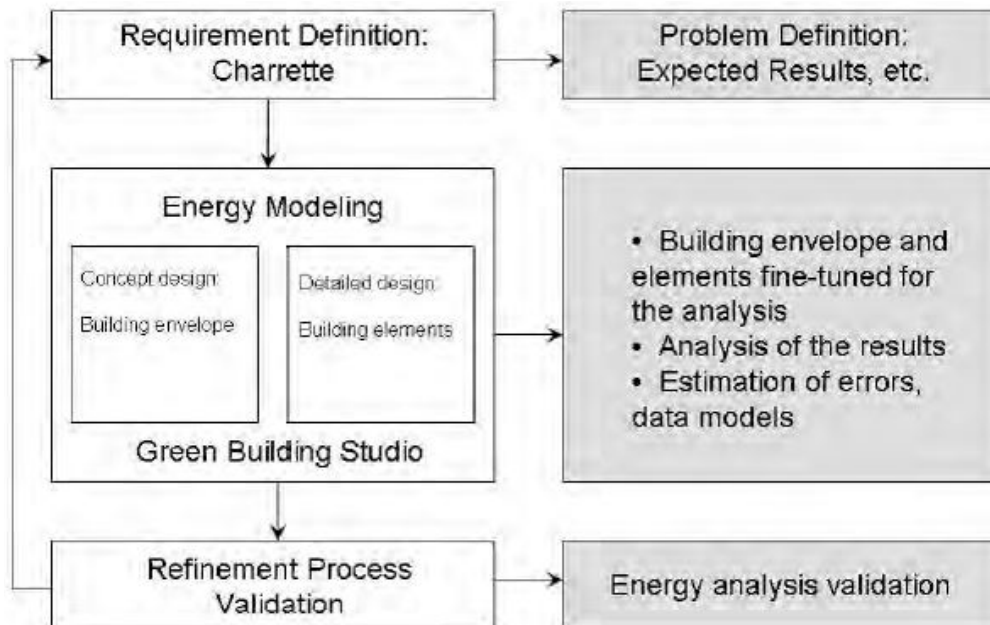

Figure 5.3: The process phases for energy analysis (Stumpf et al., 2011)

Secondly, the energy model exported from the BIM model is split into two phases, concept design and detailed design. The majority of the BIM authoring tools have almost the same approach for exporting the 3D model to a gbXML file for energy modelling. Stumpf (et al. 2011) defined that energy modelling in concept design is essential for the building envelope for the shape, orientation and lighting aspects of the design while the energy modelling in the detailed design is critical for the building elements, for size and materials used for the wall penetrations.

The third phase illustrates the refinement process which assists the fundamentals in the validation of the results from the early design energy analysis. This process of energy modelling should be repeated alongside any changes in design in case the expected results and requirements are not achieved from the proposed design alternatives.

5.8.1 Energy Simulation

Using energy simulation is an important task for the study and development of energy efficient buildings. The use of energy simulation tools is the most effective way of making decisions concerning sustainable design at the earliest stages of the design process (Ding, 2008). BIM allows multi-disciplinary information to be superimposed within a model; it establishes an opportunity for energy measures and performance analysis to be undertaken in the course of the entire design process (Azhar et al., 2009; Schueter et al., 2009). Simulation tools can provide more accurate information and more detailed analyses by giving exact values which can be translated into a more simplistic version of the BREEAM assessment namely outstanding, excellent, very good, good and pass (BREEAM, 2012). In this way, the simulations assist in predicting a building facility's energy performance at the preliminary stage of the design.

A Building Information Model (BIM) may comprise an enormous amount of information. The optimum organisation of this information is the key factor for a successful analysis of a project. Some of the important simulation tools used to monitor the energy performance of a building is given below.

5.8.1.1 Energy-10

Energy-10 is a user-friendly tool which should to be used at the early stages of design in order to avoid late construction changes (Crawley et al., 2005). This particular tool can identify cost-effective measures in minutes when the structure comprises two or more thermal zones. Energy-10 is capable of analysing both day lighting and photovoltaic systems. The designer needs to roughly define the volume of the box, the measurement of the opening, material properties, mechanical systems and the regular project scheduling. The whole design process only takes minutes to generate the results. Thus, the result provides value for the designer by providing an early insight into the energy performance of the building, yearly, monthly and even hourly. Energy-10 is best used as a preliminary design tool.

5.8.1.2 eQuest

eQuest is a relatively simple to handle energy analysis tool whereby the designer has options to either use the internal wizard or to import the model to the external application (Crawley et al., 2005). Much information is required from the designer in order to gain optimum results. The information required may include lighting properties, material properties, accurate schedules and detailed information on the mechanical system. Since the level of input required from the designer is high, the level of expertise required for using this tool is also high. This tool can be used for both preliminary design analysis and for a detailed modelling programme.

5.8.1.3 Energy Plus

Energy Plus is a complete simulation engine which models heating, cooling, lighting and ventilating. This tool is used to calculate more accurate temperature and comfort prediction. A high level of mechanical input is required from the designer. A high level of expertise is advantageous because precise details can make a significant impact on the results. Designers who attempt to use this programme will need considerable training and practice. It is more preferable to use this tool in the final stages of the design where accurate details are required.

5.8.1.4 Green Building Studio (GBS)

Green Building Studio is a comprehensive web-based energy analysis programme. It is a cloud-based energy analysis tool that assists designers in lessening the energy consumption of a building, in carrying out whole-building analysis, and in enhancing design towards carbon neutral buildings in the early stage of design development. GBS links the architectural 3D model with the energy analysis through the gbXML format. This particular energy analysis can be performed at any stage of the design. The only requirement to perform the analysis is to upload the 3D architectural model into the GBS website. Once the 3D model is uploaded, the website engine processes the data available from the model and a predetermined location is selected according to the country selected. Once the designer accepts the GBS results as valid, then those results will represent the actual building. This simulation tool is can be used at any stage of design until the model holds perfect geometry; precise results will be gained.

5.8.1.5 Ecotect

Ecotect is a sustainable energy design analysis tool created by Autodesk that offers a wide range of building energy analysis functionality and simulation in order to enhance the performance of new and existing buildings.

Need help with your dissertation?

Get in-depth feedback & advice from experts in your topic area. Find out what you can do to improve the quality of your dissertation!

Get Help Now



Go to www.helpmyassignment.co.uk for more info



Helpmyassignment



5.9 Limitations in using BIM for sustainability

The built environment is an intersection of many AEC disciplines and ICT (Information and Communication Technologies) are making advances in many areas of the construction industry. However, ICT is still under-utilised in many areas of built environment applications. More specifically, BIM use for sustainable design and construction is still in its infancy due to interoperability challenges. (Interoperability is concerned with the sharing and exchange of building data across all BIM applications and disciplines.) Interoperability issues occur when two or more BIM tools are not compliant with each other, due to different reasons such as the year in which they were released having different versions and/or different formats for saving the model (.xml or .dwg or .rvt) depending on the tool used. This makes sharing information a challenge (Eastman et al, 2011). Moreover, due to interoperability, a conflict of interest may occur between the stakeholders leading to legal and copyright issues. A team member may prefer to work in a certain file format or software version and other formats are not used, possibly due to a lack of interest, knowledge or skills.

Wang (2012) stated that BIM is limited in its collaboration and simulation aspects. BIM has no collaborative or social networking integrated into it. Social Network functions or Groupware (computer-supported collaborative work) could possibly be incorporated within BIM tools to enhance BIM's collaborative abilities. If software vendors integrated social networks such as twitter and facebook into BIM tools, it would enable the easy digital collation of people's feedback/comments through multi-disciplinary asynchronous and synchronous communication and collaboration.

5.10 Conclusion

Implementing BIM at the preliminary stage of a design is crucial to improve the overall energy performance of a building. The process begins with the conceptual design produced by the architect. Once the conceptual design is produced and modelled in BIM, energy modelling from the concept design should be carried out. Subsequently, energy analysis and simulations are conducted to check if the design meets the client requirements and expected performance values. Finally, the design is improved using the energy simulation results. Once the improvement is finished, the process iterates until the desired results are achieved.

It is broadly accepted that the different energy loads of building components can dominate each other and lead to a big collision to the entire building energy performance. Building Information Modelling (BIM) has the potential to identify the various energy loads in the building during the design phase and can also assist in improving the building energy performance. It is clear that BIM is not the only way to improve building energy efficiency; however, the implementation of BIM makes the process easier than with traditional methods.

The two main influential factors are the design consideration and the energy analysis. Design considerations are based on occupancy factor, design and climate. The analysis is executed during the design phase and criteria based on building orientation, building shape and daylight are considered. The energy analysis is divided into two analyses, namely, micro and macro energy analyses. Various criteria based on the macro-level energy analysis such as HVAC, wall and lighting are considered. In contrast, the micro-level energy analysis comprises the shape, daylighting and orientation of the building. In order to achieve an energy efficient building, it is useful to undertake an energy performance analysis early in the design stages based on the BIM process. Therefore, BIM has the potential to establish a comprehensive solution for the building energy performance better than that indicated by the baseline conceptual design. Taking on board the global awareness of energy consumption, the overall building energy performance can be significantly improved during the design stage with effective Building Information Modelling for sustainable design.

5.11 References

AnCor, Inc. (2011), The Benefits of Sustainable Building, Retrieved 31/03/14 from thedesigndesignblog.wordpress.com/2011/04/04/the-benefits-of-sustainable-building/

AutoDesk (2011), Building Information Modelling for Sustainable Design: Conceptual Building Performance Analysis Overview, Autodesk.

Azhar, S., Hein, M., Sketo B. (2009), *Building Information Modelling (BIM): Benefits, Risks and Challenges*. Auburn, Alabama: Auburn University.

BIM Task Group (2013), "Frequently asked questions-What is BIM?", Retrieved 12/03/14 from <http://www.bimtaskgroup.org/bim-faqs/>

Boswell, P. & Walker, L. (2004), Procurement and Process design. Retrieved from http://www.sb05.com/academic/15_IssuePaper.pdf

BREEAM (2012), *New Construction for Non-Domestic Buildings, Technical Manual Version SD5073 Issue 3.0*, BRE Global Ltd.

Cabinet Office, (2011), Government Construction Strategy, 10/02/14, from https://www.gov.uk/government/uploads/system/uploads/attachment_data/file/61152/Government-Construction-Strategy_0.pdf

Crawley, B.D., Hand, J.W., Kummert, M, Griffith. B.T., (2005), *Contrasting the capabilities of building energy performance simulation programs*, Proceedings of the Ninth International Conference of the International Building Performance Simulation (IBPSA), Montreal, Canada.

Department for Communities and Local Government, (2013), Improving the Energy Efficiency of Buildings and Using Planning to Protect the Environment, 12/02/14 from <https://www.gov.uk/government/policies/improving-the-energy-efficiency-of-buildings-and-using-planning-to-protect-the-environment>

Ding, G.K. (2008), *Sustainable construction – The role of environmental assessment tools*. Journal of Environmental Management.

Eastman C., Teicholz, P., Sacks, R., Liston K., (2011), *BIM Handbook: A Guide to Building Information Modelling for Owners, Managers, Designers*, (2nd ed.), US, Wiley Publishing.

Enterprise Europe, (2010), Sustainable Construction, Retrieved from http://www.internationaltenders.eu/en/choose_country/united_kingdom/sustainable_construction_uk.htm

Graphisoft, (2014), Partner Solutions, Retrieved 02 April, 2014, from http://www.graphisoft.com/archicad/partner_solutions/solibri_model_checker/

Hussin, J.M., Rahman, I.A. & Memon, A.H. (2013), “The Way Forward in Sustainable Construction: Issues and Challenges, *International Journal of Advances in Applied Sciences (IJAAS)*, 2 (1), pp 31–42.

Brain power

By 2020, wind could provide one-tenth of our planet's electricity needs. Already today, SKF's innovative know-how is crucial to running a large proportion of the world's wind turbines.

Up to 25 % of the generating costs relate to maintenance. These can be reduced dramatically thanks to our systems for on-line condition monitoring and automatic lubrication. We help make it more economical to create cleaner, cheaper energy out of thin air.

By sharing our experience, expertise, and creativity, industries can boost performance beyond expectations. Therefore we need the best employees who can meet this challenge!

The Power of Knowledge Engineering

Plug into The Power of Knowledge Engineering.
Visit us at www.skf.com/knowledge

SKF



Kibert, C.J. (2013), *Sustainable Construction-Building Design and Delivery*, (3rd ed.), New Jersey: John Wiley & Sons, Inc.

Krygiel E. & Nies B. (2008), *Green BIM-Successful Sustainable Design with Building Information Modeling*, Indian Wiley Publishing, Inc.

Lawson, R. (2013), "The importance of construction sector to the overall economy. Retrieved 13 March, 2014, from <http://www.walesbusiness.org/2013/08/the-importance-of-construction-sector-to-the-overall-economy/>

Levy, F. (2012), *BIM in small scale Sustainable Design*. Canada: Wiley & Sons, Inc.

Lind, C. (1992), *Wright Style*, Singapore: Simon & Schuster, Inc.

McLennan, J.F. (2004), *the Philosophy of Sustainable Design*, Missouri, Ecotone LLC.

Moaker, P.E. & Pimplikar, S.S. (2012), Building information modelling (BIM) and Sustainability-Using Design Technology in Energy Efficient Modelling, *Journal of Mechanical and Civil Engineering*, 1(2), pp. 10–12.

Sarcar, M.M.M., Mallikarjuna Rao, K., & Lalit Narayan, K. (2008), *Computer Aided Design and Manufacturing*, New Delhi: Prentice-Hall of India Private Limited.

Schlueter, A. and Thesseling, F., (2009), *Building information model based energy/exergy performance assessment in early design stages*, *Automation in Construction*.

Seager, A. (2007), *Construction sector rises to challenge of building eco-friendly homes of the future*, www.theguardian.com/business/2007/feb/28/communities.society

US Department of Energy, (2011), Building Energy Tools Software Directory, 01/04/14
<http://www.buildingenergysoftwaretools.com/>

Walayat, N. (2010), The Market Oracle: UK Population Growth and Immigration Trend Forecast 2010 to 2030. Retrieved 10 March, 2014, from <http://www.marketoracle.co.uk/Article21565.html>

Wang, X. (2012), Book Review-BIM Handbook: A Guide to Building Information Modelling for Owners, Managers, Designers, Engineers and Contractors. *Australian Journal of Construction Economics and Building*, 12 (3) pp 101–102.

World Building Design Guide (WBDG) Sustainable Committee, (2013), Sustainable, Retrieved 14 March, 2014, from <http://www.wbdg.org/design/sustainable.php>

Wong, K. & Fan, Q. (2013), Building information modelling (BIM) for sustainable building design, *Journal of Facilities*, 31(3/4), pp. 138–157. Doi:[10.1108/02632771311299412](https://doi.org/10.1108/02632771311299412)



"I studied English for 16 years but...
...I finally learned to speak it in just six lessons"
Jane, Chinese architect

ENGLISH OUT THERE

Click to hear me talking before and after my unique course download



6 BIM and Construction Management

6.1 Introduction

This chapter explains the use of Building Information Modelling within Construction Management Practice on-site. It focuses on the roles and responsibilities of the construction management team within the actual construction stage of projects. The barriers faced by the construction management team are elaborated. The chapter analyses how the use of BIM can provide help to overcome those challenges.

In 1998, Sir John Egan and his Construction Task Force were commissioned to produce a report for improving the quality and efficiency of UK Construction by the then Deputy Prime Minister, John Prescott. The report clearly defined that ‘there is no doubt that substantial improvements in quality and efficiency are possible’ throughout UK Construction. In the report by Sir John Egan (1998) entitled ‘Re-thinking Construction’, the Task Force detailed that technology, as a tool, could provide assistance in improving efficiency and quality in construction.

The report by Egan (1998) stated that “one area we know new technology to be very useful is in the design of buildings and in the exchange of design information throughout the construction team”. Egan (1998) also expressed that there are enormous benefits to be gained in terms of eliminating waste and rework, for example, by using modern CAD technology to prototype buildings and by rapidly exchanging information on design changes. Re-design should take place on a computer, not on the construction site (Egan, 1998).

Following the Egan report (1998), the Government Cabinet Office produced the ‘Construction Strategy’ in May 2011. The Government’s plan for growth highlighted the critical importance of an efficient construction industry to the economy (as it is a major part of the UK economy representing over £110bn per annum). The report provides numerous instances as to how BIM can improve the efficiency of government construction projects (a subject which will be further discussed in this chapter). The strategy report stated that the Government would mandate fully collaborative 3D BIM for all project and asset information documentation by 2016 for all public property projects. Following the report, the UK Government commissioned the BIM Task Group to lead and promote collaborative BIM implementation in the construction industry, together with the responsibility for the delivery of strategies for the BIM implementation requirements.

6.2 Background – construction project management

The success of any construction project depends largely on how well the construction project has been planned, organised and controlled. Planning and organisation are essential throughout the life of the construction project from the initial design and briefing stage to the completion of the construction phase (Topliss, 2007).

Construction management is the overall planning, co-ordination and control of a project from beginning to completion. The responsibility for the management and delivery of a construction project is traditionally assigned to a construction contractor by the client or by the client’s project manager as the representative.

The principal contractor is appointed to start work on the construction project at various points of the project timeline, for example, a construction contractor can be appointed early in the project when the initial design is drafted under a design and build contract or at a later stage when the full project design is completed under a traditional construction contract. Construction contractors are traditionally selected by the client’s representatives through the tender/bidding process.

When the principal contractor is selected by the client, the construction project management team can be defined. The responsibility for the delivery of the project on time and cost, with safety and to the correct quality is given to the construction team. Figure 6.1, shown below, depicts a typical construction project management team that would be implemented by a principal contractor to deliver a construction project.

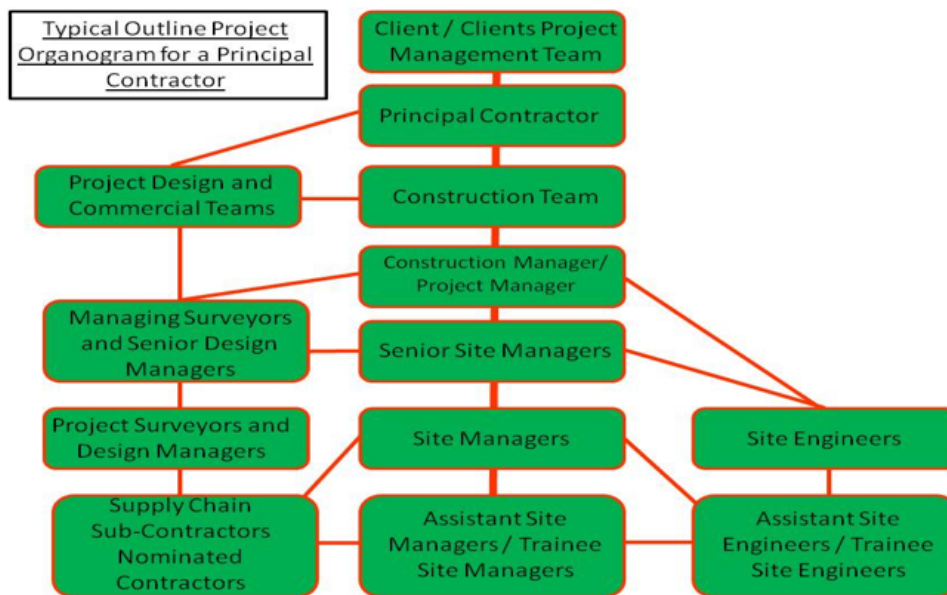

Figure 6.1: Hierarchical representation of a Construction Project Management team on-site

6.2.1 The Responsibilities of the Construction Management Team

The organogram in figure 6.1 shows that the construction management team provides a vital collaborative link to all the parties involved in a construction project. The construction management team made up of construction managers, project managers, site managers and site engineers who provide collaborative links between the many parties involved such as the design team, commercial teams, client teams and external bodies, for on-site productivity.

Figure 6.2 shows a concept map that highlights the individual bodies that provide and receive information from the site construction management team. It is the responsibility of the team to ensure that such information is used during the construction of the project.



What do you want to do?

No matter what you want out of your future career, an employer with a broad range of operations in a load of countries will always be the ticket. Working within the Volvo Group means more than 100,000 friends and colleagues in more than 185 countries all over the world. We offer graduates great career opportunities – check out the Career section at our web site www.volvogroup.com. We look forward to getting to know you!

VOLVO
AB Volvo (publ)
www.volvogroup.com

VOLVO TRUCKS | RENAULT TRUCKS | MACK TRUCKS | VOLVO BUSES | VOLVO CONSTRUCTION EQUIPMENT | VOLVO PENTA | VOLVO AERO | VOLVO IT
VOLVO FINANCIAL SERVICES | VOLVO 3P | VOLVO POWERTRAIN | VOLVO PARTS | VOLVO TECHNOLOGY | VOLVO LOGISTICS | BUSINESS AREA ASIA

Download free eBooks at bookboon.com



Click on the ad to read more

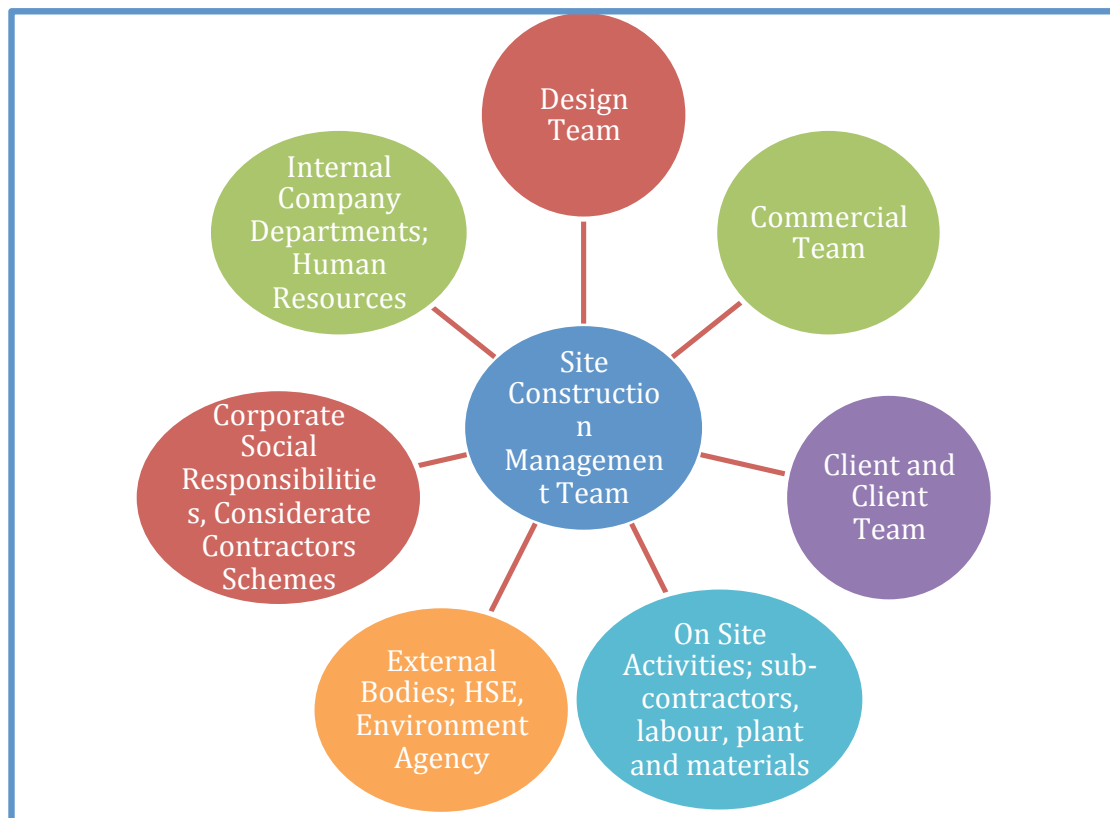

Figure 6.2: The relationship between construction management team and the other parties in terms of information sending and receiving.

The concept map in figure 6.2 highlights the different project stakeholders and departments liaising with the construction management team. The construction management team must utilise the information provided by each body and provide them with required information.

6.2.2 Key Roles and Responsibilities and the Related Challenges Faced

The key responsibilities of the construction management team are to deliver the project in a timely, cost efficient, safe and effective manner. This is a must in order to ensure end user satisfaction from the project. Therefore, construction management addresses the effective planning, organising, application, coordination, monitoring, control and reporting of the core business processes for an organisation engaged in the provision of construction facilities (Harris, 2013). The function of the construction management team is to bring a project or series of projects to safe completion, on time, to budget, to the set quality and expected innovative, aesthetic, and socially responsible outcome and with good environmental impact (Harris, 2013). These responsibilities are further elaborated below together with their associated challenges.

6.2.2.1 Project Planning and Challenges

The collaborative site construction management team and the project planner are responsible for the development of the construction project programme. The project planner must provide staged programmes and report upon the progress of all aspects of design, procurement and construction activities. The project planner has the responsibility for reviewing and assessing the impact of client changes and sub-contractor delays upon the project programme. Project countdown programmes are prepared collaboratively by the site management team to assist in the delivery of the project on time to the required completion date for the project.

However, there are challenges in the project planning undertaken by the site management team. Subbiah (2012) stated that construction planning is one of the major factors influencing the success of a construction project, but that there is scant examination of the factors that influence the success of construction project planning. Laufer and Tucker (1988) stated that specialist planners have the time to undertake such work and have good strategic decision-making skills but they have incomplete practical knowledge, limited detailed information available and also lack a final decision-making authority. Conversely, construction managers may have improved practical knowledge and possess the decision-making authority, but lack the time to plan.

Johansen (1996) stated that construction managers often ignore the formal project master programme and instead adopt their own flexible approach to planning. Further, Winter & Johnson (2000) confirmed that most contractors' programmes do not have the necessary links, are not resource driven and, on the whole, are not prepared to reflect what will actually happen on site, but are designed to win the job for the contractor. Faniran (et al. 1999) also highlighted that poor performance was the result of both too little and too much planning, where uncertainty and over-control were evident in the planning. On the other hand, Johansen & Porter (2003) highlighted the need for (i) improved sub-contractor planning competence, (ii) an increase in planning input, and (iii) closer involvement in the planning processes.

These aforementioned issues which occur in the construction planning process reflect that more co-ordination and collaboration is critically necessary for the project stakeholders such as the planners, construction managers and sub-contractors. With all factors considered, all project stakeholders would benefit by working together to strategically plan the project as opposed to all working to individual project plans and individual opinion driven construction methods.

6.2.2.2 Organisation, Co-ordination and Challenges

The construction site management team are responsible for the logistical management of a site on a day-to-day basis. This includes assuming responsibility for the detailed construction process, ensuring that all work is carried out as planned and that the construction, and relevant, regulations are observed at all times. The management team must ensure that the site is properly supervised at all times throughout the construction process and that adequate labour resource is allocated to the project to ensure the timely delivery of the project.

The connection between client's design team and the CDM (Construction, Design and Management) co-ordinator is also the responsibility of the construction management team on site which must advise the design team of buildability issues when possible in order to foresee construction clashes, speed of construction and any potential project cost savings.

The project design manager must co-ordinate all the design disciplines and the sub-contractors to ensure the integration of the design procurement and construction functions. It is the role of the site-based design manager to engage with the site managers on construction projects to ensure the management and control of all design information.



The advertisement features a runner in a red top and black leggings running on a dirt path. The background is a warm, golden-orange glow. The GaiTEYE logo is in the top left, with the tagline 'Challenge the way we run'. Below the logo, the text reads 'EXPERIENCE THE POWER OF FULL ENGAGEMENT...'. Further down, it says 'RUN FASTER. RUN LONGER.. RUN EASIER...'. In the bottom right, there is a yellow button with the text 'READ MORE & PRE-ORDER TODAY' and 'WWW.GAITEYE.COM', accompanied by a hand cursor icon. Technical diagrams, including a circle with a crosshair and a line with a perpendicular symbol, are overlaid on the runner's feet.



The co-ordination between the direct labour resources, the sub-contract labour resources and individual work packages is the responsibility of the construction management team. The site management team must liaise with the project design team when design clashes become apparent during the construction phase.

It is common practice for a main contractor to sub-let most of their work (Ng and Price, 2005). There are many factors that affect project performance with sub-contractors' performance being one of the most critical factors. A survey has been undertaken to identify the key success factors affecting the performance of sub-contractors in building construction projects in Hong Kong. The survey showed that the main contractors' site co-ordination was the most important success factor with regard to sub-contractors during the construction stage (Ng and Price, 2005).

From this study, it was found that the performance of sub-contractors increasingly affects the outcome of many building projects. However, most sub-contractors in the study complained that they are unable to efficiently and effectively perform their site work due to main contractors' poor site co-ordination (Ng and Price, 2005).

Examples of poor co-ordination (as provided by the sub-contractors) included inadequate or insufficient construction information, inaccurate interfacing works between different sub-contractors, impractical working sequences, a lack of construction information provision, late responses to site problems (such as design clashes) and the working programme not providing enough detail (Ng and Price, 2005).

Feedback from sub-contractors which provide services for principal contractors indicates that a collaborative project-based information system would be beneficial. This would provide additional interaction between the principal contractor and the sub-contractors working on the same project.

6.2.2.3 Implementation of Project Information and Challenges

A project's site management team needs to implement the latest design information provided by the design team. Company policies and procedures must be implemented, such as the project management plan and the project design management plan. The project site team must implement and adhere to the latest statutory Health and Safety laws defined by the Health and Safety Executive.

The delivery process for AEC design information remains fragmented and it depends on paper-based modes of communication (Eastman et al., 2011). Errors and omissions in paper documents often cause unanticipated field costs, delays and, sometimes, lawsuits between the various parties in a project team thus causing friction, financial expense and delays to the project.

The issue of the communication of design information between the design team and construction team is not a recent phenomenon. Bennett (1985) stated that, during the construction process, builders face several problems; some of these problems are complicated, difficult to understand and thus impact on the building process. Too much time and effort is spent trying to understand the design intent and making it work, which means that design teams have to wait for the site management team to explain how it could be done.

These issues have been discussed many times in the literature and visualisation and IT-based communication could improve the collaboration between site and design teams in resolving the buildability problems that may potentially occur during actual construction.

Eastman et al. (2011) proposed alternative organizational structures such as the design-build method, and the use of real-time technology (such as project websites) for sharing plans and documents to address such communication problems. Although these methods have improved the timely exchange of information, they are limited in their ability to reduce the severity and frequency of conflicts caused by paper documents or their electronic equivalents. This is due to insufficient use of the information and the associated difficulties in the production of the information. Therefore, a collaborative central information system would be beneficial for all parties. This would allow all stakeholders involved in the project design, construction and delivery to access the latest project information, although this would not solve the issue of design conflict solely.

6.2.2.4 Monitoring the Construction Process and Challenges

The site management team is also responsible for the monitoring of health, safety and environmental matters within a construction project. Project progress must be monitored and recorded by the site management team and the information provided by the client which has relevance to the on-site workforce should be communicated amongst the project team as a whole. Quality assurance checks should also be completed by the site management team to ensure that the work produced on-site is compliant with the project's specifications, the design drawings and national standards.

Commercial awareness and monitoring is an essential role carried out by the construction site management team. Issues such as additional costs caused by such matters as missing design information, overspent resources and missing project tasks in sub-contractors' work packages need to be identified. Additional work that is to be carried out by the contractor on behalf of the client should also be identified in order to allow the contractor's commercial team to recover additional costs. If the site management team is commercially aware, the contractor can run a more efficient and profitable organisation.

Reliance on paper-based work plans such as site diaries compiled by the site management team also causes challenges in the monitoring of the construction process (paper-based quality management systems are commonplace on sites within UK construction projects).

There have been countless official and semi-official reviews, investigations and reports on the performance of the construction industry over the past 100 years or so, and almost all of them have pointed to the poor standards of information management as being, in one way or another, instrumental in the industry's under-performance. Even though most of these reviews and reports have suggested fixes (largely organisational or contractual in nature) none have been able to offer a real solution. Until now, there has been very little that the industry could do or has done about these issues but, with Building Information Modelling, things may be about to change (Crotty, 2012).

6.3 BIM as a Way Forward for Better Construction Management

Building Information Modelling is regarded as the process of generating and managing data about a building during its lifecycle. Typically BIM uses three-dimensional, real-time, dynamic building modelling software to increase productivity in the design and construction stages. Building Information Modelling covers geometry, spatial relationships, light analysis, geographic information, and the quantities and properties of building components (Smith, 2012). Most information used in a construction project has, in the past originated from 2D architectural CAD drawings which are notoriously poor containers or conveyors of information. Such drawings must be constantly checked to ensure that they provide clear, consistent, co-ordinated and correct information (Crotty, 2012). However, BIM can improve dramatically the inherent quality of building design information and the mechanisms/procedures by which information is communicated and shared amongst members of the project team (Crotty, 2012).



BIM embraces a strong approach for enhancing collaboration between stakeholders using ICT to exchange valuable information throughout a project's lifecycle. Such collaboration is seen as the answer to the fragmentation that exists within the building industry, which has caused various inefficiencies (Arayici et al., 2012). Although BIM is not the salvation of the construction industry, much effort, via BIM, has gone into addressing issues that have remained unattended for far too long (Jordani, 2008). For example, with BIM based design techniques and methods for communication between stakeholders, design and communication problems can be resolved as BIM models generate dramatically higher quality information than the conventional drawing based techniques (Crotty, 2012).

An overview of how BIM can assist with the problems currently being encountered by construction management teams on construction projects is discussed below.

6.3.1 The Use of 3D Modelling Techniques

3D BIM modelling assists in the management of construction operations with simply the use of the graphical power of the 3D model as a means of visualising how the building fits together. The designer develops a computerised 3D model of the proposed building design via BIM which provides a number of key benefits when compared to conventional 2D CAD drawings (Crotty, 2012), for example:

1. Explicit representation of the objects being designed.
2. Inherent co-ordination of details between different views of the same component.
3. Direct, unambiguous association of many different types of data with selected components, resulting in extremely data-rich models.
4. Easily generated 3D views, complex section views, rotations and walk-throughs etc. to enable complex objects to be designed efficiently and understood intuitively.
5. The flow of information between the design team and the contractors can easily be organised so as to be timely and smoothly flowing.

The image in figure 6.3 shows a 3D BIM model for a design and construction project.



Figure 6.3: A 3D BIM model for a London based construction project

6.3.2 BIM Use for Clash Detection

Clash detection was termed as buildability or constructability in the past and refers to the clashes that occur on a construction site. For example, a beam designed by a structural engineer is right in the path of some air conditioning units that have been located by the MEP engineer). Realising the presence of these clashes on a construction site leads to waste, huge expense, costly delays and, subsequently, to dissatisfaction, and to legal disputes on some occasions. Therefore, it is important to discover and fix potential clashes at the design stage in order to avoid such undesirable circumstances on construction sites.

The ability of BIM tools to carry out clash detection and to simulate construction exercises provides significant assistance in the management of construction operations. BIM modelling co-ordinates elements of design to ensure that different building systems do not clash and can actually be constructed in a defined space; subsequently, it enables the identification of potential problems early in the design phase so that they can be resolved before construction begins. Thus, it helps to generate value in the savings made through the elimination of waste due to realisation of any clashes identified by BIM on the actual construction site.

Clash detection comprises the identification of three types of clashes. These are hard clashes, soft/clearance clashes, and 4D workflow clashes. An example of a hard clash is simply given by two objects occupying the same space such as a pipe going through a wall where there is no opening. Soft clashes refer to allowable tolerances or space, for instance, buffer zones between components which are left to provide space for future maintenance. Finally, 4D Workflow clashes are the type of clashes which can occur in scheduling work crews. Equipment/material fabrication delivery clashes and other timeline issues are other examples of this type of clash.

In BIM based design practice, clash detection practice can take place during the design review phase so that constructability issues can be resolved before construction begins, saving vast sums of money and amounts of time and producing a better building.

Figure 6.4 shows an image of a 3D BIM model of a hospital project that is to be constructed. The area in red details a clash that has been highlighted by using a BIM tool such as Navisworks in the 3D BIM environment. Figure 6.5 is the enlarged image of the highlighted clash shown in figure 6.4. This image shows that two structural elements are clashing as they are located in the same spatial area within the 3D model.



www.sylvania.com

We do not reinvent the wheel we reinvent light.

Fascinating lighting offers an infinite spectrum of possibilities: Innovative technologies and new markets provide both opportunities and challenges. An environment in which your expertise is in high demand. Enjoy the supportive working atmosphere within our global group and benefit from international career paths. Implement sustainable ideas in close cooperation with other specialists and contribute to influencing our future. Come and join us in reinventing light every day.

Light is OSRAM

OSRAM SYLVANIA



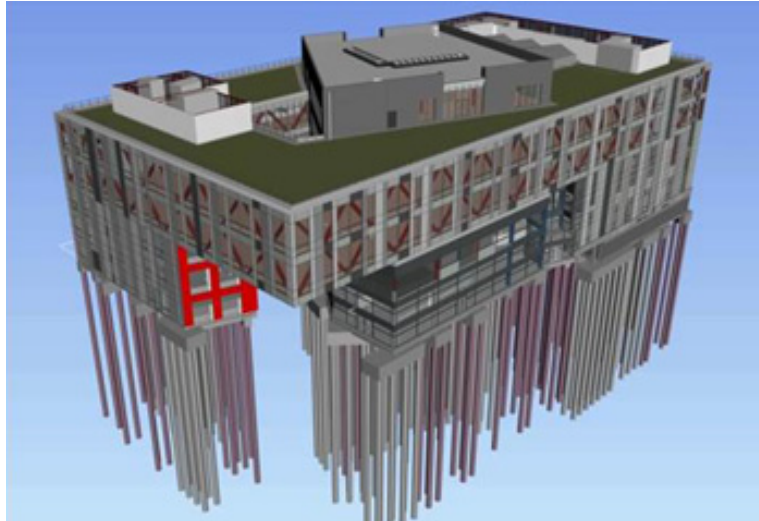

Figure 6.4: A 3D BIM Model with Detected Clash



Figure 6.5: Detailed view of the detected clash between the steelwork elements

Without the use of BIM modeling and clash detection tools and methods, this issue would not have been discovered until those components had been in the process of construction on-site.

6.3.3 The Use of 4D BIM in the Planning and Logistics Process

BIM based project delivery methods continue to take hold in the construction industry; an intriguing and sophisticated modeling technique is beginning to emerge. It is often referred to as 4D BIM or Simulation-Based Modeling and relies on integrating components of the 3D BIM with time or schedule-related information (Jacobi, 2011).

4D BIM enables one to visualize the entire duration of a series of events. The 4D models expand upon the value of the traditional 3D models developed during the design process, together with a project's scheduling system, to improve understanding and collaboration for all project participants.

Some of the key benefits associated with 4D BIM include improving site planning by enabling “what-if” scenarios to test and improve different schemes. Simulations of installation conflicts, design clashes, and work flow management can be performed before work begins. Construction sequences can be simulated to facilitate quick and effective decision-making by the contractor, sub-contractors, design team and client (Jacobi, 2011). In addition, temporary activities and structures like scaffolding and tower cranes should also be included in the building model for effective and efficient site planning (Eastman et al., 2011).

Eastman et al. (2011) also stated that a contractor's knowledge is crucially significant when building a 4D model for the planning process. If a model is built during the design phase of a building, then the contractor can provide valuable feedback about constructability, estimated construction cost and sequencing. 4D BIM simulations which aid the planning process act as a communication tool for identifying potential bottlenecks and as a method to improve collaboration amongst project teams.

4D BIM also assists in the management of sub-contractors during the construction process, that is to say, it enables contractors to identify when and where subcontractors are likely to be working and allow them to alter the sequencing to avoid overlapping trades, thus minimizing delays and health and safety risks (Smith, 2012).

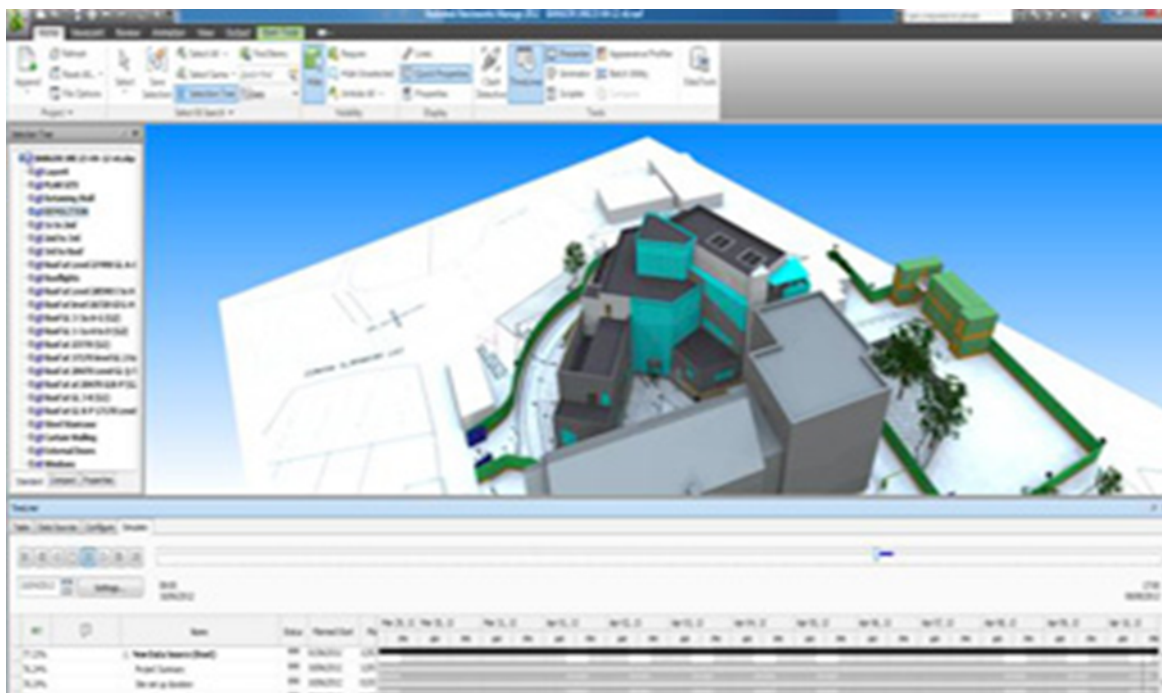

Figure 6.6: An example of 4D BIM Planning and Scheduling (Eastman et al., 2011)

Figure 6.6 shows an example of a 3D BIM model being utilized to create a 4D BIM model using tools such as Autodesk Revit and Autodesk Naviswork tools. The programmed task durations and project workflow are added to the model to assist with the management of the construction process.

6.3.4 Project Information and Project Monitoring with Mobile BIM

Mobile BIM technologies provide real-time construction project information and a continuous project monitoring ability for the construction management team. It further helps in managing quality, safety and commissioning on projects remotely. Visual aids accelerate field communication by taking job site photos, marking up and attaching them to locations with pushpins. For example, BIM 360 provides abilities and functionalities when using mobile tablet devices on construction projects. BIM 360 is a BIM tool for construction collaboration and management. It is a cloud based tool that combines cloud and mobile technologies to collect, connect, visualize and manage design and construction data in order to improve construction collaboration, prevent issues and drive higher quality and profitability.



360°
thinking.

Deloitte.

Discover the truth at www.deloitte.ca/careers

© Deloitte & Touche LLP and affiliated entities.



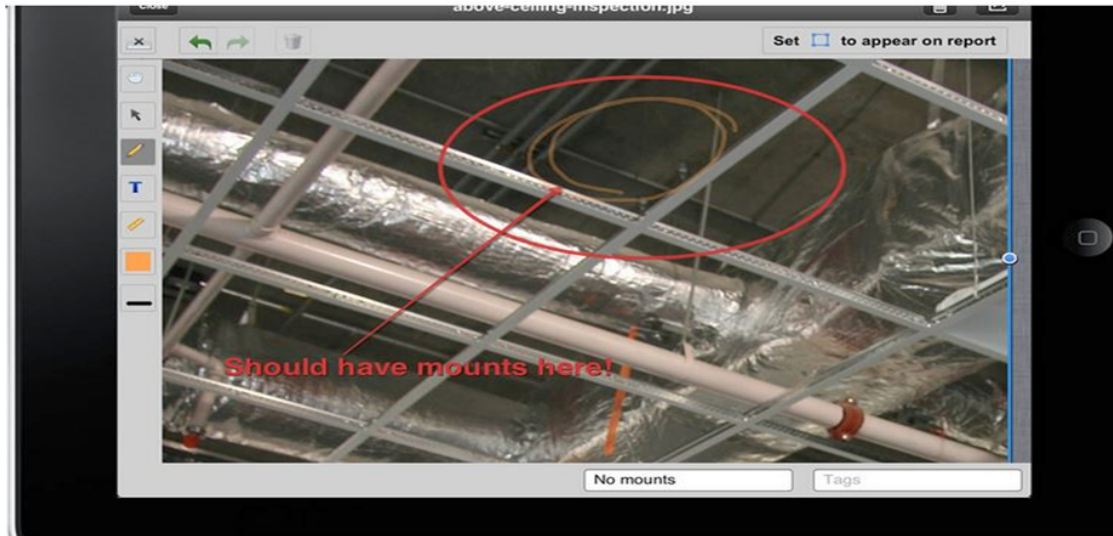

Figure 6.7: A tablet computer system displaying a quality inspection carried out to high level services

Interactive up-to-date project information can be used at the workplace. Quality and safety management benefits are also available through quality checklists' functions.

6.4 Conclusion

It is worthwhile mapping the benefits and advantages of using BIM technologies in overcoming the barriers impeding construction management. According to research that has been undertaken and best practice case study findings, it is proven that BIM has capabilities to address CM barriers. Figure 6.8 shows the match between those barriers and BIM tools and methods. Further information on how such CM barriers are tackled in real projects is explained in the case studies' chapter (chapter 9) where detailed demonstrations of BIM use by construction management teams are presented as well as an extensive discussion of BIM capabilities by presenting additional areas of BIM use such as such as the M+E handover of walls and detailing of partresses within partition walls.

During a focus group discussion with practitioners (who were involved in the case study projects explained in chapter 9) identified BIM challenges/barriers and corresponding BIM tools and methods were confirmed.

With the case studies in chapter 10 in mind, it is proven that BIM can provide benefits within construction projects and assistance for construction management teams. However, the industry still approaches BIM technology cautiously and usage of BIM is still limited. Therefore, principle contractors should have a role in pioneering the usage of BIM on construction projects.



Figure 6.8: CM challenges and corresponding BIM tools and methods

6.5 References

Arayici, Y., Egbu, C.O. and Coates, P. (2012), '[Building information modelling \(BIM\) implementation and remote construction projects: issues, challenges, and critiques.](#)', *Journal of Information Technology in Construction*, **17**, pp. 75–92.

Bennett, J. (1985), *Construction Project Management*. London: Butterworth.

Crotty, R. (2012), *The Impact of Building Information Modelling: Transforming Construction*, SPON Press, London.

Eastman C., Teicholz, P., Sacks, R., Liston K., (2011), *BIM Handbook: A Guide to Building Information Modelling for Owners, Managers, Designers, Engineers and Contractors*. Hoboken, New Jersey, Wiley.

Egan, J. (1998), *Rethinking Construction: Report of the Construction Task Force*, London: HMSO.

Faniran, O.O., Love, E.D. P., Li, H. (1999), Optimal allocation of construction planning resources, *Journal of Construction Engineering and Management*.

Harris, F., McCaffer, R., Edum-Fotwe, F., (2013), *Modern Construction Management*, New Jersey: Wiley – Blackwell 7th Edition.

Jacobi. J. (2011), '4D BIM or Simulation Based Modelling' from <http://www.structuremag.org/article.aspx?articleID=1234> accessed 24/04/2014.

Johansen, E. and Porter, G. (2003), *An experience of introducing last planner into a UK construction project*, in 11th Annual Conference of the International Group for Lean Construction, Virginia, 22–24 July, International Group for Lean Construction, Blacksburg.

Johansen, D.E. (1996), *Planning on medium sized construction project*, MPhil thesis, University of Northumbria.

SIMPLY CLEVER

ŠKODA



We will turn your CV into
an opportunity of a lifetime



Do you like cars? Would you like to be a part of a successful brand?
We will appreciate and reward both your enthusiasm and talent.
Send us your CV. You will be surprised where it can take you.

Send us your CV on
www.employerforlife.com



Jordani, D. (2008), '*BIM: A healthy disruption to a fragmented and broken process*', Journal of Building Information Modelling, Spring 2008, Matrix Group Publishing, Houston.

Laufer, A. & Tucker, R.L. (1988), *Competence and timing dilemma in construction planning*, *Construction Management and Economics*, Department of Civil Engineering, The University of New Mexico, Albuquerque.

Ng, A.K.W. and Price, A.D.F. (2005), *Assessing the impact of main contractor's site co-ordination on sub-contractors' performance in Hong Kong*. In: Khosrowshahi, F (Ed.), 21st Annual ARCOM Conference, 7–9 September 2005, SOAS, University of London. Association of Researchers in Construction Management, Vol. 1, 191–200.

Smith, A, (2012), '*Will BIM go Bang?*' accessed 24/04/2014 from <http://www.theconstructionindex.co.uk/news/view/will-bim-go-bang>

Subbiah, A. (2012), *An investigation of the factors influencing the success of construction planning for the 2012 Olympic stadium: An ethnographic study* In: Smith, S.D. (Ed) Procs 28th Annual ARCOM Conference, 3–5 September 2012, Edinburgh, UK, Association of Researchers in Construction Management, 1035–1045.

Topliss, S., Hurst, M., Skarratt Greg (2007), *BTEC National Construction, Building Services Engineering and Civil Engineering Student Book*, London: Heinemann 1st Edition.

Winter, J. and Johnson, P. (2000), *Resolving Complex Delay Claims, A report on a meeting of the UK Society of Construction Law*, at the National Liberal Club, Whitehall Place, London.

7 BIM for Facilities Management and Building Maintenance

7.1 Introduction

The recent UK Government Construction Strategy, published by the Cabinet Office in May 2011, announced that all publicly funded projects are to be delivered to level 2 collaborative BIM (with all asset information, documentation and data being delivered electronically) by 2016. This will be a driver for change in the way AEC firms hand over information to clients and owners for effective Facility Management (FM). This will not only be beneficial for public projects, it will also push the private sector to follow, especially if the public sector has success in achieving this objective.

The UK Government also aims to reduce whole-life costs by 20% and reduce carbon emissions by 80% by 2050 and the Government believes that the process of streamlining design and construction information into FM as the biggest enabler of this Government target. Through promoting the use of Building Information Modelling, the UK Government aims also to develop standards to enable all members of the supply chain to work from the same data while providing a “proper basis for asset management subsequent to construction” (Cabinet Office, 2011).

7.2 Level of developments at key project stages

It is necessary to mention that, although technology may be the catalyst, business process reform and vision is required in order to achieve a meaningful change (Jordani, 2008) within the construction process. The lessons learnt from the previous studies, research and development shows that the industry requires a clear understanding of a process reengineering to support the construction process and to streamline the construction process in a more simplistic way.

The building process involves an agile methodology for achieving effective change management practices in order to absorb any volatility. Table 7.1 below shows the proposed building lifecycle processes for BIM implementation. The proposed processes focus on smooth and seamless integration with the real-world environment to ultimately provide the least possible environmental impact alongside satisfied owners and users. During the building process, this involves the use of patterns for iteratively building the infrastructure through redistributing features and functionalities throughout the infrastructure.

Different views and perceptions of the construction lifecycle process put forward in three different countries are comparatively presented in the table below which includes process mapping from GSA (General Services Administration from USA), a Process Protocol Map from the UK, and the Senate Properties from Finland BIM Requirements 2007 documentation.

The Senate Properties' documentation for BIM implementation and its use are considered as one of the most comprehensive records in this field to date and readers are recommended to be familiar with their content. Similarly the National Building Information Model Standard Version 1.0 from NBIMS (2007) also provides comprehensive documentation. Furthermore, a process protocol map developed through research (www.processprotocol.com) represents a lean process approach for building a lifecycle process.

The table below compares these three perceptions of construction lifecycle processes.

I joined MITAS because
I wanted **real responsibility**

The Graduate Programme
for Engineers and Geoscientists
www.discovermitas.com





Month 16
I was a construction supervisor in the North Sea advising and helping foremen solve problems

Real work
International opportunities
Three work placements







GSA process (USA)	Process protocol (UK)	Mapping: Senate Properties (Finland)
Pre-task: Information Delivery Manual (IDM) methodology	Phase 0: Demonstrating the Need Phase 1: Conception of Need	3.1 Needs and objectives
	Phase 2: Outline Feasibility Phase 3: Substantive Feasibility & Outline Financial Authority Phase 4: Outline Conceptual Design	3.2 Design of alternatives 3.3 Early design
Energy analysis, cost estimating, structural analysis	Phase 5: Full Conceptual Design	3.4 Detailed design
	Phase 6: Coordinated Design, Procurement & Full Financial Authority	3.4 Detailed design
	Phase 7: Production Management	3.5 Contract tendering stage
Integrated workplace management, aggregation of information for a particular legal or operational purpose	Phase 8: Construction	3.6 Construction and commissioning
Real-time access to live facilities' models	Phase 9: Operation and Maintenance	3.6 Construction and commissioning

Table 7.1: Comparison of the proposed construction Lifecycle Process Framework with three other types of process mapping from USA, UK and Finland

With regard to integrating BIM into the business model of construction practices, the transition to BIM can be made, but it requires introspection about the business practices. The impact of BIM within the construction process at various stages is discussed in this chapter. Each organization can concentrate on, and measure, their direct or indirect involvement targeting the re-engineering of the current organizational business model. Table 7.2 shows the linkage between the Process Framework proposed and the BIM integrated process. It also provides specific names for the models created during different stages of the design process with reference to the Senate Properties' (2007) documentation.

BIM Integrated Construction Lifecycle Process	
Requirements' model, Site BIM, Inventory BIM	Space requirements, Structural requirements, Site requirements
Spatial Group BIM, Spatial BIM	Environmental impact, Energy simulations, Visualisation & environmental integration, MEP/Structural alternatives
Preliminary Building Element BIM (Pre BIM)	Building elements, Requirements of licensing and permits
BE – BIM : Quantity take off phase	True investment, MEP simulation, Sub-contractor tender calling
BE – BIM : Construction phase	Detail design, Pre-fabrication, Product planning
As-built BIM	Building construction and Site management, Facility management, Space & occupancy management, Renovations & extensions, Demolitions
Environmentally integrated BIM	BIM Handover, Product training, Future planning

Table 7.2: BIM Integrated Construction Lifecycle Process

7.3 The Value Of Information Beyond Construction

Understanding how a facility moves from ‘cradle to grave’ is important in identifying where the key stages of information handover are. The Capital Facilities Information Handover Guide (CFIHG) Part 1 (NIST, 2007) states that there are six major stages within an asset lifecycle and these are:

- Planning and Programming
- Design
- Construction
- Project Closeout/Commissioning
- Operations and Maintenance
- Disposal

Figure 7.1 shows that these stages are regarded as a traditional approach and are seen as a sequential process in a facility’s lifecycle. The smaller arrows indicate the key information handover stages (NIST, 2007).

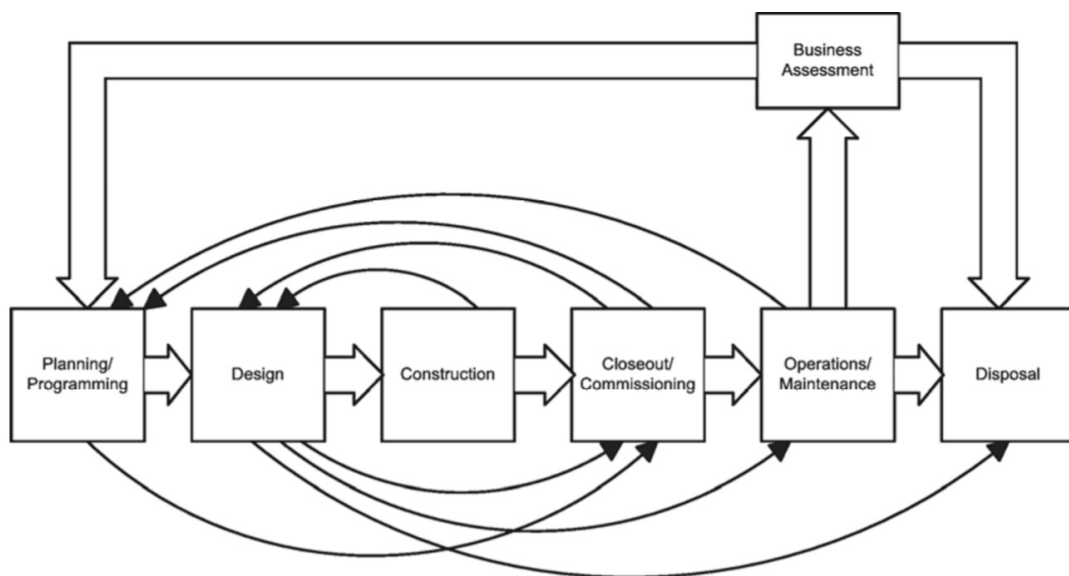

Figure 7.1: Asset lifecycle stages (NIST 7259, 2007)

However, these information handover stages are often fragmented. The operational lifecycle management of buildings is heavily dependent on the retrieval and sharing of information collected through the lifecycle stages. Problems in FM occur more when information exchange challenges are experienced during design/construction (Jordani, 2010). The blue lines in figure 7.2 show that the handover of information at each stage of the building lifecycle has to be re-created to be able to fit the receiving parties’ system and, therefore, at those handover times, information is lost (Teicholz, 2013) due to a lack of integration and interoperability between the systems used throughout the building lifecycle.



Figure 7.2: Information loss at handover stages (Teicholz, 2013)

Another challenge is that typically building information is still contractually requested by owners at the handover stages such as closeout/commissioning and operations/maintenance in paper documents' form and then is usually stored in a facilities' information storage area like the basement shown in figure 7.3. This makes it difficult and time consuming to search for relevant documents.

The advertisement features a background image of a man in a green jacket looking out over a city street. In the top left corner is the IE Business School logo. In the top right corner is a badge that reads '#1 EUROPEAN BUSINESS SCHOOL FINANCIAL TIMES 2013'. In the center right, there is a white speech bubble containing the hashtag '#gobeyond'. Below this, the text 'MASTER IN MANAGEMENT' is displayed in a white box. Underneath, a paragraph describes the program: 'Because achieving your dreams is your greatest challenge. IE Business School's Master in Management taught in English, Spanish or bilingually, trains young high performance professionals at the beginning of their career through an innovative and stimulating program that will help them reach their full potential.' Below this paragraph is a bulleted list of three benefits: 'Choose your area of specialization.', 'Customize your master through the different options offered.', and 'Global Immersion Weeks in locations such as London, Silicon Valley or Shanghai.' At the bottom, the slogan 'Because you change, we change with you.' is written in a white box. Below the slogan are the website 'www.ie.edu/master-management', the email 'mim.admissions@ie.edu', and social media icons for Facebook, Twitter, LinkedIn, YouTube, and Instagram.





Figure 7.3: FM information storage (Teicholz, 2013)

At present, as mentioned previously, owners utilize either a CMMS or CAFM system to input information manually by the facility manager from these paper documents into digital files. Furthermore, as the information is received while the building is in use, the effective use of the system is delayed until it contains the necessary data which needs to be checked for accuracy and completeness (Teicholz, 2013).

In short, inputting, verifying, and updating the information in FM systems is a costly and time consuming process. These FM systems rely on polygonal 2D information to represent spaces and/or numerical data entered into a spreadsheet (Eastman et al., 2011). The data tends to be incomplete and/or uncertain due to the fragmented approach previously addressed and illustrated in figure 7.3. Explicit information about a building would be manually input by a facility manager and this can lead to duplication of workload, implying poor data storage information systems.

A document was published in May 2011 on the UK Government Construction Strategy that identified that the inefficiencies and defects in post-handover building information are a regular feature of many construction projects and lead to the cost of remediation and possibly, also, a further cost in cases of resolving any disputes. The document highlights that it is actually very unusual to find a built asset that actually performs according to its design specification, especially with regard to energy efficiency. It further emphasises that the integration of the design and construction of an asset with the operational stages will lead to improved asset performance (Cabinet Office, 2011).

The BIM Task Group (2013) acknowledged the gap between client/design expectations and what is actually delivered, and further stated the following:

- Planning for asset management does not start early enough in the process, and this contributes to wasted time and resources even before the asset becomes operational.
- The transition from completion to operation wastes time, resources and effort before the predicated performance is achieved.
- The actual performance of an asset, especially energy performance, does not match the design specified performance.
- End user needs are often overlooked and this leads to additional expenses in ensuring that the required business functions are met.

Therefore, it is vital that the information acquired in the design and construction phases is transferred effectively into operations with maximum benefits to the owners who should also play an integral role in the entire process of a building's lifecycle to ensure that building information developed/acquired in design and construction is integrated into the operation and management stages. Increasing energy costs, material replacement and tenant turnover are just some of the challenges a building owner faces and, if a building's information is unstructured and unclear, the transition of information and its storage leads to one of the biggest challenges in FM processes, and this challenge is interoperability.

7.3.1 Interoperability as a Challenge

Inadequate interoperability contributes to the cost of sharing information between business systems at various stages of a building lifecycle, and The NIST Interoperability Study (Jordani, 2010; Arayici et al., 2012) showed that two-thirds of a building's cost is due to inefficiencies during operations and maintenance as a result of poor information and insufficient information exchange. Table 7.3 below shows the costs of inadequate interoperability by stakeholder group involved in the building lifecycle and it clearly indicates that 57.5% of inadequate interoperability is from the operations and maintenance phase of a building in comparison to the design (16.8%) and construction (25.7%) phases (Teicholz, 2013).

Stakeholder Group	Planning, Design, & Eng. Phase	Construction Phase	Operations and Maint. Phase	Total (Millions)	Pct. Of Total
Architects and Engineers	1,007.2	147.0	15.7	1,169.8	7.4%
Per square foot (SF)	0.89	0.13		1.02	
General Contractors	485.9	1,265.3	50.4	1,801.6	11.4%
Per square foot (SF)	0.43	1.11			
Special Fabricators and Suppliers	442.4	1,762.2		2,204.6	13.9%
Per square foot (SF)	0.39	1.55			
Owners and Operators	722.8	898.0	9,072.2	10,648.0	67.3%
Per square foot (SF)	0.64	0.79	0.23	1.66	
Total	2,658.3	4,072.4	9,093.3	15,824.0	100.0%
Per square foot (SF)	2.34	3.58	0.24	60.16	
Pct. Of Total	16.8%	25.7%	57.5%	100.0%	

Table 7.3: Costs of inadequate interoperability (US dollars) in 2002 (Teicholz (2013))

“I studied English for 16 years but...
...I finally learned to speak it in just six lessons”
Jane, Chinese architect

ENGLISH OUT THERE

Click to hear me talking before and after my unique course download



Therefore, enabling interoperability and streamlining processes through the AEC stages of a building project into the operations phase (thus assisting in the future operational requirements and enhancing opportunities in the building lifecycle management) can reap huge benefits, especially in lowering energy and maintenance costs.

New processes and technological advancements that assist in dealing with the challenges met by owners and facility managers attempting to implement sustainable lifecycle management (in regard to meeting legislative and sustainability requirements and environmental considerations while at the same time lowering their costs) is clearly the way forward and BIM is widely considered as the way forward for reducing these costs in the FM processes through better structuring and the streamlining of information through the lifecycle stages.

7.4 Facilities Management

The British Standard for Facility Management (BS EN 15221-1:2006 Facility Management-Part 1) describes FM as the integration of processes within an organisation to maintain and develop the agreed services which support and improve the effectiveness of its primary activities. Overall, it is the ability to effectively manage a facility to ensure it operates effectively for all who use it. The following identifies the major functional responsibilities of FM, as listed by The International Facility Managers' Association (IFMA):

- Long-range and annual facility planning
- Facility financial forecasting
- Real estate acquisition and/or disposal
- Work specifications, installation and space management
- Architectural and engineering planning and design
- New construction and/or renovation
- Maintenance and operations' management
- Telecommunications' integration, security and general administrative services

There two main types of computer FM systems which support FM functions. These are Computer Maintenance Management Systems (CMMS) and Computer Aided FM (CAFM) systems.

CMMS facilitates the management of operations and the maintenance of properties in terms of the physical and financial aspects and makes that information accessible in order to support facility-related decisions (NIST, 2007), for example, this system manages equipment and product assets relating to building services such as HVAC, electrical, water and other utilities. The system is used to record, manage and communicate day-to-day operations and helps to evaluate the effectiveness of facilities' operations (Sapp and Eckstein, 2013).

On the other hand, a CAFM system is an information rich database system (Excitech, 2011) which is used to manage spaces. The CAFM system is described by Watson and Watson (2013) as the combination of Computer-Aided Design (CAD) and/or relational database software with specific abilities for Facilities Management in order to ensure that an asset is fully utilised at the lowest possible cost at every stage of its lifecycle.

CAFM systems support the operational and strategic facility management of all the activities that are associated with administrative, technical, and infrastructural FM tasks when a facility is operational and supporting strategic planning.

Overall the two systems have different functions yet both intended to support the total FM processes. However, there are still challenges in supporting these FM processes with these existing tools and technologies.

7.5 BIM for Facilities Management

BIM as a concept has already been discussed in the previous sections. This section looks at the links between BIM and FM. As Eastman (et al. 2011) stated, BIM supports the whole lifecycle process (as shown in figure 7.4) and facilitates a more integrated design and construction process that results in better quality buildings at lower cost in addition to reducing project duration.

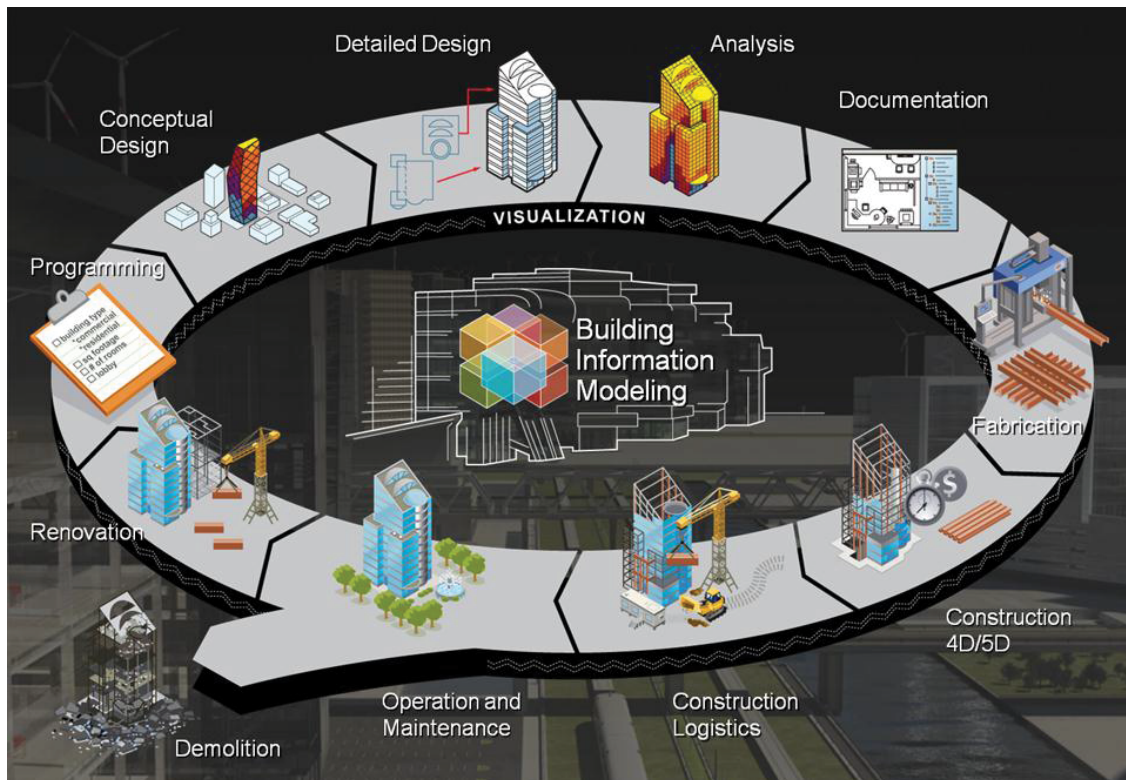

Figure 7.4: Holistic view of BIM (www.buildipedia.com)

The cost of operations and maintenance over the life of a building far outweigh any initial investment (Excitech, 2011) and, therefore, BIM and FM integration is seen as a solution to assist in the operations' phase. BIM will provide a fully populated asset data set that can be transferred into CAFM systems, will reduce the time wasted in obtaining and populating asset information, will enable the achievement of optimum performance much quicker, and will reduce running costs and refine target outcomes (BIMTG, 2013).

Integrating BIM with FM will allow key data on spaces, equipment, systems, finishes and zones (to name just a few) to be captured from BIM and, thus, such data will not need to be reentered into a downstream FM system. Thus, ultimately the the model will be used to manage the completed facilities (Lorimer, 2011).

However, currently, owners have yet to realize all the benefits that are associated with BIM or to employ all the tools and processes (Eastman et al., 2011) and very few owners have defined their actual needs and how this information can be leveraged in their management systems; therefore the AEC industry has a role in showing owners how BIM can add value to their day-to-day activities (Kasprzak & Dubler, 2012).

Although BIM does address current problems and contribute towards the return on investment (ROI), it can only be achieved through the use of BIM technology and processes (Teicholz, 2013).

Excellent Economics and Business programmes at:



university of
 groningen



**“The perfect start
of a successful,
international career.”**

CLICK HERE
to discover why both socially
and academically the University
of Groningen is one of the best
places for a student to be

www.rug.nl/feb/education



Eastman et al. (2011) suggested that owners can realize significant benefits on projects by using BIM processes and tools to streamline the delivery of higher quality and better performing buildings at the handover stage. Such benefits include:

- Improved space management
- Streamlined maintenance
- Efficient use of energy
- Economical retrofits and renovations
- Enhanced lifecycle management

Teicholz (2013) also stressed the value that can come about beyond the construction phase by integrating BIM and FM, for example, significant cost benefits for owners can be possible as it provides accurate, complete and structured information and these benefits will contribute to:

- Improved workforce efficiency
- Reduced cost of utilities (energy and water)
- Reduction in equipment failures
- Improved inventory management
- Longer equipment lives.

Eastman et al. (2011) stressed that owners, who support the whole lifecycle ownership of their project, will be able to utilise BIM to:

- Commission a building more efficiently
- Quickly populate an asset information database
- Manage facility assets with BIM asset management tools
- Rapidly evaluate the impact of retrofit or maintenance work on the facility
- Increase building performance
- Reduce the financial risks
- Shorten a project schedule
- Obtain reliable and accurate cost estimates
- Assure programme compliance
- Optimize operation and maintenance

Excitech (2011) and PSU (2013) have suggested a number of approaches on how BIM for FM can be carried out. These have been compiled and compared in table 7.4 showing their advantages and any challenges the approach provides as disadvantages.

Approach	Advantage	Disadvantages
Data attached to the model	<ul style="list-style-type: none"> • Can visually see the equipment and associated information • Quick to obtain 	<ul style="list-style-type: none"> • Requires model navigation skills by FM personnel • Can quickly become outdated • Difficult to extract into an FM system
Utilize an open standard	<ul style="list-style-type: none"> • Can populate data during all stages by all parties • All parties have access to information • Direct import/export to BIM and FM systems 	<ul style="list-style-type: none"> • Not all BIM and FM systems have the import/export capabilities.
Transfer information from BIM into FM systems using spreadsheets and manual processes	<ul style="list-style-type: none"> • Relatively low technology cost • FM team can operate without much change to current methods 	<ul style="list-style-type: none"> • Manual process, costly in regards to time • Runs risk of human error if not policed correctly • Lacks formal structure and no validation on data being entered
Transfer data into an external database or third party middleware application	<ul style="list-style-type: none"> • Easily populated • Single source of information • Enables two separate systems to interact with each other 	<ul style="list-style-type: none"> • Time to create database • Complex process to link between FM and BIM systems
Bi-directional linking between BIM and FM systems	<ul style="list-style-type: none"> • Dynamic updates of information • Reduces human error 	<ul style="list-style-type: none"> • Systems must be able to interact with each other. • Reduces the ability to share 'open' information between multiple systems

Table 7.4: Approaches to BIM use for FM showing advantages and disadvantages

All the solutions in table 7.4 will experience interoperable problems when moving information from BIM to the FM systems. Both business systems will have the problem of being able to read each other's exchanged information as Eastman et al. (2011) identified that few tools exist that can accept the input of BIM space components or other facility components representing fixed assets. Furthermore, another challenge with the handover from BIM to CMMS is that the standards and file formats common in BIM tools are not readily accepted by CMMS tools. This is a major barrier and an interoperability issue that need addressing if the handover process is to have a smooth transition and ensure that information is not lost in the process. However, the success of the integration of BIM into FM practice will bring value and benefits to all. Figure 7.5 shows the benefits for the AEC and FM industries and supports findings within the literature.

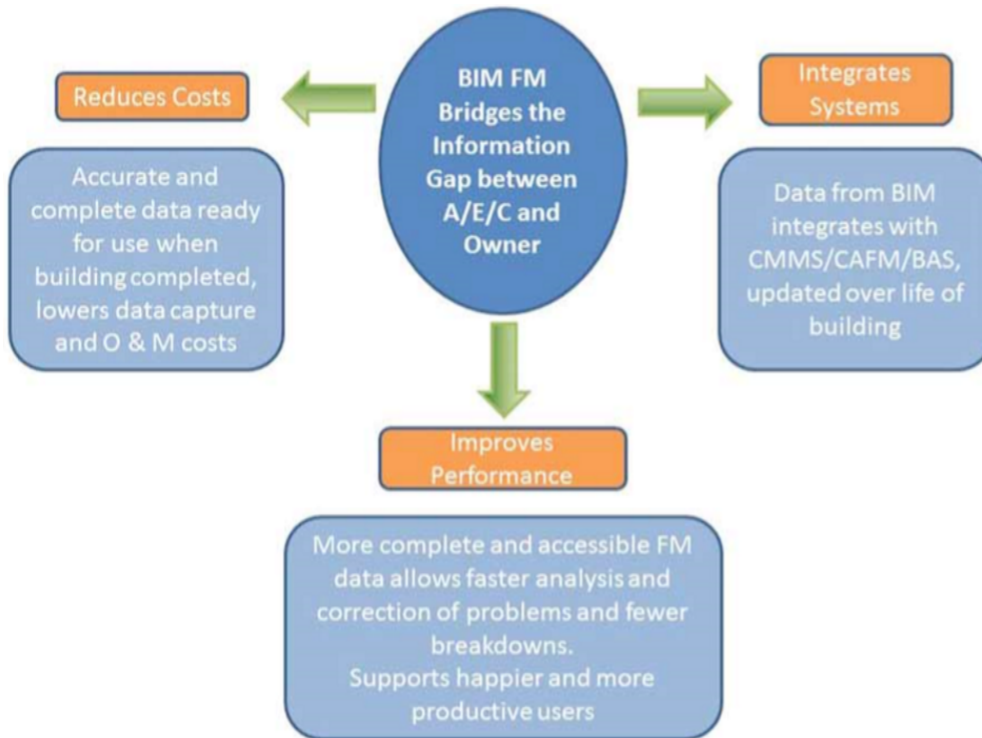

Figure 7.5: Benefits of BIM FM Integration (Teicholz, 2013)

American online LIGS University

is currently enrolling in the
Interactive Online **BBA, MBA, MSc,**
DBA and PhD programs:

- ▶ enroll **by September 30th, 2014** and
- ▶ **save up to 16%** on the tuition!
- ▶ pay in 10 installments / 2 years
- ▶ Interactive **Online** education
- ▶ visit www.ligsuniversity.com to find out more!

Note: LIGS University is not accredited by any nationally recognized accrediting agency listed by the US Secretary of Education. More info [here](#).



7.6 Strategies for Model Maintenance

In moving towards level 2 BIM, many standards and processes, with the support of technology, are being developed. Figure 7.6 shows the process within the information cycle (defined in PAS 1192-2 by BSI (2013)) of how the assets in the Capital Expenditure (Capex) phase will help link accurate information into the Operation Expenditure (Opex) phase towards providing a whole lifecycle analysis for facility managers. It shows the key documents and workflows that support a fully integrated approach to BIM and FM. Some of these processes and standards, especially for model maintenance strategies, are discussed in detail in the following sections.

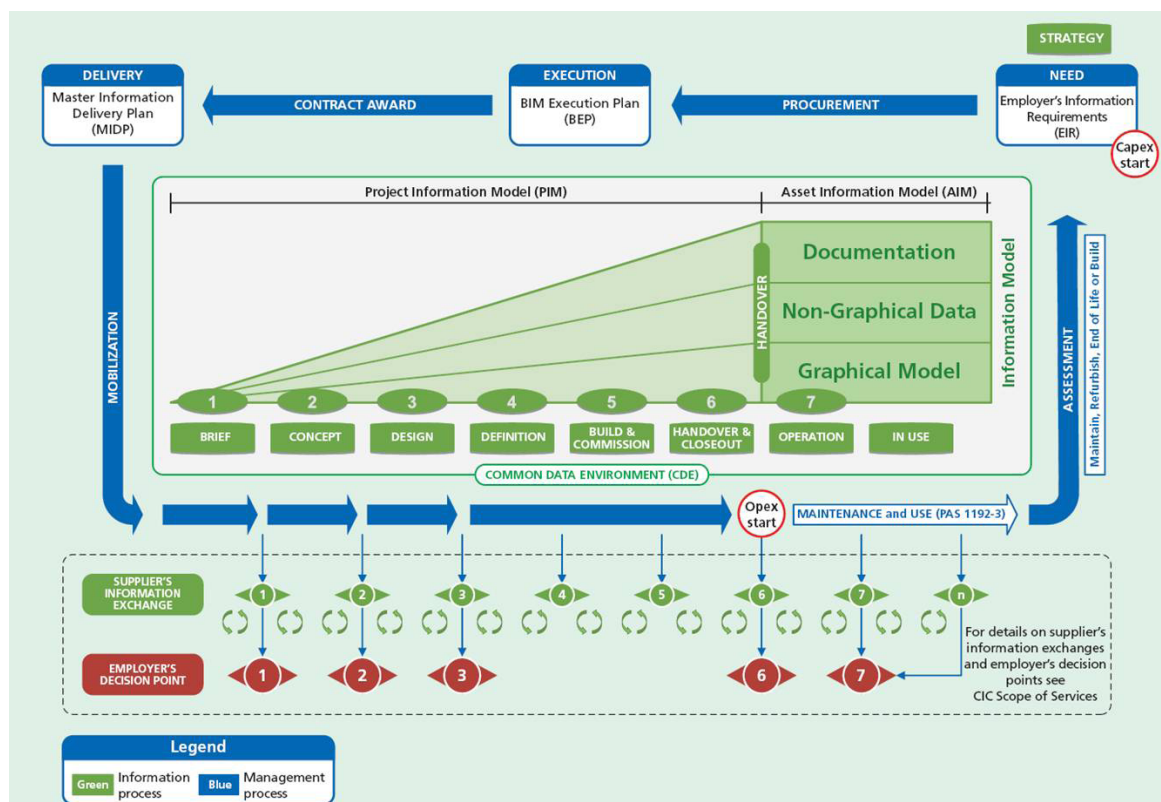

Figure 7.6: The Information delivery cycle in PAS1192-2 (BSI, 2013)

7.7 Applying Government Soft Landings (GSL) Policy

The ‘soft landing’ was identified as a way of improving the performance of buildings and of meeting the requirements of users (Cabinet Office, 2013). This policy aims to bridge the gap between expectation and reality through engaging users and operators to review and comment upon design, construction, commissioning and handover proposals (BIMTG, 2013). The policy is intended to enable a smooth transition from the design and construction phase to the operational phase of a built asset (Cabinet Office, 2013) and, combined with the concept of a 3 year Post Occupancy Evaluation (POE) period, it seeks to compare the required outcomes with the actual performance (Cabinet Office, 2013).

By applying the GSL policy, these potential benefits can be achieved (Cabinet Office, 2013):

- Help in defining the required performance and operational outcomes to meet the end user needs.
- End user involvement at the early stages to improve operational performance.
- Lifecycle operational expenditure is considered rather than merely capital expenditure.
- Data capture from Construction Operations Building Information Exchange (COBie) to CAFM to reduce input into FM systems.
- Commissioning and handover information is provided in a timely manner reducing costs that are brought about by a protracted handover process.
- Clear measurement of building performance up to 3 years’ post completion.
- Designers and constructors get to understand the outcomes from their design and how they can narrow the gap between design intent and actual performance.

Applying the GSL policy will enable a collaborative working approach through the supply chain, from design, construction & FM for model building and maintenance throughout the project lifecycle.

7.8 Initiating Employers’ Information Requirements (EIR)

An EIR is a pre-tender document that sets about identifying the information to be delivered and the standards and processes that are to be adopted by the project stakeholders (BSI 2013).

PSU (2013) state that, if owners are aware of the information they need for operations and maintenance, they can now start to specify the exact information they wish to receive in a modifiable electronic format so that they can then incorporate this into their FM systems.

Hardin (2009) stated that it is an owner’s decision as to whether to demand having a BIM model with a clear specification of what components are needed in the model. EIR is a mechanism to put this demand in at the pre-tender stage. Employers, by defining the information they require and in what format they require it, will start to decrease the time and cost of populating the facility management system and increase the ability for model maintenance (PSU, 2013). Figure 7.7 shows the core contents of an EIR.

Technical	Management	Commercial
<ul style="list-style-type: none"> ○ Software Platforms ○ Data Exchange Format ○ Co-ordinates ○ Level of Detail ○ Training 	<ul style="list-style-type: none"> ○ Standards ○ Roles and Responsibilities ○ Planning the Work and Data Segregation ○ Security ○ Coordination and Clash Detection Process ○ Collaboration Process ○ Health and Safety and Construction Design Management ○ Systems Performance ○ Compliance Plan ○ Delivery Strategy for Asset Information 	<ul style="list-style-type: none"> ○ Data drops and project deliverables ○ Clients Strategic Purpose ○ Defined BIM/Project Deliverables ○ BIM-specific competence assessment

Figure 7.7: Core contents of EIR (BIM Task Group, 2013)

7.9 Producing a BIM Execution Plan (BEP)

The BEP is a response to the EIR from the project teams. Developing a BIM Project Execution Plan is beneficial to owners to assist in model maintenance for use in FM. The BEP should enable the project team to ensure that the requirements within the EIR are achievable. Therefore, it should contain fundamental owner specified information and requirements (PSU, 2013).

BEP should specify a workflow for transferring FM data from the BIM to the CMMS whether directly, or through the use of middleware, for the interchange of information between the CMMS and the BIM model (Teicholz, 2013).

Since BEP paves the way for how the BIM use should be in a project, the BIM execution plan requires input from all stakeholders.

.....Alcatel-Lucent 

www.alcatel-lucent.com/careers

What if you could build your future and create the future?

One generation's transformation is the next's status quo. In the near future, people may soon think it's strange that devices ever had to be "plugged in." To obtain that status, there needs to be "The Shift".



7.10 Involving FM in Common Data Environment (CDE)

A CDE is defined by PAS1192-2 (2013) as a single source of information for any given project, used to collect, manage and disseminate all relevant approved project documents for use by multi-disciplinary teams in a managed process. This environment of a single source for data storage ensures confidence between all parties in the information being shared and ensures that it is up-to-date, accurate and fit for the intended purpose. The advantages of deploying a CDE for all stakeholders (PAS1192-2, 2013) will ensure the following:

- Ownership of the information remains with the originator. Although the information is shared and reused, only the originator shall change it.
- Shared information will reduce the time and cost in producing co-ordinated information.
- Any number of documents can be generated from different combinations of model files.

As the client/facility manager have access to this environment, through the client shared area, this will enable them to comment on the information captured by teams for their FM purposes and ensure that their requirements are met as prescribed in EIR.

7.11 Technologies for Model Maintenance

Technologies, and their supporting IT infrastructure, will support standards and processes and will play a vital role in the development of BIM and FM integration. Eastman et al. (2011) looked at a range of technologies (such as mobile computing and remote sensing technologies like GPS, RIFD and laser scanning) to ascertain if there could be greater use of BIM in the field to help capture accurate as-built information that could be handed over in confidence to the owner. These emerging technologies are discussed below.

7.11.1 Cloud Computing

Cloud computing has been a huge and dynamically growing trend in the IT industry. It is a set of pooled computing resources and services delivered over the web. **Chuang et al. (2011) stressed that cloud computing allows BIM models to be manipulated through the web without the limitations of time or distance and can** facilitate communication and distribution of information between related participants, such as construction companies, building owners and architectural companies, in order to manage projects effectively and efficiently. Figure 7.8 shows how cloud computing connects AEC and FM operations, model maintenance and helps towards obtaining level 3 BIM.

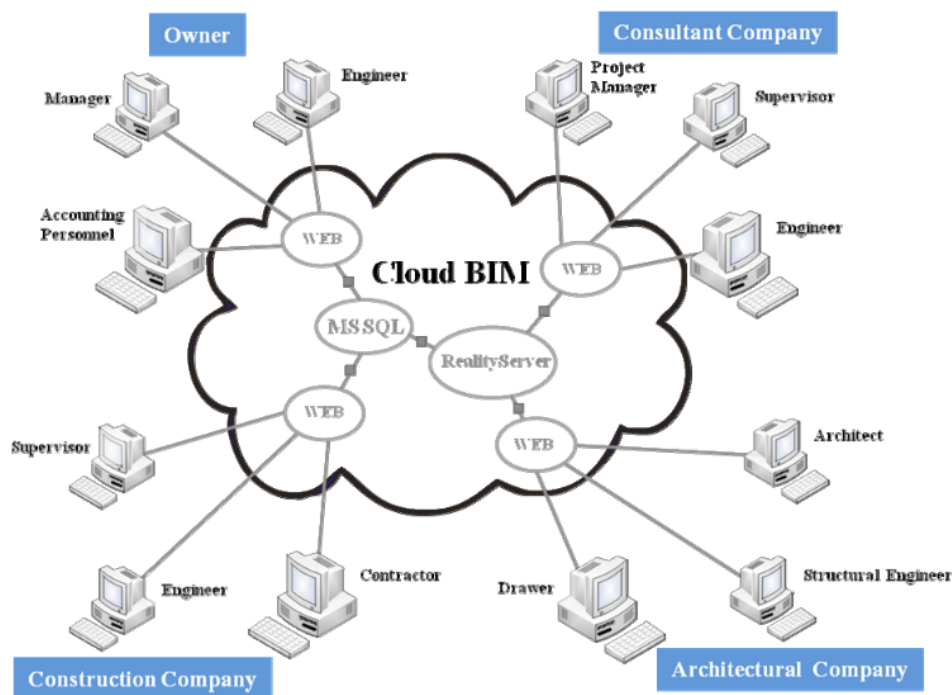

Figure 7.8: Cloud computing for AEC and FM for model maintenance (Chuang et al., 2011)

However, there are concerns about utilising cloud computing for information sharing in relation to data security, privacy and control of data. However, the advantages outweigh the disadvantages as cloud based services will decrease the in-house IT requirements of an organisation and its ability to support BIM related analytics and real time commissioning (Teicholz, 2013).

7.11.2 Mobile computing

As employees begin to access BIM information via the cloud, it is only a matter of time before they demand access via their mobile devices. With mobile technologies becoming part of everyday life, the potential to utilise this technology will help in the sharing of facility information in the building industry (Teicholz, 2013).

Mobile technologies will provide the ability to retrieve, collect, update and share information to support the activities of FM such as inventories, inspections, repair, maintenance and alterations.

7.11.3 RFID/QR code/Barcode Technologies

Radio-frequency identification (RFID), Quick Response codes (QR) and barcoding are wireless non-connect systems that allow information to be transmitted from a tagged object to a database through the use of a mobile scanning device. These three practices are different systems and function differently; however, they have the same process, namely the end goal of tagging components and linking them to a database.

RFID, QR or bar codes are placed on real components and that code is represented in the BIM model and is linked via a database or supporting software application, and will support the tracking of a components delivery, installation and commissioning status (Eastman et al 2011).

Addition to the obvious benefits of these technologies (such as tracking materials and components and indicating their delivery and installation status), they help to capture the correct as-built information and support the handover of reliable and correct information to facility managers. Using these mobile readers via mobile devices to tag and track assets, an RFID can be affiliated to components in the BIM and will allow facility managers to display and identify assets behind walls, under floors or above ceilings (Teicholz, 2013).

RFID has advantages over barcoding for asset management is that the tags are small and made out of thick plastic, whereas barcodes are stickers that can run the risk of being scratched or tarnished, which renders them useless.

Overall, these technologies support the role of the facilities manager, as the ability to place an RFID tag on a piece of equipment can report information about that equipment and such tags will support maintenance personnel to identify where the equipment is located and the work required on it (Hardin, 2009).

Join the best at the Maastricht University School of Business and Economics!

Top master's programmes

- 33rd place Financial Times worldwide ranking: MSc International Business
- 1st place: MSc International Business
- 1st place: MSc Financial Economics
- 2nd place: MSc Management of Learning
- 2nd place: MSc Economics
- 2nd place: MSc Econometrics and Operations Research
- 2nd place: MSc Global Supply Chain Management and Change

Sources: Keuzegids Master ranking 2013; Elsevier 'Beste Studies' ranking 2012; Financial Times Global Masters in Management ranking 2012

Visit us and find out why we are the best!
Master's Open Day: 22 February 2014

Maastricht University is the best specialist university in the Netherlands (Elsevier)

www.mastersopenday.nl



7.11.4 Sensor Data

Sensor data plays an important part in Post Occupancy Evaluation (POE) and determining whether the design specifications match the actual performance of a facility. Sensors deliver detailed information about the operation of the building, as it is occurring in real time, and they can monitor the building environment and track the movement of objects and people within the building (Coates et al., 2011).

The basic types of sensors that can be utilised within a facility to capture performance data are shown in table 7.5. With the effective collection of this real time data, the BIM model can be maintained to generate a building operational model (Coates et al., 2011). Although a BIM model is an ideal platform for their deployment, sensor systems produce a tremendous amount of data (which significantly improve the decision-making processes in the lifecycle management), and the ability to handle this large volume of datasets is a challenge (Eastman et al., 2011).

However, once these technological barriers are addressed, the use of sensors for POE has the potential to lower the bottom line of the cost of operating and maintaining a building, and the use of BIM with sensors can provide a visual framework to display performance data and, subsequently, real time data performance feedback, such as power usage, could be displayed.

Classification of sensors	Sensors
HVAC and indoor air quality	<ul style="list-style-type: none"> • Temperature sensors • Humidity sensors • Carbon oxides sensors
Occupancy sensors	<ul style="list-style-type: none"> • Motion sensors attached to lighting systems
Safety and security sensors	<ul style="list-style-type: none"> • Motion sensors • Fire detecting sensors • Gas detecting sensors • Smoke detectors
Outdoor sensors	<ul style="list-style-type: none"> • Outdoor motion sensors for security • Compact weather stations

Table 7.5: Types of sensors (Coates, Arayici & Ozturk, 2011)

7.11.5 BIM Component Data (BIM Object Libraries)

The use of prebuilt models of building components will help AEC and FM teams accelerate the design process and deliver high-quality, as-built drawings to owners. BIM components or objects contain accurate and complete data, thus they will help to provide information from a single source rather than multiple datasheets which are normally filed away or manuals (Teicholz, 2013).

Information about construction elements are stored within the model components by inputting information into the elements' properties directly (Hardin, 2009) and this supports multiple workflows for exercises such as energy and sustainability analyses, quantity take-offs and cost estimating, operational cost analysis, security analysis and many of the soft and hard issues of FM tasks (Arayici et al., 2012). For example, the National BIM Library in the UK, developed and managed by the National Building Specification, is an online resource which allows the UK construction industry to use, free of charge, generic and proprietary BIM objects (National BIM Library, 2013).

This online library of manufacturers' data rich proprietary objects linked to the National Building Specification will help establish a common approach to quality standards across AEC FM with a view to encouraging consistency and collaboration (NBL, 2013). This library of manufacturer details will centralise information for AECFM professionals and will help structure the information required for handover and support facility managers by providing them with accurate information with regard to their facility's model maintenance.

7.11.6 Construction Operations' Building Information Exchange (COBie)

COBie is an international standard that delivers managed asset information and improves the exchange of maintenance information. The COBie specification defines the information needed for handover requirements which includes physical materials, products and equipment, equipment locations, serial numbers, warranties and spare parts' lists (NIST, 2007).

It delivers consistent and structured asset information useful for an owner-operator for post-occupancy decision-making. It can be considered as a vehicle for sharing predominantly non-graphic data about a facility and, through being a non-proprietary format based on a multiple page spreadsheet, it can easily be managed by organisations of any size and at any level of IT capability. The structure of COBie is shown in figure 7.9 where information about assets is structured in a unified way.

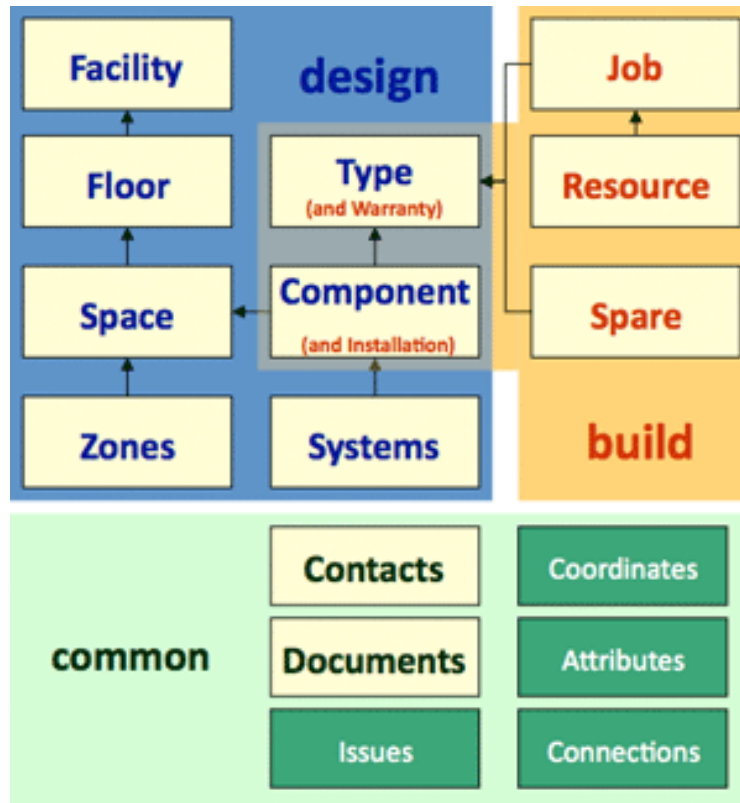

Figure 7.9: The COBie Structure (www.wbdg.org)

> Apply now

REDEFINE YOUR FUTURE
AXA GLOBAL GRADUATE PROGRAM 2015

redefining / standards 



The COBie approach consists of all the project stakeholders capturing facility data gradually during key project stages, known as **data drops** (see figure 7.10) and then exporting and importing this data into a central database to encourage an open format approach, not just at handover, but throughout the entire project lifecycle. It aims to streamline the handover process between the construction and operations phases and also to support the model maintenance through the facilities' lifecycle (NIST, 2007).

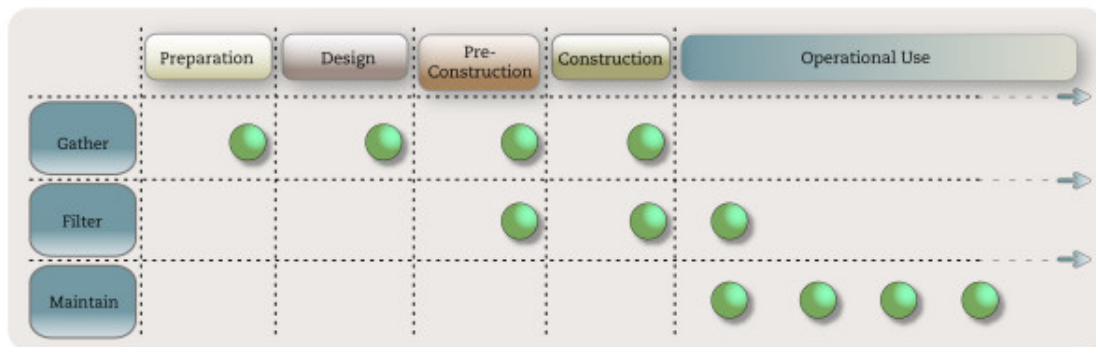

Figure 7.10: COBie data drops throughout a project's lifecycle (www.fmmagazine.com.au)

There are four ways of creating and updating the delivery of COBie and these consist of:

- Manually entering data in the COBie spreadsheet.
- Extracting BIM attribute data and importing into a COBie compliant file.
- Direct use of COBie compliant software.
- Exporting an Industry Foundation Classes' (IFC) file with correctly structured property sets.

However, Kasprzak & Dubler (2012) stated that information exchange from construction to operations is not a seamless process, as COBie is not yet capable of integrating effortlessly into an existing and extensive FM database as only certain selected software applications can seamlessly support this desired integration.

Interoperability is currently possible between certain software applications and end users need to still spend considerable time on manually adjusting, exporting and importing COBie data into their FM systems, which is what occurs in current FM processes. So although the information can be exchanged, this is mostly undertaken by manual processes. Therefore, in order to move the industry forward in the development of this exchange process, owners and project teams should share and standardize this process (Kasprzak & Dubler, 2012).

7.11.7 Industry Foundation Classes (IFC)

IFC is an open, neutral and standardised specification for BIM which is developed and maintained by buildingSMART. It utilises common data schema that makes the exchanging of information between different software applications possible and helps enhance interoperability. The schema is designed to hold and exchange information that covers many disciplines and which contributes to a building throughout its lifecycle, from conception, through design, construction and operation to refurbishment or demolition (BuildingSMART, 2013). This open format does not belong to a single software vendor and is independent of any particular vendor's plans for software development. So IFC can also be considered as non-proprietary data model for BIM model maintenance.

7.11.8 International Framework for Dictionaries (IFD)

Information standardization is another driver for progress (Eastman et al., 2011) and IFD is used to address the issue of mapping terms between different languages to allow a wide utilisation of terms within BIM (Eastman et al., 2011).

IFD has created a catalogue or dictionary of objects that will bring together construction and asset information, whether it is from a product manufacturer, whether it is cost data or spatial requirements, into a common view and it also copes with different languages. Consistent definitions of building types, space types, building elements and other terminology will facilitate e-commerce and increasingly complex and automated work-flows. This specification can be used within different applications such as in the field of energy, in carbon footprint analysis and provides useful features for facility managers (Eastman et al., 2011). If information from all languages can be classified or structured correctly every user of the model will understand the content within it and be able to utilise it for model maintenance and their everyday tasks.

7.12 Conclusions

There are commonly accepted exemplary lifecycle processes such as Senate Properties, GSA processes, process protocols, and all these entail BIM use throughout the lifecycle process for building information management. To appreciate the value of the information requirements beyond construction, it is necessary to explore the key challenges occurring in FM processes such as interoperability and integration challenges, information loss, paper-based documentation, inaccurate building performance assessment, low quality FM activities, etc.

Based on research findings, two thirds of a building's cost occurs at the operation and maintenance stage, which clearly reflects how important and valuable information is at the stages beyond construction.

FM systems can be classified into two systems: Computer Maintenance management systems and Computer Aided FM systems. Although these systems are complementary, there are challenges in supporting FM processes with these technologies.

BIM has potential to overcome these challenges in FM including such factors as improved space management, streamlined maintenance, efficient energy use, economical retrofits and renovations, and enhanced lifecycle management. All these benefits can be expanded.

Policies, standards, processes and technologies such as the information delivery cycle, the soft landing policy, employer information requirements, cloud computing, mobile computing, scanning technologies, sensor technologies, COBie standards and IFDs.

7.13 References

Arayici, Y., Onyenobi, T., Egbu, C. (2012), Building Information Modelling (BIM) for Facilities Management (FM): The Mediacity case study approach. *International Journal of 3-D Information Modelling*, 1 (1), 55–73. doi: 10.4018/ij3dim.2012010104.

Building Information Modelling (BIM) Task Group, (2013), Employers Information Requirements: Core Content and Guidance Notes. Retrieved 29 October, 2013, from <http://www.bimtaskgroup.org/wp-content/uploads/2013/04/Employers-Information-Requirements-Core-Content-and-Guidance.pdf>



Empowering People. Improving Business.

BI Norwegian Business School is one of Europe's largest business schools welcoming more than 20,000 students. Our programmes provide a stimulating and multi-cultural learning environment with an international outlook ultimately providing students with professional skills to meet the increasing needs of businesses.

BI offers four different two-year, full-time Master of Science (MSc) programmes that are taught entirely in English and have been designed to provide professional skills to meet the increasing need of businesses. The MSc programmes provide a stimulating and multi-cultural learning environment to give you the best platform to launch into your career.

- MSc in Business
- MSc in Financial Economics
- MSc in Strategic Marketing Management
- MSc in Leadership and Organisational Psychology

BI NORWEGIAN BUSINESS SCHOOL

EFMD **EQUIS** ACCREDITED

www.bi.edu/master



Cabinet Office, (2011), Government Construction Strategy, Retrieved from https://www.gov.uk/government/uploads/system/uploads/attachment_data/file/61152/Government-Construction-Strategy_0.pdf

Cabinet Office, (2013), Government Soft Landings Section 6 – Facilities Management, Retrieved from <http://www.bimtaskgroup.org/gsl-department-guidance-documents/>

Chuang, T.H., Lee, B.C., Wu, I.C. (2011), Applying cloud computing technology to BIM visualization and manipulation, In Proceedings of the 28th International Symposium on Automation and Robotics in Construction (ISARC), Seoul, Korea (pp. 144–149), Retrieved from <http://www.iaarc.org/publications/fulltext/S04-4.pdf>

Coates, P., Arayici, Y., & Ozturk, Z. (2011), *New concepts of Post Occupancy Evaluation (POE) utilizing BIM benchmarking techniques and sense devices*, Paper presented at the SEB 11 Sustainability in Energy and Buildings, 1–3 June 2011, Marseilles, France. Retrieved from <http://usir.salford.ac.uk/16620/>

Eastman, C., Teicholz, P., Sacks, R., & Liston, K. (2011), *BIM Handbook: A Guide to Building Information Modelling for Owners, Managers, Designers, Engineers, and Contractors* (2nd ed.). Hoboken, New Jersey: John Wiley & Sons, Inc.

Excitech, (2011), From Building Information Management to Facilities Management, Retrieved 4 August, 2013, from <http://www.excitech.co.uk/resources/white-papers.asp>

Hardin, B. (2009). *BIM and Construction Management: Proven Tools, Methods and Workflows*. Indianapolis, Indiana: Wiley Publishing, Inc.

Jordani, D. (2008). BIM: A healthy disruption to a fragmented and broken process. *Journal of Building Information Modelling*, 24–26.

Jordani, A.J. (2010), BIM and FM: The portal to lifecycle facility management, *Journal of Building Information Modeling*, 13–16.

Kasprzak, C., & Dubler, C. (2012), Aligning BIM with FM: Streamlining the Process for Future Projects, *Australasian Journal of Construction Economics and Building*, 12(4), 68–77. Retrieved from <http://epress.lib.uts.edu.au/>

Lorimer, J., (2011). Why do we need BIM? Retrieved 17 October, 2013, from <http://www.thenbs.com/topics/bim/articles/whyDoWeNeedBIM.asp>

National Institute of Standards and Technology, (NIST) (2007), General Buildings Information Handover Guide: Principles, Methodology and Case Studies, *An Industry Sector Guide of the Information Handover Guide Series (NISTIR 7417)*, US Department of Commerce.

BSI (2013), PAS 1192-2: Specification for information management for the capital/delivery phase of construction projects using building information modelling, British Standards institute, ISBN 978 0 580 78136 0.

Pennsylvania State University, (2013), Building Information Modelling: Planning Guide for Facility Owners. Retrieved 24 October, 2013, from <http://bim.psu.edu/Owner/Resources/default.aspx>

Sapp, D. & Eckstein, D., (2013), Computer Maintenance Management Systems (CMMS), Retrieved 5 October, 2013, from <http://www.wbdg.org/om/cmms.php>

Teicholz, P. (Ed.), (2013), *BIM for Facility Managers*, Hoboken, New Jersey: John Wiley & Sons, Inc.

Watson, J.R. & Watson, R. (2013), Computer Aided Facilities Management (CAFM), Retrieved 5 October, 2013, from <http://www.wbdg.org/om/cafm.php>

Need help with your dissertation?

Get in-depth feedback & advice from experts in your topic area. Find out what you can do to improve the quality of your dissertation!

Get Help Now



Go to www.helpmyassignment.co.uk for more info



Helpmyassignment



8 Benefits and Challenges

8.1 Introduction

The new international benchmark for efficiency in design, construction and building maintenance is now BIM. In the design, construction, and facility management stages and even for the whole lifecycle the use of BIM is advantageous. Among stakeholders in the construction industry all over the world, BIM has attained an extensive popularity because of the platform it provides for collaboration. It has been observed that many stakeholders within construction organizations around the world are moving towards the adoption of BIM in their respective practices (Haron et al., 2009). Arayici et al. (2009) have reported that, recently, UK, Australia, Sweden, Norway, Finland, Germany and France, within their construction processes, in order to facilitate the construction lifecycle, have demonstrated the capability of using BIM in many pilot and live projects which have been completed and documented.

BIM brings all the required documents needed for a project into a single linked model whereas CAD has no such intelligent linkage. The time efficiency difference between BIM and CAD is tabulated below in table 8.1.

Task	CAD (hours)	BIM (hours)	Hours saved	Time savings
Schematic	190	90	100	53%
Design development	436	220	216	50%
Construction documents	1,023	815	208	20%
Checking and coordination	175	16	159	91%
Totals:	1,824	1,141	683	

Table 8.1: The time efficiency difference between CAD and BIM applications (Rundell, 2007)

In order to understand the main difference between BIM and CAD, an example is presented of a wall in a building design, its representation and construction. In a CAD platform, a wall is represented by two lines which is a 2D documentation created separately with no intelligent connection while in a BIM platform, the wall is created as an interactive tool which has its own unique qualities such as width, material, demolished or new, and a specification is connected to it. There are crosslinks in the data among associated objects in the BIM platform which are arranged perfectly unlike CAD which has separate sheets.

This was a gentle introduction to BIM and its benefits over CAD. In the next section, benefits and challenges of BIM are elaborated further.

8.2 Benefits and challenges of BIM

BIM can provide many benefits throughout a lifecycle ranging from improved sharing of information and a better design through to having better communication, improved quality control and increased productivity efficiency (McGrawHill Construction, 2012). However, BIM drastically changes the process of designing and building in the construction industry. In addition, as added benefits, there is an increase in the productivity of structural engineering practices which have adopted BIM (from 15% to 41%) (Sack and Barack, 2007), and improved profitability on BIM investments due to eliminating time and on-site clashes (Azhar et al., 2008).

The ultimate benefit of BIM, in short, can be described as bringing time and cost efficiencies for the design construction together with better quality (sustainable) building at a lower cost (lifecycle cost/benefit). This benefit oriented justification of BIM can be seen abstract and intangible. Therefore, the following subsections will present some core examples of BIM benefits.

8.2.1 Some Examples of BIM Benefits

From the BIM literature of research and practice, BIM provides certain benefits for the construction industry:

- Effective and rapid development appraisal
- Clash detection and coordination improvement
- Integrated design and planning applications
- 3D and 4D Visualisation at the design stage
- Effective and sustainable product selection
- Automated energy assessments
- FM information capture prior to construction
- Proactive maintenance
- Accurate quantity take-offs/Cost estimation and management
- Virtual pre construction
- Rapid revision control

Some of these benefits are further elaborated below.



Brain power

By 2020, wind could provide one-tenth of our planet's electricity needs. Already today, SKF's innovative know-how is crucial to running a large proportion of the world's wind turbines.

Up to 25 % of the generating costs relate to maintenance. These can be reduced dramatically thanks to our systems for on-line condition monitoring and automatic lubrication. We help make it more economical to create cleaner, cheaper energy out of thin air.

By sharing our experience, expertise, and creativity, industries can boost performance beyond expectations. Therefore we need the best employees who can meet this challenge!

The Power of Knowledge Engineering

Plug into The Power of Knowledge Engineering.
Visit us at www.skf.com/knowledge

SKF



8.2.1.1 Clash Detection and Coordination Improvement

An important advantage of BIM is the coordination of documents utilised by different designers and engineers who are collaborating during the project design stage. This synchronizes the building structural elements, improves the building services systems and detects conflicts between the structural elements. Furthermore, the savings on labour cost can be about 30% by improving services via BIM-enabled coordination because of BIM (Khazode et al, 2008). Trade specialist subcontractors, such as the manufacturers of concrete and prefabricated steel structures value BIM-enabled coordination as it significantly reduces errors during the construction stage (Kaner and Sack, 2008; Arayici et al., 2012).

8.2.1.2 3D and 4D Visualization from Design Stage

The 3D visualization of a building early in the design stage helps the client and other stakeholders establish a shared understanding as to how the finished building will be at the abstract level and at the fine detail level. In other words, BIM usage gives the opportunity to design and construct a virtual prototype of the building project shared in a virtual environment before the physical construction starts. Furthermore, the integration of construction programmes with the BIM model enables 4D construction planning simulation and monitoring during the actual construction providing critical benefits for construction planners and managers, providing a time saving of up to 19% from the planned project time (Suermann, 2009).

In addition, the ability to experience the building before its construction in both 3D and 4D is also found to be beneficial in accelerating the process of obtaining building permits, and in eliminating any possible misunderstanding about design intent.

3D visualizations also prove to be useful for avoiding design errors and problems in the following (Constructing Excellence, 2008):

- precast concrete panels,
- reinforcement strands' arrangements,
- complex pipe runs and service connections in structural steel,
- concrete beams in the same column intersections.

8.2.1.3 Cost Estimation and Management Accuracy

Having a BIM-enabled digitally designed building before starting actual construction is very beneficial also for estimators and Qs to be able to accurately estimate construction costs, depending on the quantities and schedules automatically generated by the BIM model; the bill of quantities is automatically updated when the BIM model is changed or updated in the design process, leading to the maintenance of a high level of accuracy in the quantities. For example, if a client needs to see the financial impact of any change requests and other variations, such financial impacts can be accurately and automatically provided; this is described as 5D cost estimation and simulation at the detailed design stage.

8.2.2 Challenges for BIM

Although there are many benefits to be gained in adopting BIM (some examples are given above), there are also other factors that have a negative impact on the rate of BIM absorption in the AEC industry; barriers such as cost, training, interoperability, and changes in the overall design process are commonly found reported in different literature around the globe. The most common of these barriers are described in more detail below.

8.2.2.1 Cost of BIM Adoption

The initial costs to move from traditional approaches (2D, 3D and CAD) to BIM are considered substantial, both in terms of the costs of BIM software and the upgrade hardware to be able to manage BIM. The initial purchase cost of BIM software is usually a significant investment (www.lbms.com.au).

8.2.2.2 Training and Up-skilling

The training and up skilling of staff have a large impact on the overall cost of BIM adoption as the high cost of the initial investment for staff training has been described widely in the literature. However, training is essential to enhance the implementation of BIM and, without well-trained users, the degree of BIM usage cannot move forward. BIM implementation experiences clearly show that the obstacles met were less on technical issues, such as hardware and software, than on training and the availability of qualified personnel (Arayici and Coates, 2013) indicating that the technical development of BIM has gained more speed when the staff has become more knowledgeable and skilled; in other words, diminishing resistance to change and creating a demand for improvement via BIM adoption.

8.2.2.3 Interoperability

Interoperability between different BIM tools is one of the main challenges. Although BuildingSmart (formerly known as the International Alliance for Interoperability (IAI)) has set the standard Industry Foundation Class (IFC) for BIM models, the translation of BIM models, based on IFC, from one BIM tool to another is not always accurate and some data loss usually occurs owing to the translation via IFC.

Interoperability is regarded as a major requirement to ensure that the AECO industry attains efficiencies and effectiveness via successful BIM use. Interoperability is being addressed by the vendors to improve communication and information sharing without any data loss through various discipline-based BIM tools. For example, the family of Autodesk Revit includes specific standalone packages for architecture, structure, and services (MEP) which are fully compatible with each other. However, they are all from the same vendor. Interoperability issues occur when BIM data exchange is required between tools from different vendors such as Autodesk, Graphisoft, Nemetschek, Bentley, etc. Such companies should work together with BuildingSmart to improve the IFC data model for zero error during translation from one system to another in order to overcome the interoperability challenges.

8.2.2.4 Changes in the Process

BIM adoption requires a complete change in both design and construction processes, for example, a possible change in the workload at the early design stages of a project where engineering and contractor knowledge and design skills would be needed to produce the initial model of the building. This is an important change in the workload allocation resulting in increased fees for professional design services. This means that the stakeholders producing the BIM model at the early design stage should not only be knowledgeable about BIM, but also require a better understanding of the downstream construction engineering and management as well as good communication and team working to ensure that produced BIM model efficiently evolves through the design and construction process.

Such process challenges require a change also in the work practices of the designers/engineers and drafters who currently exist in architecture and engineering practices. While some consider the paradigm shift in the design process as a positive sign (since it will potentially improve quality and profitability and promote greater collaboration between stakeholders), others claim that resistance and defiance to change is a spirited challenge in BIM uptake.



"I studied English for 16 years but...
...I finally learned to speak it in just six lessons"

Jane, Chinese architect

ENGLISH OUT THERE

Click to hear me talking before and after my unique course download



8.2.3 A Systemic Classification of BIM Challenges

While the previous section highlighted some of the key challenges, commonly accepted in research and practice, this section will look at those challenges more systematically from a holistic perspective in order to ensure successful diagnosis. Therefore, BIM challenges and barriers are classified into 5 categories as illustrated in figure 8.1 below. These are, namely, technology, process, policy, people and culture, and market place.

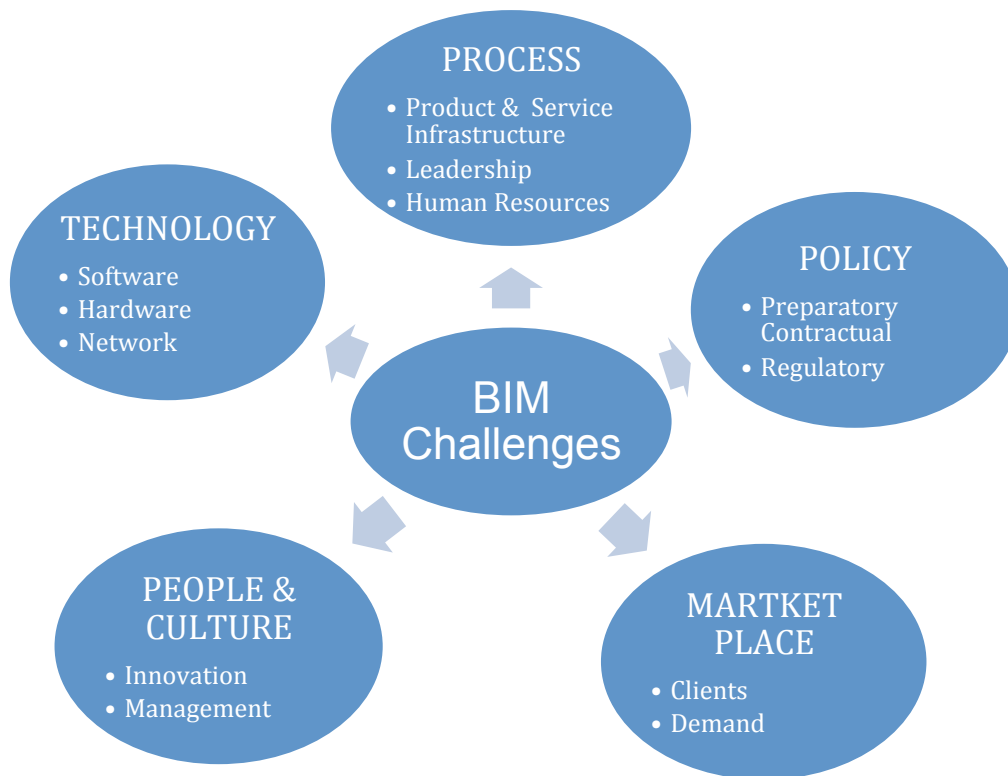

Figure 8.1: Classification of BIM Challenges

The above diagram shows the relationship between, and the categories of, BIM challenges in a mind map format. This is to simplify knowledge of what issue is under which aspect to provide a better understanding and diagnosis of those challenges. These 5 classes will be discussed below.

8.2.3.1 Technology Set

Software: the cost of BIM software is relatively small in comparison to total BIM investment. However, it can still be costly and become an obstacle for BIM adoption. Furthermore, incompatibility problems (file formats/standards/versions) in BIM can provide serious obstacles. Therefore it is worthwhile considering the following as potential challenges for BIM:

- *Cost of Licence:* This involves the cost of the software application licence.
- *Interoperability:* This involves the compatibility of software applications for collaboration and communication.

Hardware: it is commonly accepted that BIM applications face sluggish software performance and place higher demand on computer resources. Therefore, it is worth identifying the appropriate hardware specifications for running BIM applications. The following are hardware related challenges:

- *Hardware requirement:* the demand for computer resources
- *Cost of Hardware:* cost of the appropriate hardware specification needed for the requirements of BIM application software.

Network: one of the key features of BIM is distributed collaboration and information sharing which also requires sufficient networking infrastructure and facilities. Thus, it is worthwhile considering network mediums and facilities for BIM adoption.

- *Exchange Medium:* this entails the sufficiency of data exchange mediums with other stakeholders
- *Internet facilities:* This encompasses issues such as broadband speed and efficiency Internet connectivity.

8.2.3.2 Process Set

Infrastructure: this is a challenge looking at how the infrastructure of architectural firms affects the uptake of BIM. This entails the maintenance of the infrastructure and the setting up of facilities.

- *Maintenance of infrastructure*
- *Setting up the facilities*

Product and Services: This shows the extent to which feature rich BIM is integrated in the project model. It contains the plan details, 3D views, the level of understanding and an appreciation of the value given to the information available via communication and collaboration.

- *High level of detail required for the BIM product*
- *Cost of services involved for the BIM product*

Human Resources: this can be the most crucial component within the challenges relating to the process as it is about the technical know-how of employees, their competency and knowledge about BIM and BIM products. Human resources departments require significant time and cost investment for capacity building.

- *The technical know-how of staff*
- *The staff's knowledge of BIM products*

Leadership: this encompasses the competence of a firm's leadership when adopting a BIM culture within a firm. For successful BIM adoption and use, visionary leadership, especially at the executive management level, is critical. Absence of such leadership can be a strategic challenge for BIM.

- *Leading figure for management*
- *Cost of sustaining the leadership*

8.2.3.3 Policy Sets

Regulatory: this relates to the challenges concerning regulatory guidelines and standards for BIM which are, generally, lacking although the UK Government is introducing guidelines and standards in accordance with the BIM maturity levels.

- *Lack of BIM guidelines*
- *Lack of policy to implement BIM*



What do you want to do?

No matter what you want out of your future career, an employer with a broad range of operations in a load of countries will always be the ticket. Working within the Volvo Group means more than 100,000 friends and colleagues in more than 185 countries all over the world. We offer graduates great career opportunities – check out the Career section at our web site www.volvogroup.com. We look forward to getting to know you!

VOLVO
AB Volvo (publ)
www.volvogroup.com

VOLVO TRUCKS | RENAULT TRUCKS | MACK TRUCKS | VOLVO BUSES | VOLVO CONSTRUCTION EQUIPMENT | VOLVO PENTA | VOLVO AERO | VOLVO IT
VOLVO FINANCIAL SERVICES | VOLVO 3P | VOLVO POWERTRAIN | VOLVO PARTS | VOLVO TECHNOLOGY | VOLVO LOGISTICS | BUSINESS AREA ASIA

Download free eBooks at bookboon.com



Click on the ad to read more

Contractual: this concerns contractual challenges that can be a barrier to BIM adoption. These include the issues of sharing risks and responsibilities in a BIM product, client understanding and recognition of BIM and, subsequently, if BIM is the requested way of working methodology in construction projects, for example, the UK Government's demand, as a client, for BIM is a 'push' factor for the construction industry to adopt BIM, the potential contractual related challenges are:

- *Client recognition of BIM as part of contractual issues*
- *Risks involved in the BIM culture*

Preparatory: this concerns the cost of staff training and up-skilling in BIM and how to gain improvement in the areas of information/knowledge management and digital technologies. An absence of such preparatory plans may result in a lack of success in BIM usage.

- *Lack of training/awareness of BIM*
- *Cost of training of staff*

8.2.3.4 People and Culture Sets

Innovation: innovation related issues could prove to be a challenge for BIM; that is to say, that no innovative achievements would be possible without the right people on board. Recognizing that BIM is the new frontier in the AECO industry, the challenge of finding and nurturing the right team of people is an ongoing challenge. Listed below are the sub-themes or parameters of this challenge.

- *Conservative attitude of professionals*
- *Resistance to change*
- *Fear of "new" roles & responsibilities*

Management: transition to a BIM-enabled work environment requires considering the socio-cultural environment as well as the physical and technological environment; this would be very challenging without strong leadership. Therefore, a visionary leadership at top level is a must for BIM. In addition, working in a BIM-enabled project creates the clichéd question "who owns the model?" Without having stated administrative management roles and responsibilities, a lack of clarity concerning BIM product ownership remains a challenge for BIM. This topic is further elaborated upon and discussed in section 6.

- *Leading figure for management*
- *BIM product ownership*

8.2.3.5 Market Place Sets

Clients: this concerns the client's attitude to, and appreciation of, BIM. To some extent, the client's perspective and requests can be a challenge for BIM. Some client related issues are exemplified below.

- *Client expecting 'more for less'*
- *Cost of sustaining the leadership*
- *Cost of resources involved*

Demand: a lack of demand by the clients in the market for BIM (i.e. a lack of a push strategy), the competition in the market, and the issue of clarity as regards profit making via BIM usage, can be also be challenges. If no clear critical sustainable competitive advantage is envisioned by companies which compete in the market (a lack of pull strategy), it can be a challenge for BIM. These challenges are listed below.

- *Lack of client's demand for BIM*
- *Lack of market competition*
- *Lack of clear profit in using BIM*

8.3 A review of the report "rethinking construction"

A review of Egan's report entitled "*Rethinking Construction*" was carried out by a Government Review team and the review was published: "Never Waste a Good Crisis" (Wolstenholme et al., 2009). The review aimed to see whether the principles behind the Egan agenda remained relevant a decade after its publication. And the review concluded that, while some of the ideas need to be updated, the need for change is as strong today as it was eleven years ago when the 'Rethinking Construction' report was published in 1998. The main issues highlighted in the 'Rethinking Construction' report (Egan, 1998) were as follows:

- Excessive capital costs
- Excessive construction time
- Lack of predictability
- Unacceptable levels of defects
- Excessive number of accidents
- The lack of productivity
- The low levels of profit

As explained in section 3, the 'Rethinking Construction' report (Egan, 1998) set out five key drivers for change, four key project processes and seven targets for improvement in the construction industry. These targets were reviewed by Wolstenholme et al. (2009), as illustrated in figure 8.2 below.

How have we done against Egan’s targets?



Figure 8.2: How have we done against Egan’s targets? (Wolstenholme, 2009)

What is clear from the findings is that the targets of reduced cost, reduced construction time and reduced predictability are not being achieved, while the targets of reduced defects and reduced accidents are only partially being met. BIM offers a new way of addressing all of these targets.



“Up to 30% of construction is rework, labour is used at only 40–60% of potential efficiency, accidents can account for 3–6% of the total project costs, and at least 10% of materials are wasted. These are probably conservative estimates. The message is clear: there is plenty of scope for improving efficiency and quality simply by taking waste out of construction” (Latham, 1994).

The review identified some key ‘blockers’ as to why the construction industry cannot make the expected progress. These are listed below.

8.3.1 Business and Economic Models

Business and economic models in the construction industry determine the pace of change and the following factors, relating to both business and economic models, create a downward spiral preventing the industry from progressing:

Lack of Cohesive Industry Vision: A lack of joined-up thinking in the industry and at Government level concerning how the built environment contributes to the UK’s long-term prosperity and the aim of achieving a sustainable, low carbon economy.

Few Business Drivers for Improvement: For much of the supply chain, there are few businesses or economic drivers able to deliver meaningful change. The industry is prepared to accept stable, though unexciting returns, rather than attempt changes that are seen as being ‘too difficult’.

Construction ‘Does not Matter’: The low impact of construction costs and outcomes on a client’s business case means that in some sectors construction ‘does not matter’.

No Incentives for Change: Most client business models are focused on short-term gain and do not reward suppliers who can deliver long-term sustainable solutions.

Construction is seen as a Commodity Purchase: Too many clients focus on the upfront costs of construction, rather than on the value created over the lifetime of an asset. Few suppliers, other than those involved in PFIs, have any continuing interest in the operation of the building and, therefore, no incentive to raise quality standards.

Industry Culture is Driven by Economic Forces: Even where clients plan for the long-term, few have avoided cuts during the current downturn. Many clients and suppliers appear to have abandoned partnering behaviour (if they ever had adopted it in the first place) and returned to transactional relationships.

8.3.2 Capability

It is necessary to attract, retain and develop more of the right people to improve industry capability. The review team highlighted that there are factors which together relate to industry capability and which lead to a downward spiral that prevents progress:

Lack of Visible Leadership: The industry lacks sufficient leaders who can communicate their vision and engage employees to think about the value of their input beyond their tactical horizon. A lack of visible leaders results in a low profile and a poor industry brand.

Failure to Attract New Talent to the Industry: The industry's poor image means that it does not attract sufficient high quality, highly motivated graduates, nor do we promote our industry effectively to women and members of ethnic minorities.

Narrow Degree Courses Prevent Holistic Thinking: Instead of developing students to think holistically about how to create integrated built asset solutions, universities continue the industry model of separate disciplines and are restricted by the need to align with professional accreditation routes.

Failure to Develop Talent within the Industry: Inferior graduate development programmes and the 'permafrost' of middle managers results in a brain drain both overseas and to other industries. Leadership training at all levels of the industry is inadequate, particularly for junior leaders and supervisors.

Lack of Purpose: The industry lacks a clear mission, based on a strong ethical stance, for the contribution it makes to society. As a result, it struggles to present an effective image to the public and Government.

8.3.3 Delivery Model

A lack of integration in the delivery process obstructs continuous development. The following factors together create a downward spiral that prevents the use of effective delivery models:

Few Clients Demand a Best Value Solution: Clients struggle to articulate what value means to them, and too few projects develop a clear brief that defines their business, social and environmental requirements. Clients are unaware of the potential value that integrated supply chains can bring and fail to engage them early enough, relying too often on consultants specifying traditional solutions through dated procurement methods.

Lack of an Integrated Process Results in Sub-optimal Solutions: Designers are appointed in isolation. Contractors are engaged late and with a focus on the lowest price. Facilities management and operational integration are rarely considered at the design stage. As a result, there is a failure to develop a fully integrated design that reflects the whole lifecycle of an asset.

Contractors would Rather ‘Push’ Risk down the Supply Chain than ‘Pull’ the Opportunities Back Up: Contractors’ mind-set in procurement is to pass risk down the supply chain, rather than to draw up opportunities to create value by working as an integrated team.

8.3.4 Industry Structure

The diverse and fragmented structure of the industry creates competing agendas. The Review Team also addressed some factors relating to the industry infrastructure which cause a downward spiral preventing the industry from progress:

Lack of a Single, Coherent Voice for the Industry: Not only are the key messages from different industry bodies diluted, they are often contradictory.

Lack of Joined-up Thinking by Government and Other Key Stakeholders: Government struggles to combine its roles of chief client and industry regulator, and divides responsibility for the built environment amongst too many departments. This results in a complex and confusing set of policies, initiative overload and a lack of understanding amongst wider stakeholders.



Too Many Industry Bodies: The complex industry structure sits in silos and too many industry bodies make it hard to see the bigger picture. Having at least five relevant sector skills’ councils is an example of this and hampers a broader and more strategic understanding of the built environment. Institutions are too focused on preserving professional disciplines rather than on how to provide integrated best practice solutions for clients. Similarly, trade associations focus on transactional issues within their own technical specialist silos.

It can be summarised from the review that, despite some improvements, the construction industry is still experiencing problems which are mainly due to its method of operation. These are illustrated in figure 8.3 below for brevity.

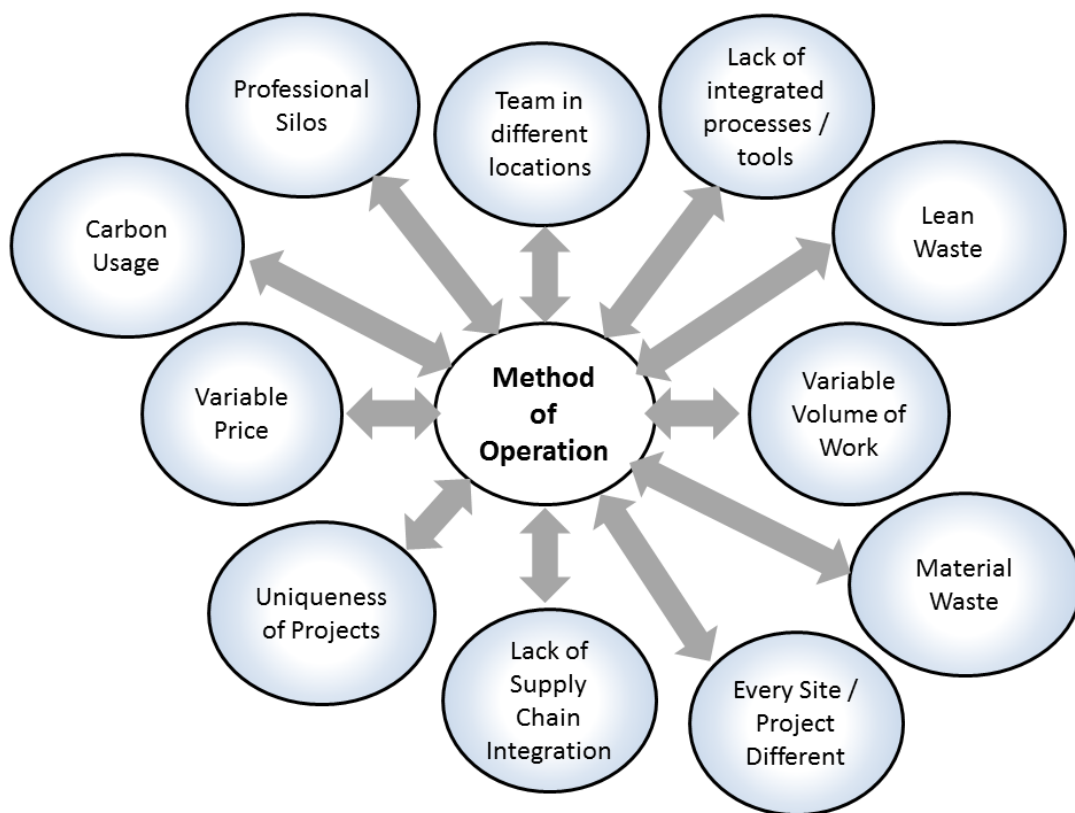

Figure 8.3: Construction industry challenges being experienced due to its method of operation.

8.4 UK government's vision for construction industry by 2025

Most recently, the Construction 2025 report (HM Government, 2013) has set out a vision and targets for the construction industry. It presents a clear vision of where the UK construction can be in 2025 including the following key features

- **People:** An industry that is known for its talented and diverse workforce, attracting and retaining a diverse group of multi-talented people, operating under considerably safer and healthier conditions, which has become a sector of choice for young people inspiring them to enter into rewarding professional and vocational careers.
- **Smart:** An industry that is efficient, technologically advanced, and leading the world in research and innovation, transformed by digital design, advanced materials and new technologies, fully embracing the transition to a digital economy and the rise of smart construction.
- **Sustainable:** An industry that leads the world in low carbon and green construction projects, becoming dramatically more sustainable through its efficient approach to delivering low carbon assets more quickly and at a lower cost, underpinned by strong, integrated supply chains and productive long term relationships.
- **Growth:** An industry that drives and sustains growth across the entire economy by designing, manufacturing, building and maintaining assets which deliver genuine whole life value for customers in expanding markets both at home and abroad.
- **Leadership:** An industry with clear leadership from a Construction Leadership Council that reflects a strong and enduring partnership between industry and Government.

It is believed that this vision can provide the basis for the industry to exploit its strengths in the global market and, that by 2025, construction will be radically transformed. Added to the vision above, it sets the targets as presented below in figure 8.4.

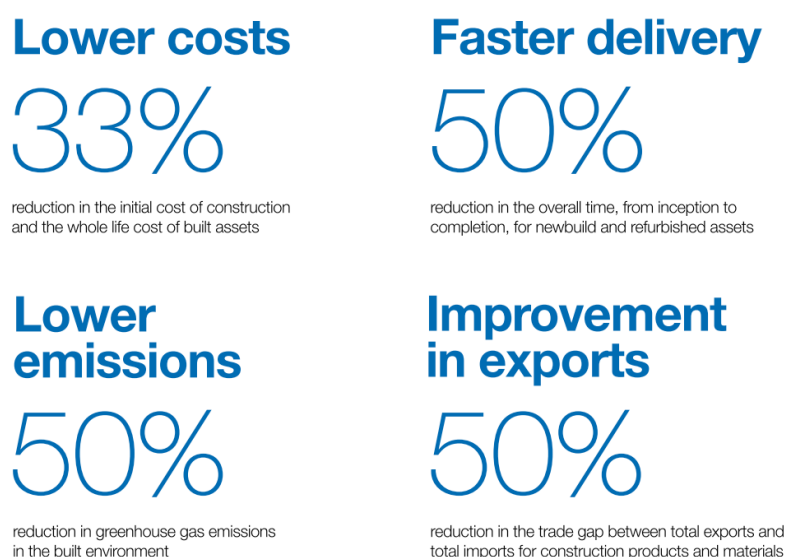

Figure 8.4: Government targets for the industry by 2025 (HM Government, 2013)

8.4.1 Drivers for Change

To deliver these strategic targets fundamental changes are required in the way the construction industry operates. Responsibility to implement such changes rests upon the entire supply chain and the Government has an important role to play. The key drivers of change that can deliver the vision of an industry with a reputation for world leading efficiency (and for attracting and retaining the people needed) are defined as:

- Improved image of the industry
- Increased capability in the workforce
- A clear view of future work opportunities
- Improvement in client capability and procurement
- A strong and resilient supply chain
- Effective research and innovation.

Although these drivers are not explained in detail in this document, the last point about effective research and innovation is worth elaborating since it is highly relevant to the context of the workbook.

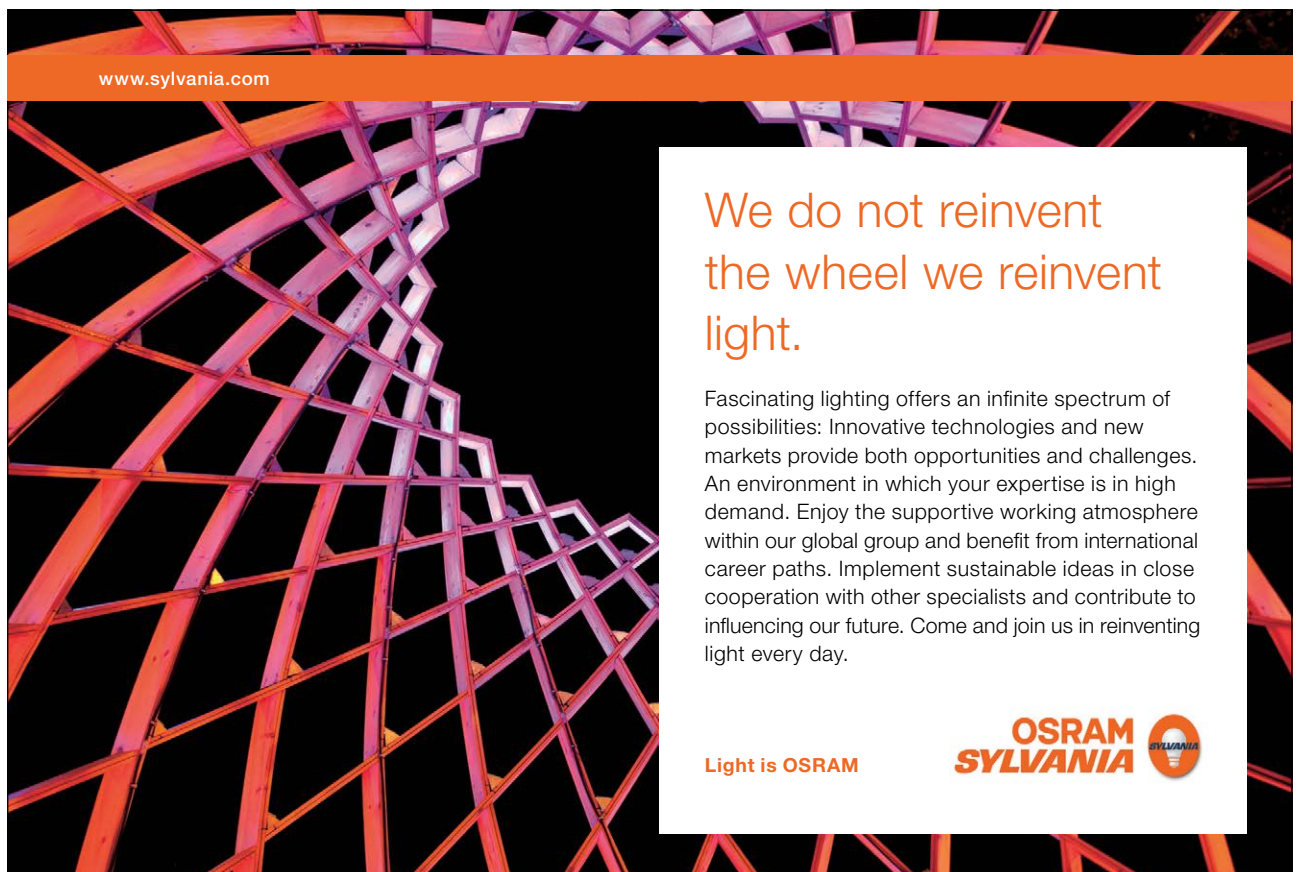

www.sylvania.com

We do not reinvent the wheel we reinvent light.

Fascinating lighting offers an infinite spectrum of possibilities: Innovative technologies and new markets provide both opportunities and challenges. An environment in which your expertise is in high demand. Enjoy the supportive working atmosphere within our global group and benefit from international career paths. Implement sustainable ideas in close cooperation with other specialists and contribute to influencing our future. Come and join us in reinventing light every day.

Light is OSRAM

OSRAM SYLVANIA 



8.4.1 Effective Research and Innovation

Under this driver of effective research and innovation, the report highlights on two key interlinked domain research and innovative results that can have positive impact on the construction industry performance. These are green construction and smart construction & digital design, and, naturally, it is stressed that BIM has a part to play in the latter.

The report addresses the joint industry and Government Building Information Modelling (BIM) strategy which is beginning to show the transformative potential of digital techniques in construction. It justifies BIM as a way for companies to make more intelligent use of data, which enables waste to be eliminated from the construction process and the report highlights the related regulations that, by 2016, all Government construction projects will prescribe the use of BIM level 2, irrespective of project size.

The BIM Task Group, driven by industry and supported with £4 million of Government funding, has led the implementation of the BIM strategy. As an example, collaboration with the Ministry of Justice has demonstrated significant savings in the design and procurement stages, with the £20 million Cookham Wood prison reporting an 18% saving through the effective use of BIM.

The review report draws a further vision for the years between 2016 and 2025 wherein the UK Government and industry will move to Level 3 BIM, which, it is planned will be deeply embedded in the wider digital economy. This would require the further development of technologies and commercial models, and promises enormous benefits by delivering fully transparent data sharing capabilities across the supply chain. Industry and Government must commit to the Level 3 agenda in order to fully realise BIM's potential.

Furthermore, the report states that the availability of digital information would also enable more effective design for manufacture and assembly. This would make offsite construction solutions, which are often excluded by current procurement practices, more readily applicable in the future.

8.5 Barriers to BIM implementation

While BIM is seen as a new working methodology for the building industry, it encounters barriers in its implementation as its implementation into the complex AECO is not straightforward.

In order to turn BIM into a default delivery method, attitudes within the Architectural, Engineering and Construction (AEC) industry need to change: for example, the initial focus at the design stage should be on the operational lifecycle cost as opposed to the initial capital cost incurring in design and construction.

Having a data rich BIM model that enables information extraction directly into a facility management tool would be a desirable deliverable. However, current limitations in software means that a fully integrated BIM model is a future vision at the moment due to interoperability issues and these will continue to provide a barrier for the integrated approach that denotes the Government's BIM Level 3 approach.

McAdam (2010) highlighted that BIM implementation itself will raise concerns on the commercial, technical and legal issues of i) Process, ii) Interoperability, iii) Use of model, iv) Status of the model, v) Cost of BIM process, vi) Design liability, vii) Design delegation, and viii) Ownership and protection of data. These are further elaborated upon below.

8.5.1 Interoperability and exchanging data

Interoperability is the ability to manage and communicate electronic product and project data between collaborating firms and within individual companies' design, construction, maintenance, and business process systems. Hence, addressing interoperability between systems will play a key role in helping to streamline the building lifecycle process and to enable owners to reduce lifecycle costs and develop more effective and sustainable operational workflows.

Some best practice projects adopting BIM have shown that the use of interoperable building information models will:

- Speed informed design decision-making
- Permit rapid iteration of simulations of building performance and construction sequencing
- Streamline information flow and reduce time-to-complete in certain supply chains
- Substantially reduce field problems and material waste during construction
- Make feasible the off-site fabrication in controlled environments of larger percentages of the building components and assemblies, increasing their quality and longevity, and
- Reduce on-site construction activities and materials' staging, creating a less crowded and safer site.

These benefits are all via the use of interoperable information exchange and will enable information sharing and handover from AEC to FM for sustainable and cost effective operation and maintenance.

Greater interoperability will be supported through the use of COBie and IFC which are the two open standards which have been developed to reduce the cost, and improve the quality, of building information handover.

Despite the fact that the development of IFC and COBie supports interoperability, the projects that use these standards can face constant challenges from the fact that software vendors regularly release new updates of their proprietary packages on a frequent update cycle. This can affect the development of third party applications and open standards supporting BIM applications. Furthermore, firms may have to upgrade their BIM data to support current versions as vendors do not support backward compatibility between applications as applications are becoming more intelligent.

8.5.2 Model contents and their contractual status

Another challenging aspect is to specify the data needed for inputting into the BIM model and the data required for exporting from the model. Hence, clients should be involved from the outset of the design process. In addition, by being involved in the inception of a project, clients can specify and verify what data within the model BIM should be used for operations and maintenance, and capital improvement planning, or for input into a Building Automation System (BAS) for building performance analysis. This would help establish a shared understanding between the project teams in order to capture the correct information at the right time.

On the other hand, while the contract documents are in 2D, if a project is completed with BIM, this can create some potential for complexity and conflict, for example, the BIM model may encapsulate more information than that required by the intended use of the client. In such a case it would be ideal to provide the BIM model with a legal status (Teicholz, 2013).



360°
thinking.

Deloitte.

Discover the truth at www.deloitte.ca/careers

© Deloitte & Touche LLP and affiliated entities.



All parties should agree on that what should and what should not be involved in the BIM model based on a legal contractual agreement in order to avoid any congestion with unnecessary and/or overloaded information, which can lead to cost and efficiency related drawbacks.

8.5.3 Model Ownership

The issue of conflicts and problem identification can be successfully resolved earlier in the process if BIM is commenced early in the design together with client involvement and if it is consistently used throughout the design and construction.

Thus, owners should identify clear roles and responsibilities and methods and communicate them with the project team (Eastman et al., 2011). This could be via a responsibility matrix for information production that forms part of the BEP (BIM Execution Plan) produced by the Construction Project Information Committee (CPIC) which would state that “it is important to define who models what and to what Level of Detail (LOD)”. Therefore, who models what and to what extent should be clarified in the EIR (Employer Information Requirements) and documented in the BEP of model ownership and component information (CPIC, 2013).

While some insist that the model owner should be the client due to contractual agreements in relation to FM tasks and duties during the life of a building, some others, such as Penn State University (PSU, 2013), argue that the creator of the information retains the ownership of the data and this, thus, limits its re-use and reliability. This would protect the model owner’s intellectual property and limit the liability between the contracted parties.

PSU (2013) addressed two questions in relation to the model ownership regarding an owner being able to re-use the information through the lifecycle of the facility. These are:

- 1) whether or not the owner can claim ownership of all the information created during the design and construction phases for use downstream for the renovation and FM requirements through the life of the facility, or
- 2) if the owner can claim the right to re-use the information created in the design and construction phases through obtaining a licence to use the information for renovation or FM requirements.

Therefore, these concerns should be outlined and detailed in the contract with the architectural team to address model ownership or the licencing for permission to use the model for renovation or FM requirements (Teicholz, 2013).

8.5.4 Intellectual Property Ownership

As aforementioned, the issue of model ownership can lead to a subsequent concern over Intellectual Property Rights (IPR). Since it is closely coupled with the model ownership issue, the IPR issue also concerns all parties. In other words, owing to multiple stakeholders developing and/or contributing to the integrated BIM model/s the AEC teams and the client will be very protective of their Intellectual Property Rights. However, as BIM's true value is realised in the management of the asset through its lifecycle, clients could be willing to use the BIM model for facilities management.

Again, a contractual licence agreed by all parties, permitting the limited use of the model by another party while maintaining IPR can be the way forward.

In short, from the client's point of view, it is important that the owner either owns the design or has a broad licence to use the design information to operate, maintain and upgrade the project facilities.

8.5.5 Increased Liability

The exchange of information via BIM through the design, construction and operations phases also raises the concern of liability which can also hinder the adoption of BIM (Teicholz, 2013). A key problem arising from BIM-based collaborative design and construction is the extent of legal liability for each party even if there is no contractual relationship. For example, from the design point of view, designers can be concerned about being drawn into disputes with owners and contactors who are also worried about being liable for certain design elements, particularly FM information from BIM which can be traced back to the design and construction phases (Teicholz, 2013).

Therefore, defining from the outset under what rights the client or other project members should use the project information is critical. There should be written legally binding appointment documentation in order that each party is clear on the intended use of the BIM model.

8.5.6 Insurance covering BIM related work

Where multiple parties (such as the contractor and the client) wish to reuse the designer's information in the BIM model, Professional Indemnity Insurers (PII) are, generally, very clear that they would not be happy to insure risk where there is open-ended liability (Wallbank, 2011). Hence, producing protocols that detail the recording of work stages based on industry accepted standards (such as BS 1192:2007) can allow insurers to understand the limits of usage of project team members' work. However, if the use of the information is multiplied, the insurer can charge extra for the members' insurance premium.

Therefore, Contractual and legal agreements can help facilitate the use of BIM by dealing with many of the bottlenecks that are met in BIM adoption (Eastman et al., 2011). Thus, if these contractual and legal issues can be addressed in the appointment document, they can assist in easing the usage of BIM. However, one can ask the following question: “Is there any standard for the appointment documents clarifying this ownership, IPR, model use and insurance concerns?” This could possibly be considered by the Government’s BIM Task Group for BIM Level 3 implementation.

8.6 References

Arayici, Y., Coates, P. (2013), “Operational Knowledge for BIM Adoption and Implementation for Lean Efficiency Gains”, *Journal of Entrepreneurship and Innovation Management*, 1 (2), 1–22.

Arayici, Y., Onyenobi, T., Egbu, C. (2012), *Building Information Modelling (BIM) for Facilities Management (FM): The Mediacity case study approach*, *International Journal of 3-D Information Modelling*, 1 (1), 55–73.

Arayici, Y., Khosrowshahi, F., Ponting, A.M. and Mihindu, S. (2009) *Towards Implementation of Building Information Modelling in the Construction Industry*, 5th International Conference on Construction in the 21st Century (CITC-V) “Collaboration and Integration in Engineering, Management and Technology” May 20–22, 2009 Istanbul, Turkey.

SIMPLY CLEVER

ŠKODA



We will turn your CV into
an opportunity of a lifetime



Do you like cars? Would you like to be a part of a successful brand?
We will appreciate and reward both your enthusiasm and talent.
Send us your CV. You will be surprised where it can take you.

Send us your CV on
www.employerforlife.com



Azhar, S., Nadeem, A., Mok, J.Y.N. & Leung, B.H.Y. (2008), Building Information Modelling (BIM): A New Paradigm for Visual Interactive Modelling and Simulation for Construction Projects, First International Conference on Construction in Developing Countries.

Constructing Excellence, (2009), Supply Chain Management, Constructing Excellence.

Construction Project Information Committee, (CPIC) (2013), Post Contract-Award Building Information Modelling (BIM) Execution Plan (BEP), www.cpic.org.uk/wp-content/uploads/2013/06/cpix_post_contract_bim_execution_plan_bep_r1.0.pdf

Eastman, C., Teicholz, P., Sacks, R. & Liston, K. (2011), BIM Handbook; A Guide to Building Information Modelling for Owners, Managers, Designers, Engineers, and Contractors, New Jersey: John Wiley & Sons.

Egan, J. (1998), “Rethinking Construction”, the Report of the Construction Task Force.

Khanzode, A., Fischer, M., Reed, D. (2008), [Benefits and lessons learned of implementing building virtual design and construction \(VDC\) technologies for coordination of mechanical, electrical, and plumbing \(MEP\) systems on a large healthcare project](http://www.itcon.org/2008/22), ITcon Vol. 13, Special Issue [Case studies of BIM use](#) pg. 324–342, <http://www.itcon.org/2008/22>

Haron, A.T., Marshall-Ponting, A.J. & Aouad, G. (2009), Building information modelling in integrated practice. in: 2nd Construction Industry Research Achievement International Conference (CIRIAC 2009). Kuala Lumpur, Malaysia.

HM Government (2013), “Construction 2025: Industrial Strategy, Government and Industry Partnership”, www.official-documents.gov.uk

Latham, M. (1994), “Construction the Team: Joint Review of Procurement and Contractual Arrangements in the UK Construction Industry”, HMSO, <http://constructingexcellence.org.uk/>

McAdam, B. (2010), “Building Information Modeling: the UK legal context”, International Journal of Law in the Built Environment, 2(3), 246–259.

McGraw Hill Construction, (2012), “The business value of BIM for infrastructure”, Smart Market Report, pp. 1–60.

Pennsylvania State University, (PSU) (2013), Building Information Modelling: Planning Guide for Facility Owners, accessed in 24/10/13, <http://bim.psu.edu/Owner/Resources/default.aspx>

Rundell, R. (2007), the Five Fallacies of BIM, Part 1 Cadalyst, [Online], <http://aec.cadalyst.com/aec/Column:+1-2-3+Revit/The-Five-Fallaciesof-BIM-Part-1-1-2-3Revit-Tutor/ArticleStandard/Article/detail/470107>

Suermann, P. (2009), "Evaluating the impact of building information modelling (BIM) on construction, PhD Thesis, University of Florida.

Teicholz, P. (Ed.). (2013). *BIM for Facility Manager*, Hoboken, New Jersey: John Wiley & Sons, Inc.

Wallbank, B. (2011), "BIM and Professional Indemnity Insurance", <http://www.archicadusersassociation.com/>

Wolstenholme, A., [Austin, S. A.](#), [Bairstow, M.](#), [Blumenthal, A.](#), [Lorimer, J.](#), [McGuckin, S.](#), [Rhys Jones, S.](#), [Ward, D.](#), [Whysall, D.](#), [Le Grand, Z.](#), [Guthrie, W.](#), [Davies, R.](#), (2009), "Never waste a good crisis: a review of progress since Rethinking Construction and thoughts for our future". London: Constructing Excellence



I joined MITAS because
I wanted **real responsibility**

The Graduate Programme
for Engineers and Geoscientists
www.discovermitas.com

Month 16
I was a construction
supervisor in
the North Sea
advising and
helping foremen
solve problems

Real work
International opportunities
Three work placements



9 Case Studies

9.1 Introduction

This chapter introduces some case studies of BIM usage within real construction practices. Each case study detailed below provides information on the project, the usage of BIM technology and the impact made by the use of BIM.

9.2 Case Study 1: A School Project in North-West UK

A School Academy project in north-west UK was the first superblock school under the new EFA Framework for UK School facilities. The school was designed to allow 950 new student places and was delivered on-time in June 2013 to a BREEAM 'Very Good' rating. The facility was constructed with the vision to inspire students to fulfill their potential; with large internal open spaces, first class IT facilities, and indoor and outdoor sports facilities. The design and construction of the project embraced collaboration between the client, contractor and designers to create ownership of a shared vision. It was the first facility delivered in England to meet the 15% cost and efficiencies required under the Educational Funding Agency Framework.



Figure 9.1: A 3D BIM view of the internal layouts shown to the building end users

The School Academy project used BIM technology as a design engagement tool throughout the design and construction of the school building project. The main contractor commissioned the use of BIM technology to provide clear 3D visualizations for all project stakeholders. This allowed the end users to engage more fully with the design development and to influence the design before it was set.

The visualizations created included external views of the project and internal spaces such as classrooms and the main building atrium. The design team used BIM visualizations to plan and demonstrate the proposed design and layout of the furniture, fixtures and equipment. This allowed a clear understanding to be gained by all the parties before the final design was crystalized. Halfway through the project, a change in the construction programme took place, in that it was decided to create a new sixth form IT suite which led to changing the use of the learning spaces. However, the 3D BIM visualization of the suite helped students, governors, and the Head of Department to understand this new area and sped up the sign-off process. This significant change, which also required a revision of the building services' strategy, was included without affecting the programme date or the productivity of the site's construction management team. It was confirmed by the project manager that without the 3D BIM visualizations this change could have compromised the end date of the project.

BIM technology used in this project provided benefits for the end users, the design team and the construction management team. The proactive management of change provided benefits for the construction management team. Traditional pre-BIM practices would not have allowed the adoption of such a change, as requested by the client, so easily.

9.3 Case Study 2 – A Leisure Facility in North-East UK

In the north east region of the UK, in a leisure complex facility construction project, BIM was utilized to facilitate the efficient design, project planning and delivery of the facility. The complexity of the project provided the principle contractor with an excellent opportunity to implement BIM across a number of areas.



Figure 9.2. The external façade of the leisure complex facility

The project was a new high profile cultural facility, comprising a 13,500 seat entertainment venue complete with a 100-seat restaurant and 4000m² of public space. It is a world class venue that will host more than 140 events per year, including rock concerts, boxing matches, comedy shows and ice dancing. A fan-shaped retractable seating arrangement allows perfect views of the stage from every seat.

The building structure comprises a 3,500 tonne complex steel frame which includes a 45 meter long proscenium beam. A multi-skinned envelope and a double layered acoustically sealed roof prevent noise disturbing nearby residents. The front elevation of the building changes colour dependant on the show being performed in the building.

BIM was used in the project for the design of the building's geometric structure in 3D which allowed the client and the construction team to fully understand the project at an early stage. 4D BIM project planning was used with the graphical model which was developed to show planned versus actual project delivery. Alongside the 4D BIM project planning capability, logistics' planning and equipment movement on site was also produced. This provided an excellent benefit for the construction site team since the project was situated on a city centre location with limited space. As the project was designed and constructed using the 3D BIM model, the construction site team was able to liaise with the design team to mitigate potential health and safety risks.

ie business school

#1 EUROPEAN BUSINESS SCHOOL
FINANCIAL TIMES 2013

#gobeyond

MASTER IN MANAGEMENT

Because achieving your dreams is your greatest challenge. IE Business School's Master in Management taught in English, Spanish or bilingually, trains young high performance professionals at the beginning of their career through an innovative and stimulating program that will help them reach their full potential.

- Choose your area of specialization.
- Customize your master through the different options offered.
- Global Immersion Weeks in locations such as London, Silicon Valley or Shanghai.

Because you change, we change with you.

www.ie.edu/master-management | mim.admissions@ie.edu |

Download free eBooks at bookboon.com



Click on the ad to read more



Figure 9.3: A 3D BIM Model of the building structure



Figure 9.4: Actual building structure of the high profile cultural facility

3D BIM clash detection software was implemented throughout the design phase of the project and was carried out by an on-site BIM coordinator. The main contractor stated that BIM helped to save over £500,000 by identifying clashes/risks at an early stage allowing them to integrate the supply chain with the design and site team. The total number of clashes found by using BIM on the project was more than 250 clashes.

Financial constraints on the project were tight, but BIM helped the team sort out mistakes before they went on site, saving time and money. In the first four weeks, they found 62 clashes which would have cost £100,000 if they had been built. Subsequent clash detection saved even more. BIM also helped improve safety by allowing the team to visualize potential problems and take action. It was possible to see where to put guard rails in when working at height and plan how to access. Some of the team members had never worked in 3D or with BIM before. However, they quickly saw that the project would be impossible without it. Without 3D modelling and BIM, there was no way they could have designed the facility, let alone constructed it. The project team modelled every bolt. No downside in using BIM was highlighted by the project team.

The impact and benefits of utilising BIM in this leisure facility project have been significant for the project, the design team, the site management team and the supply chain. On the other hand, the one drawback of using BIM in the project was the overall cost of implementation. The additional costs to the principle contractor were over £750,000 in comparison to traditional 2D design methods.

9.4 Case Study 3 – A Campus Building Project

A new campus building project at a University in the north-west region of the UK is being undertaken to form a new home for the Schools of Music, Performance, Architecture and Art and Design. The building will contain a new theatre, recording studios, performance rooms, café and specialist teaching space alongside workshops. The project is seven stories in height and consists of a concrete frame structure to the lower floors with a steel structure to the upper two floors on piled foundations. The roof space will consist of areas of planted green roof on membrane. The external elevations are mainly curtain walling with elements of brickwork and metal cladding. Extensive external works will form a large public realm area adjacent to the building for external performances. The new entrance way through the centre of the building will be seen as a new entrance onto the University campus.



Figure 9.5: An external model view from outside the campus building project

The project is utilizing BIM technology to produce 3D BIM models. The 3D BIM models are developed collaboratively by all the members of the design team, each of whom produces an individual BIM model. The BIM modelling is continually coordinated and updated by the on-site BIM coordinator from the principal contractor. In the project, during the construction phase, the design is continually being developed. The BIM coordinator has the role of coordinating the Revit models from the architect, the structural engineer, the MEP designer and the sub-contractors when required.

The project also uses 4D BIM planning techniques to assist with project planning and progress monitoring. Figure 9.6 shows an image displaying images of the 4D BIM planning methods within the construction site offices.



"I studied English for 16 years but...
...I finally learned to speak it in just six lessons"

Jane, Chinese architect

ENGLISH OUT THERE

Click to hear me talking before and after my unique course download



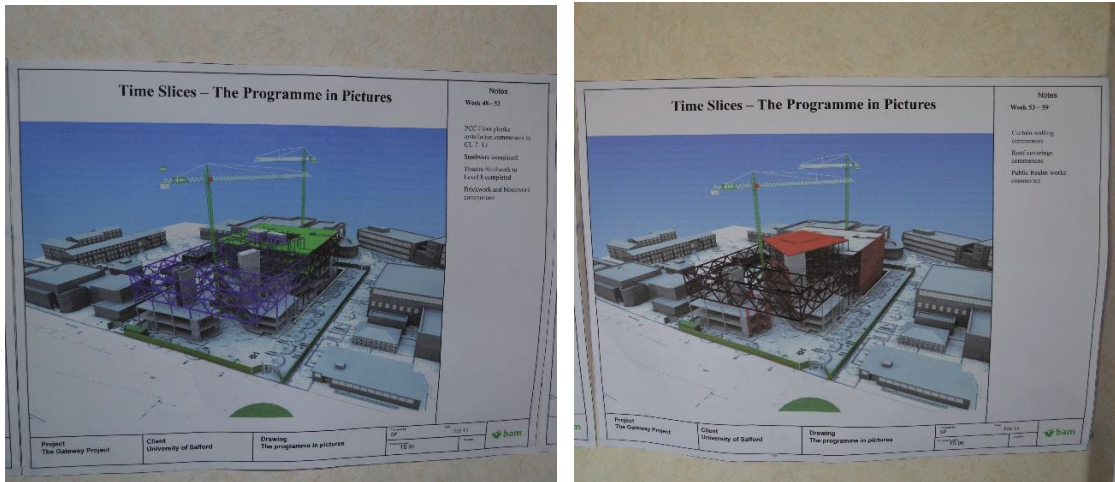

Figure 9.6: Use of BIM in 4D planning in the campus building project

Figure 9.7 shows an image taken from the project site offices of the 3D BIM model displayed for all project participants to view. This assists with project visualizations for all the project participants and the project stakeholders.



Figure 9.7: Print-outs' images taken from the 4D BIM model

Clash detection software is being utilized in the project design and the construction by the BIM coordinator to make the whole project more efficient. In the project, it has been recorded that clash detection software has resolved over 200 design clashes that would have been apparent on site. Figures 9.8 and 9.9 show two typical examples of where BIM clash detection identified clashes between the M+E design and the building fabric.

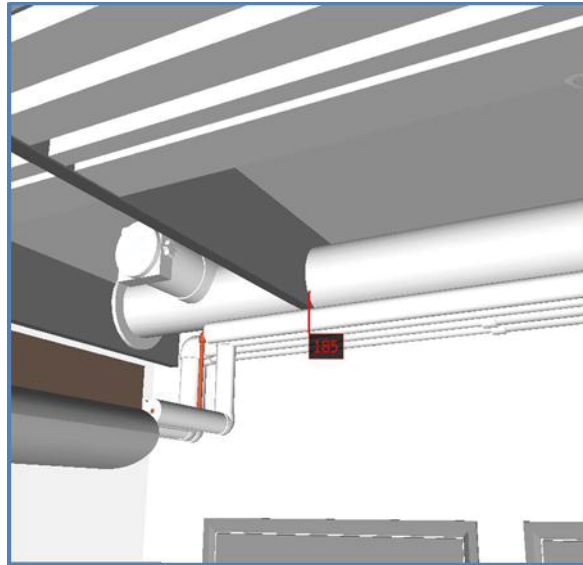

Figure 9.8: M+E Pipework clashing with acoustic baffles highlighted by clash detection



Figure 9.9: M+E water tanks clashing with structural concrete column highlighted by clash detection

The project is finding that, by using BIM, 4D planning allows 3D mark-ups to be produced for the meetings where progress is reported. In traditional practices a Gantt chart or a bar chart programme would have been used. Additionally, using 4D BIM planning and monitoring, the information produced is more visual allowing for effective communication and better decision making.

With BIM usage, the coordination of the M+E services with the building fabric occurred a lot earlier in the process than with traditional practices. This then allows more time for different or adapted designs to be produced; for example, the project team was able to model the builders' work holes around the M+E design which allowed greater control of the partitioning contractor and issues such as oversized holes and, subsequently, provided savings in elements such as fire stopping.

Clash detection is also being carried out at the construction stage of the project and the use of clash detection picked up over 200 vital clashes within the design before the application of the relevant work packages on the construction site; for example, the electrical distribution boards did not fit into the service risers correctly and this issue was resolved before the scheduled installation of the electrical distribution boards.

9.5 Case Study 4: A University Campus Building Project

In a university campus building project in the north-west region in the UK, the principle contractor provided BIM-based coordination across all the project stakeholders. The technical difficulty in the construction of the building and early involvement in the scheme design provided the main contractor with a unique opportunity to implement BIM throughout the design and construction. This process involved taking 2D drawings provided by other consultants and translating them into a 3D model of the research facility. The model will be used across the building's lifecycle to improve its efficiency and performance.

Excellent Economics and Business programmes at:



university of
 groningen



**“The perfect start
 of a successful,
 international career.”**

CLICK HERE
 to discover why both socially
 and academically the University
 of Groningen is one of the best
 places for a student to be

www.rug.nl/feb/education





Figure 9.10: A flying view from outside the building model (University campus project)

3D BIM modeling, 4D planning techniques, clash detection and BIM 360 were implemented across the building project. The level of development of the model was LOD 400. This level of development was also considered suitable for fabrication and assembly. The MEP contractor on the project was able to produce modular MEP units for off-site fabrication using the BIM model. The five storey building comprises cleanroom facilities, laser zones, optical, meteorological and chemical laboratories, seminar rooms, offices and ancillary accommodation.



Figure 9.11: 3D visualization from an internal view (University campus project)

Clash detection methods were used in the project and highlighted over 700 potential clashes that would have had to have been resolved on site if traditional, non-BIM methods had been used. During the M+E installation from the lower ground floor to the second floor, no clashes were apparent on site. During a typical, traditional practice of M+E installation over four floors over 50 clashes would be apparent from the design information when constructed on site. Figures 9.12 and 9.13 show snapshots from the project taken from the BIM model in Navisworks.



Figure 9.12: An image of the M+E and partitioning installed

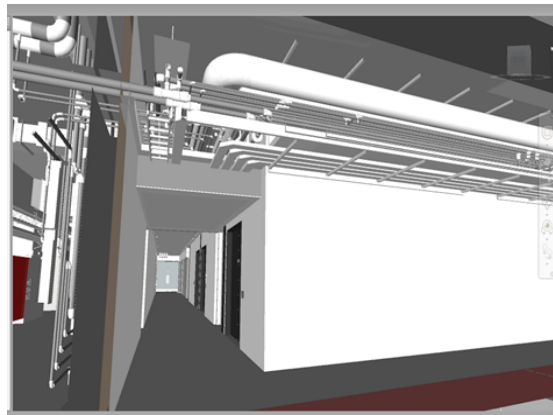

Figure 9.13: 3D BIM model showing the M+E and partitioning design

BIM 360 field software usage was trialed in the project. The feedback and comments from the BIM 360 focus group in the project team was that the system provided huge benefits in the recording of information from site operations. The project team worked collaboratively through a BIM cave environment. It is evident from the case study that the benefits gained by using BIM on the project are clear. It was also confirmed by the professionals from the main contractor that the BIM usage prevented numerous barriers traditionally found by construction management teams. Due to the speed required in the project by the client, the cost of BIM implementation was already considered within the tender stage of the project. This could be deemed to be unfeasible on other different projects.

9.6 Elaboration of BIM Usage in the Case Studies

This section presents the BIM usage in the described case studies in a comparative way. Table 9.1 presents the four described case studies and how BIM assisted with the corresponding construction management tasks, while figure 9.14 illustrates the summative information in table 9.1 in a concept map to reflect the link between BIM capabilities and construction management tasks.

9.6.1 Project Planning

Project planning is a challenging task for managers in construction projects. Major delays can be caused by water-tightness issues and insufficient time to commission a building. It is fairly usual that the construction site work is not complete on time for the M+E to be commissioned correctly. Practitioners commonly underestimate how long some site works are to construct.

4D BIM planning, for example, in case study 3 was used and shared by displaying the printouts of the 3D VR models showing daily scheduled work progress in the site office meeting room. These printouts, for example, showed where the cranes were located, the access to the site, and marked-up construction work progress. The parts of the 3D image on the screen were grey for uncompleted work while the completed parts were highlighted in green. This 3D visualisation was compared to usual programme mark-ups.

Incoming services were picked up a lot earlier, as compared to traditional practice, since BIM assisted with the identification of where services will and will not fit through service openings formed in the concrete structure. However, the construction management team members in the case study 3 building project highlighted that it would be useful if the mobile BIM concept was utilised with an iPad that would allow the site manager to walk around the site and mark up the progress of the M+E services being installed.



American online
LIGS University
is currently enrolling in the
Interactive Online **BBA, MBA, MSc,**
DBA and PhD programs:

- ▶ enroll **by September 30th, 2014** and
- ▶ **save up to 16%** on the tuition!
- ▶ pay in 10 installments / 2 years
- ▶ Interactive **Online education**
- ▶ visit www.ligsuniversity.com to find out more!

Note: LIGS University is not accredited by any nationally recognized accrediting agency listed by the US Secretary of Education. More info [here](#).



Despite the principle idea of marking up the progress on the model, the model has to be broken down; for example, the structural engineer may build their model with their columns from the ground floor continuously up to level four, but the actual construction of the columns would not be in the same style as structural engineer models them. In fact, columns in real construction are poured from ground to first floor and then it continues floor by floor.

CM Challenge	BIM capability	Case Study 1	Case Study 2	Case Study 3	Case Study 4
Project Planning	4D BIM planning and logistic tools	Not used	Used in the pre-construction planning phase and throughout the construction period	4D BIM planning techniques used to display the sequence of construction works	4D planning techniques used. Individual example of benefit of BIM for roof plant and steel work
Management of Sub-contractors	3D visualizations, collaborative design, 4D planning and logistic tools	Not used	Used to provide logistics' planning and equipment movements' schedules for works on site	4D BIM progress mark-ups produced to give visual representation of when a sub-contractors' works completed	Collaboration between all parties on the project with design responsibility utilizing the BIM Cave principles and tools
Project Information	3D BIM modelling, collaborative working, up-to-date information at the work face	Not used	Utilized to facilitate efficient design, project planning. Used to "build the arena twice" and provide efficiency throughout	Using BIM modeling for greater collaboration between the parties, particularly with M+E	BIM models at LOD 4 produced and used for fabrication of M+E modular units providing efficiency in construction methods
Monitoring the Construction Process	4D planning techniques, Progress monitoring, BIM 360 Platform	Not used	4D project planning techniques developed to show planned vs actual progress for work activities	4D BIM Progress visualization used to report progress to sub-contractors and client team.	The progress of the BIM model defines progress of the design but no detail in hand
Design Clashes	Naviswork Clash detection, Collaborative 3D modeling	Not used	3D clash detection used, over 250 clashes detected worth over £500,000 saving	Over 200 design clashes were resolved with clash detection software	Significant benefits reaped by detecting 700 clashes
Design Change	3D BIM Visualization, 3D BIM Modelling	Assisted in faster client decision making and understanding	BIM 3D modelling used for the design of the structure for greater client understanding	Project client used BIM also to communicate changes	Unknown
Project coordination	4D Planning techniques, BIM 360 Platform, Collaborative design platform	Not used	4D BIM logistics planning provided benefits for the city centre site due to space limitations	Not known	Benefits reaped by the use of 3D visualization to coordinate subcontractors

Table 9.1: Brief comparison of the case studies

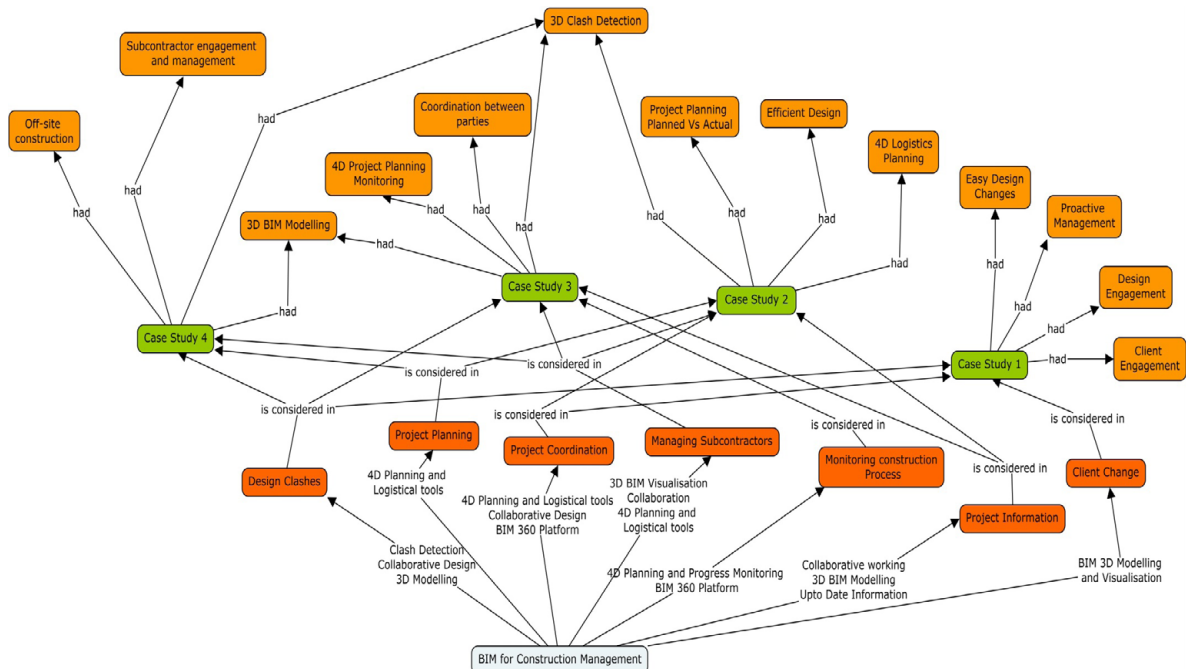

Figure 9.14: Concept map illustrating BIM capabilities experienced for the core construction management tasks in the case study projects

Thus, the actual BIM modelling sequence should also match with real practice to allow the construction programme mark-ups to be completed correctly. Since this is a lengthy process to complete, it is necessary for the designers to buy into this concept from day one when they commence building their models. This will then allow the construction team to highlight whether certain sections have been completed or not. Otherwise mismatches in the modelling and the actual construction progress will surely create problems and errors in the 4D planning which, subsequently, can diminish the usability and benefit of 4D BIM. Furthermore, such mismatches can lead to drawbacks when developing 4D BIM construction programming.

9.6.2 Clash Detection and Co-ordination

Clash detection was used in case study 3 for the concrete frame and the pre-cast stairs which needed modifications from the original drawings due to clashes with the dry riser pipework. Clash detection provided definite, positive and good planning. Many genuine clashes were identified early on that would have traditionally only been picked up on site when such clashes arose in the course of the building.

An important clash that was picked up was the steelwork coming out of a riser and the containment that needed placing above it. This would not have been picked up with the traditional 2D drawings and the clash would have only been apparent when constructed on site. Subsequently, this clash would have caused a major delay to the project as the acoustic performance within the theatre would have been jeopardised and would have been a major design problem. Identifying such clashes early on before they appear as an issue on site provides significant benefits by avoiding and rectifying the vast majority of potential problems at the design stage.

9.6.3 Communication with Sub-contractors using BIM

An early buy-in by all the parties is needed so that everyone has a clear understanding of the project and is able to detail builders' work earlier than required. This early buy-in by all is critical in reaping the benefits of BIM at the construction stage, e.g. the MEP design.

The MEP contractor should be on board from the day tendering starts in order to make the BIM model work so that bidding for the tender for a project is as a comprehensive team rather than a design sub-contractor joining later and having to work on a partially complete model. Therefore, in case study 3, the sub-contractors collaborated via BIM360 field software and they used 3D drawings on site as well as traditional 2D drawings. Builders' work holes, for example, were included in the model and the partitioning contractor was involved in the BIM modelling which led to a better control by the construction management team on issues such as fire stopping. This better control and coordination with the MEP provided the correct sizes for fine fitting and installation with no mess up; for example, the M+E usually asks for a builder's work hole of 1000 × 1000mm and then only installs a 50mm pipe through it.

9.6.4 Use of Information on Site via BIM

BIM usage on site can provide benefit in tight spots where bringing all the services in is a challenge (such as ductwork, all the containment and pipework). Although M+E installers use 2D drawings and install as per drawing, 3D BIM models are used for review when issues arise. The M+E installers and subcontractor supervisor can go around and check the installation on the 3D drawing or iPad (for which the BIM 360 iPad can be used) and zoom into the area and acquire information on the tight spots.

9.6.5 Quality and Monitoring of Work with BIM

Certainly with regard to design and knowing the progress of a sub-contractor’s design elements, it is possible to know exactly what has been designed and when. Regarding site work, BIM360 and the quality control documents prove to be very beneficial, such as signing-off walls from the partitioning contractor to the M+E contractor. With previously produced wall sign-off trackers, it was possible to know the duration of the works on the programme which can then be mirrored on site. Using BIM 360 would make the whole process much more efficient utilising a single source and point of information with notifications being sent to each party.

Wall sign-offs are, traditionally, very time consuming and contain large elements of paperwork, signatures, meetings and matrix solutions. However, when this information is held on an iPad, it is very efficient and straightforward. This would remove the need for daily meetings (as is common on previous projects) requiring all relevant sub-contractors’ attendance.

.....Alcatel-Lucent 

www.alcatel-lucent.com/careers

What if you could build your future and create the future?

One generation's transformation is the next's status quo. In the near future, people may soon think it's strange that devices ever had to be "plugged in." To obtain that status, there needs to be "The Shift".



9.6.6 Design Changes with BIM

Clients' experience with BIM within the 4 case studies was positive since BIM made each project more efficient. Similarly to clash detection, early engagement is a major factor. Although BIM was used for the concrete framing on site, issues were identified at the design stage such as unfit ceiling services in the voids. This was a major advantage in enhancing productivity and efficiency on site through an accurate design that is not prone to change during construction.

Off-site construction was made more accessible as the M+E contractor is able to send off the design earlier than usual in order to identify areas that could be made as modular units via off-site manufacturing. This speeds projects up, helping to gain time on the programme and making the whole process more efficient and productive.

Case study 4 was a difficult project with many challenges. With the mechanical and electrical elements of the building accounting for 50% of the whole project's value it was imperative that the building structure and fabric was co-ordinated with the services. The project stakeholders decided (during the concept design stage of the project) that BIM was to be utilised to a very high standard. The level of development of the BIM executed was at LOD (Level of Detail) 400 in the project.

The project was fully modelled in BIM and a clash detection tool utilised throughout the design. 4D logistical and planning facilities were also used. BIM 360 was employed during the construction by the site management team. Additionally, the client was strongly pushing for the use of the 3D BIM model to incorporate further details to allow for whole lifecycle costing in order for the facilities management capabilities to be utilised.

9.7 Disadvantages of BIM Use in the Case Studies

Information: If all the information that is required is not available from all the parties with design responsibilities the BIM model has flaws. The major design parties can produce the most detailed design that they can, yet if one party is lacking in providing the information required for some parts of the design, the whole design cannot be completed as the BIM model needs all the information from all parties to be successful.

Timing: The pace of case study 4 was the fastest project they had experienced (within their project management experience of many years) according to the project management team. As construction usually starts on site before the whole design and its BIM model is completed, more emphasis must be placed on designers starting the BIM model as soon as a project contract is awarded. This may allow the BIM model to be progressed faster in order to aid the construction management team even more.

Pattresses – Pattresses within the partition walls have not been detailed on the BIM model in case study 3. This means that remedial works have to be carried out to some of the partitions to insert pattresses where they are missing. These may have been installed if traditional 2D drawings had been used as a sole source of information. Thus, BIM models should ensure that pattresses are incorporated by the design team.

9.8 Advantages of BIM Use in the Case Studies

CM team members made it clear that the benefits of using BIM within case study 4 were astonishing. The negatives of using BIM were far outweighed by the benefits of BIM usage. The major benefits realised are:

Modular Units: the M+E contractor was able to review the BIM model for the areas of the installation through the use of modular units. The BIM model highlighted the technical straight runs of M+E install that were able to be manufactured, constructed and tested off-site and then transferred to the project site. Once the units were transferred to the site on the scheduled day of the construction programme, they were simply lifted into place, positioned and connected to the adjacent modules, and this made the installation complete.

The module installation took a week for a full corridor run while the traditional methods of installing individual components could have taken up to 8 weeks to complete as long as everything was planned and installed correctly.

Off-Site Methods: from the health and safety point of view, it would have placed a great risk on the installers if some of the units were constructed on site. The BIM model helped the site team to analyse the flu system, for example, and a decision was made to make it manufactured rather than built on-site. The flu system was manufactured off-site as requested and installed early on in the schedule using the on-site tower crane.

Clash Detection: the clash detection system was revolutionary. It was carried out by a designated BIM co-ordinator using Navisworks on a daily basis and the findings from the clash detection were reported to the design team. In addition, the BIM co-ordinator on the site was able to seek advice from the construction team as how to best overcome the clash issues. This then gave the design team a potential resolution for clash issues which could have been otherwise overlooked.

In the project over 700 potential clashes were resolved that, otherwise, would have been apparent on-site if they were not designed out using clash detection software.

Communication and Collaborative Design Review: the M+E Design contractor used a management system called “BIM Cave”. The contractor had a large back lit screen (20ft × 10ft) and a video conference suite at their head office. The screen displayed the latest BIM model during the meetings with the whole design team. It was possible to discuss the BIM model and the latest status of the design during the meetings. The system has an interactive whiteboard so that each designer could highlight and annotate the BIM model and discuss design at each meeting.

This enabled each designer with their particular design intent to work together with the other designers on the project rather than eight designers producing eight design ideas. This remote communication tool accompanied by the BIM models revolutionised the way that elements of design were produced and the ways that clashes were resolved through the collaborative design reviews.

The M+E installation continued on site for 8 weeks. When the lower ground floor, ground floor and the first and second floors were completed, there was only one clash realised in 8 weeks. However, in traditional practice with no BIM, the similar M+E installation work would have led to some 50 clashes at least within the same timeline of installation. Thus, the construction management team considered the project as a major success due to the benefits reaped from the BIM usage.

Join the best at the Maastricht University School of Business and Economics!

Top master's programmes

- 33rd place Financial Times worldwide ranking: MSc International Business
- 1st place: MSc International Business
- 1st place: MSc Financial Economics
- 2nd place: MSc Management of Learning
- 2nd place: MSc Economics
- 2nd place: MSc Econometrics and Operations Research
- 2nd place: MSc Global Supply Chain Management and Change

Sources: Keuzegids Master ranking 2013; Elsevier 'Beste Studies' ranking 2012; Financial Times Global Masters in Management ranking 2012

Visit us and find out why we are the best!
Master's Open Day: 22 February 2014

Maastricht University is the best specialist university in the Netherlands (Elsevier)

www.mastersopenday.nl



9.9 Analysis of BIM Usage for the Project Management of Relocation to MediaCity Case Study

Project managers have responsibility for the planning, execution and closing of any project (such as construction projects) which require improvement in terms of cost and time related productivity, efficiency and effectiveness gains. Building Information Modelling (BIM), as a relatively new way of working and methodology, seeks to integrate the building lifecycle in order to provide a safer and more productive environment for its occupants and in order to assert the least possible environmental impact from its existence. It has also been argued that BIM is more operationally efficient for its owners throughout the lifecycle of a building infrastructure.

This case study aimed to explore how BIM can contribute to, and improve, project management. The MediaCityUK project in the city of Salford, UK was the case study. This was a regeneration project expected to attract media institutions both locally and from around the world, thus establishing itself as an international centre for excellence. The University of Salford is the only Higher Education institution which is part of the project possessing offices and spaces within MediaCity. There was a planned relocation by some departments in the University of Salford to the allocated building in MediaCityUK. This move highlighted the need for a well-managed, cost effective and sustainable relocation process. Thus, this study looked at the project management of this relocation project.

In this analysis, firstly, the project management (PM) tasks were identified and documented. A BIM model of the new University office space in MediaCityUK was developed. Finally, the ways in which the BIM model could support each of the PM tasks was identified and discussed. Project Management (PM) as the application of skills, tools and techniques to achieve project requirements (Lewis, 2007) should be considered at the outset of any project as it may fail due to lack of PM commitments at the beginning (Heerkens, 2007).

In scenarios such as a major relocation of organisations into new buildings, PM for relocation and the building lifecycle are key aspects that should be conducted effectively and efficiently. However, there are key challenges in current PM practices such as the determination of the logistics and critical path, preparation of the time plan, documentation and reporting.

Arguably, adopting BIM (Building Information Modelling) is expected to address these PM issues and it is claimed that it has the advantages of providing efficiency and effectiveness for building lifecycle management (Arayici and Aouad, 2011) due to its parametric features, the automated generation of building documentation from the BIM model and the promised information sharing and exchange (Gillard et al., 2008).

This case study, therefore, aimed at exploring and ‘experimenting’ using BIM for PM using the MediaCity regeneration project in Salford Quays in the UK, where the University of Salford was gaining occupancy in a building in MediaCity and was relocating some departments to this new building. The scope was to identify the extent to which BIM contributes to the project management of a relocation project.

9.9.1 Project Management Practices and Key Challenges

Project management is defined as the application of skills, tools and techniques to achieve project requirements in relation to performance, cost, time and scope (Lewis, 2007; Haughey, 2008), for which some key tasks should be conducted diligently such as budget development, establishing goals, logistics, coordination, communication (Packendorff, 1995).

Project management as a discipline is changing. Not only is it about effective planning, monitoring and control, it is also about how it helps in the management of change, adding value to an enterprise, adding to innovation, improved capability, capacities and the competitive advantage of an enterprise. Effective project management should also support effective reporting and documentation.

One of the common difficulties in running a project is a lack of planning and insufficient time being spent at the beginning of a project defining exactly what tasks or duties are to be conducted (Lewis, 2000). Another major issue is that of increasing the scope of the project as time passes (Baker et al., 2003). Time planning in project management depends, to some extent, on the expertise of the project manager. Such expertise is also invariably dependent on the clients’ expected performance level, the cost/available project finance and the scope of the project.

9.9.2 The MediaCity UK Project

MediaCityUK is a purpose-built creative and media development in Salford Quays, Manchester, UK. It aims to bring together companies from across the sector and establish an international centre for excellence in the digital media and creative industries (Wylie, 2007). The University of Salford occupies a building in MediaCity comprising 100,000 sq ft over four floors and this area is linked to the University on the main campus at Peel Park, Salford, UK (Russell, 2009). It was projected that over 4,500 staff and students and some key research and business support units would move to MediaCity. The University’s centre at MediaCityUK includes a broadcast zone, a digital media zone, a virtual laboratory, digital performance space and creative spaces for use in academic teaching, project-based learning and user-centred design and innovation (Russell, 2009).

As a result of the importance of the move by some departments in the University to MediaCity, there was a need to consider this as a project management relocation project (Lewis, 2000) which needed careful and planned processes so as to save time and cost and to minimise adverse environmental and social impacts. Relocation, in this context, involved the movement of light and heavy equipment and furniture to new office spaces in MediaCity. Personnel and students' relocation also took place.



> Apply now

REDEFINE YOUR FUTURE
**AXA GLOBAL GRADUATE
PROGRAM 2015**

redefining / standards 

agence.cdg © Photonistop



9.9.3 Case Study Approach

The aim of the case study was to investigate how BIM could support the effective and efficient project management of a relocation project throughout the duration of the project's lifecycle.

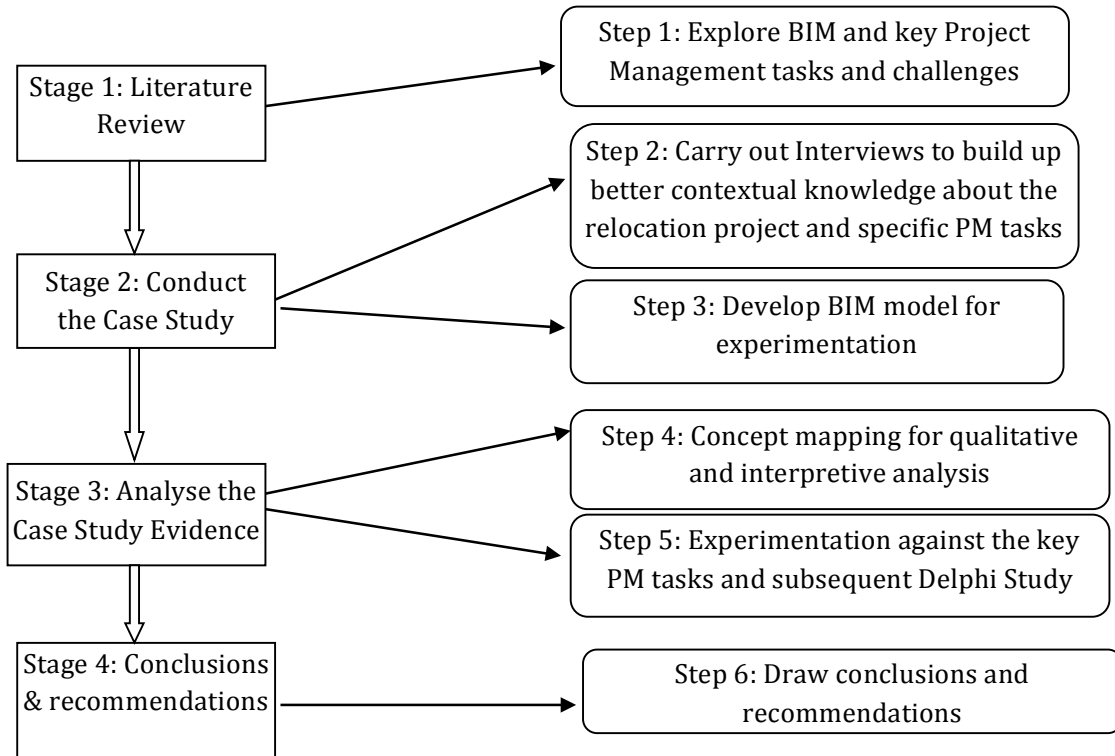

Figure 9.15: The Case Study Protocol

The adopted single case study research method included a literature review, interviews, BIM model development for data collection, concept mapping, BIM modelling and a Delphi study for data analysis. In addition to the literature review findings, interviews with experts helped to finalise which of the key PM tasks were needed and important for the relocation project. Figure 9.15 illustrates the stages of the case study process by considering the construct validity, internal validity, external validity and reliability in the case study.

The next section explains stage two (including step 2 and 3) within the protocol while section 9.8.5 elaborates on stage three (step 4 and 5) and stage 4 is explained in section 9.8.6.

9.9.4 Conducting the Case Study Data Collection – Interviews and BIM Model Development

A semi-structured interview was carried out with an expert in Project Management and two further interviews were carried out with the estate manager of the University and with the MediaCityUK Director who had responsibilities within the University for the MediaCity project. These interviews were to explore and analyse particular perspectives, key tasks and challenges in PM, and to identify the potential benefits of BIM for PM. The interview questions ranged from key tasks and the level of IT applications in PM, difficulties and challenges, to the anticipated benefits and drawbacks of the application of BIM in the project management of the relocation to the MediaCityUK.

The BIM master model of the University building in MediaCity was developed from the architectural and engineering documents such as Architecture, Land Use, Terrain, Utilities, Structure Mechanical Electrical, Transportation and Equipment. The building model data complied with Revit DWG, DXF and IFC interoperable formats. The BIM model has spatial definitions such as: Location Zones, Functional Spaces, Rooms and Places, a form of hierarchical space classification from the largest (building site) to the smallest (places within a room). This helped understanding the spaces within the different floors of the building.

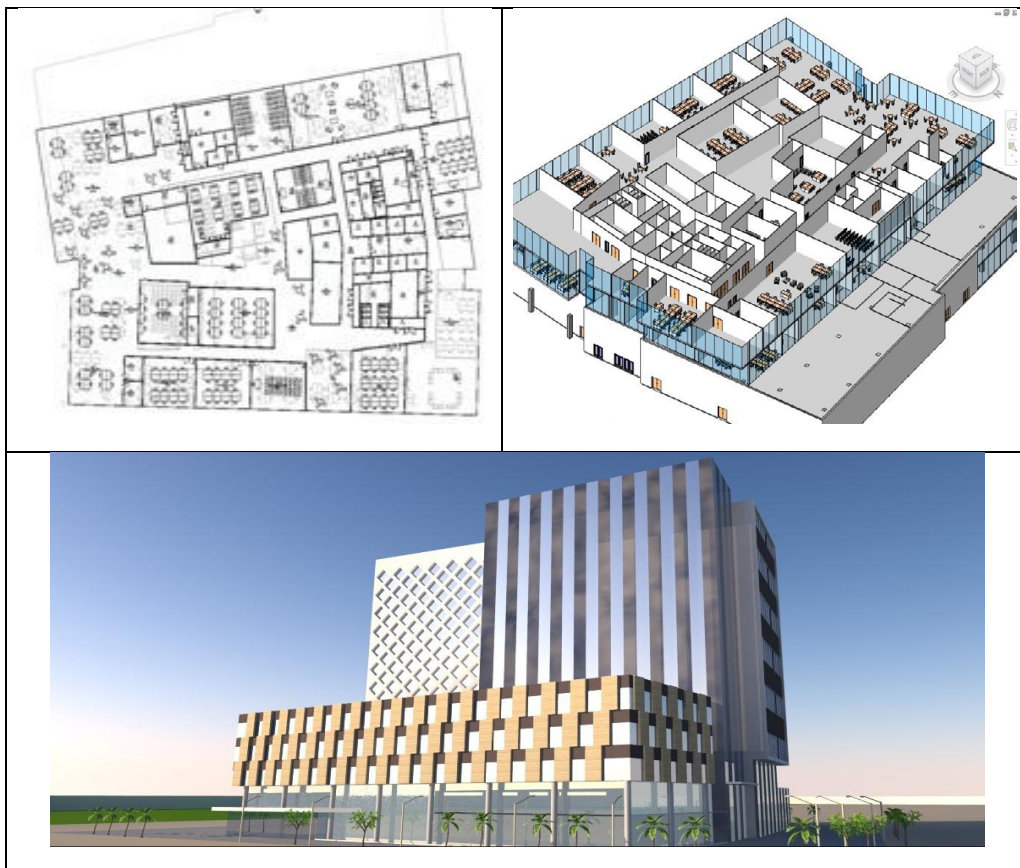

Figure 9.16: 3D and plan views from the BIM model development

As seen in figure 9.16 the developed BIM model is shown from different views within the BIM tool, for example, the image at the top on the left is the 2D view of the floor plans, while the image at the top on the right shows the 3D perspective of an interior view for the third floor and the floors below. The image at the bottom is an exterior perspective view from south east. All these views (and many more in 2D and 3D) can be generated promptly from the BIM model, including elevations and sections at any time.

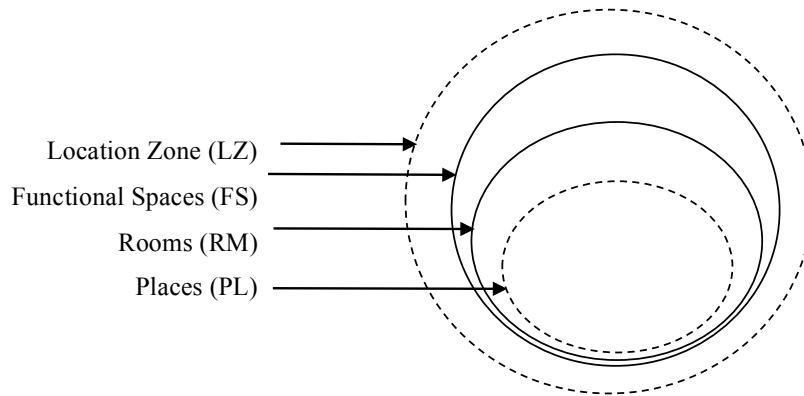

Figure 9.17 Spatial Hierarchy: - LZ: Building position on site, FS: Spaces identified by functions, RM: Wall bounded spaces, PL: Local areas within a room

Table 9.2 was generated automatically from the BIM model, shows the floors of the building from the ground floor up to the 3rd floor that are occupied by the University.

Empowering People. Improving Business.

BI Norwegian Business School is one of Europe's largest business schools welcoming more than 20,000 students. Our programmes provide a stimulating and multi-cultural learning environment with an international outlook ultimately providing students with professional skills to meet the increasing needs of businesses.

BI offers four different two-year, full-time Master of Science (MSc) programmes that are taught entirely in English and have been designed to provide professional skills to meet the increasing need of businesses. The MSc programmes provide a stimulating and multi-cultural learning environment to give you the best platform to launch into your career.

- MSc in Business
- MSc in Financial Economics
- MSc in Strategic Marketing Management
- MSc in Leadership and Organisational Psychology

www.bi.edu/master



Level Code	Meters above	Level Name	Elevation in meters
Level – G	+24.45	Ground Floor Level: <i>University of Salford (Studios, Laboratories and unassigned spaces)</i>	24.45
Level – 01	+28.45	First Floor Level: <i>University of Salford (Studios, Laboratories, offices and unassigned spaces)</i>	28.45
Level – 02	+32.65	Second Floor Level: <i>University of Salford (Studios, Laboratories, offices and unassigned spaces)</i>	32.65
Level – 03	+36.65	Third Floor Level: <i>University of Salford Open plan, exhibition, offices, meeting and multi-function areas</i>	36.65

Table 9.2: Floor settings generated from the BIM model from the ground floor to the 3rd floor

Further, functional spaces are automatically generated in the building from the BIM Model.

FS Code	FS Name	FS Definition
G.18	Living Laboratory	Living laboratory, ceiling, columns, elliptical wall and multi-use area.
G.02	Circulation/Exhibition	Relaxed seating area, access to lifts, green room and stairs to first floor.
1.04	Collaboration Meeting Area	Common open seating area, balusters overlooking ground floor, bridge to studio rooms.
2.21	Vend Breakout	Kitchen, kitchen storage, seating area, resource area.
2.04	Collaborative Space	Relaxed seating area, access to lifts lobby and stairs.
2.08	Open Plan Office	Breakout area, locker storage, columns, curtain walls.
3.26	News Room Workshop	Journalism resource area, relaxed seating area.
3.03	Collaborative Space	Resource area, relaxed seating area, exhibition, access to lifts lobby and stairs.
2.08	Open Plan Office	Breakout area, locker storage, resource storage, columns.

Table 9.3: Functional spaces of the building identified and generated from the BIM model

The schedules of the rooms in the first four floors of the building are also generated from the BIM and illustrated in table 9.4

ID	Types Ground Flr.	ID	Types First Flr.	ID	Types Second Flr.	ID	Types Third Flr.
G.01	University Lift Lobby	1.01	Lift Lobby	2.01		3.01	Lift Lobby
G.02	Circulation/Exhibition	1.02	Circulation Breakout	2.02	Circulation	3.02	Circulation
G.03		1.03	Stair	2.03	Stairs	3.03	Collaborative Space
G.04	Lobby	1.04	Collaboration/MeetingArea	2.04	Collaborative Space	3.04	Breakout area
G.05	Reception	1.05	Ops Management FM Office	2.05	Breakout Area	3.05	Open Plan Office

ID	Types Ground Flr.	ID	Types First Flr.	ID	Types Second Flr.	ID	Types Third Flr.
G.06	-	1.06	Cleaner	2.06		3.06	
G.07	Security	1.07	Bridges	2.07	Pod	3.07	Study
G.08	Mail	1.08	Lobby	2.08	Open Plan Office	3.08	Hot Room
G.09	Primary IT Systems	1.09	Radio Control Room	2.09		3.09	Hot Room
G.10	Exhibition	1.1	Radio Studio A	2.1	Hot Room	3.1	Technician Support
G.11	-	1.11	Radio Studio B	2.11	Hot Room	3.11	Teaching Lab
G.12	Servery	1.12	Sec IT	2.12	Hot Room	3.12	Secondary IT Systems
G.13	Storage/Prep	1.13	TV Control B	2.13	Hot Room	3.13	Lockers/Storage
G.14	House Keeping Storage	1.14	Rack Room	2.14	SecondaryITSystems	3.14	Kitchen
G.15	Furniture Store	1.15	DPL Control Room	2.15	Lockers/Storage	3.15	Exhibition
G.16	Store	1.16	Store	2.16	PC Suite 1	3.16	Vend Breakout
G.17	Green Room	1.17	DPL Lobby	2.17	AV Store	3.17	
G.18	Living Laboratory	1.18	DPL Control Room	2.18	Teaching 3	3.18	Project Room
G.19	DPL Dressing	1.19	DPL Control Room (Sound)	2.19	Dubbing Theatre	3.19	Store
G.20	Media Store	1.2	Lobby	2.2	Music Comp. Suite	3.2	Store
G.21	Lobby	1.21	Lobby	2.21	Vend/Breakout	3.21	Store
G.22	Digital Media Perfor. Lab.	1.22		2.22	Cleaner	3.22	PC Suite 2
G.23	-	1.23		2.23	Teaching Playback	3.23	Meeting 1
G.24	DPL Store	1.24		2.24	Channel M Production	3.24	Multi-Faith Room
G.25	Tech Support Office/IT	1.25		2.25	Edit Suite 1	3.25	Seminar Area for Video Editing Suite
G.26	TV Overspill Store	1.26		2.26	Edit Suite 2	3.26	Newsroom/ Workshop
G.27	Lobby	1.27		2.27	Edit Suite 3	3.27	U.C.M.M.R.L
G.28	TV Studio B	1.28		2.28	Library	3.28	Video Processing Lab.
G.29	TV Studio A	1.29		2.29	ILS Staff	3.29	Hot Room
G.30	TV Studio Store	1.3		2.3	Quiet Study 1	3.3	Hot Room
G.31	-	1.31		2.31	Server	3.31	Teaching 1
2.32	Staff Area	1.32		2.32	SecondaryITSystems	3.32	Teaching 2
				2.33	Meeting 2	3.33	Resource/Storage
				2.34	Teaching 4	3.34	
				2.35	Lecture Room	3.35	Teaching Room
				2.36	Audio Post-Production	3.36	Store
				2.37	Lobby	3.37	

ID	Types Ground Flr.	ID	Types First Flr.	ID	Types Second Flr.	ID	Types Third Flr.
				2.38	Sound Booth	3.38	Video Editing Suite
				2.39	Technician Support	3.39	Control Room
				2.4	Lobby	3.4	Msc Student Space
				2.41	Media Tech Lab	3.41	Future Expansion
				2.42	Store	3.42	Computer Teaching Area
				2.43	Store	3.43	Cleaner
				2.44	Kitchen	3.44	Live Booth
				2.45	Store	3.45	Teaching Office
				2.46	Lobby	3.46	
				2.47	Quiet Study 2	3.47	Control Room
				2.48	<i>ILS Resource Area</i>	3.48	
				2.49	Meeting 3	3.49	
				2.5	Meeting 4	3.5	

Table 9.4: The room schedule of the building for the first four floors

As spaces for the University of Salford are located in the first four floors of the MediaCity building, the spatial analysis was only carried out for these floors.

Need help with your dissertation?

Get in-depth feedback & advice from experts in your topic area. Find out what you can do to improve the quality of your dissertation!

Get Help Now

Go to www.helpmyassignment.co.uk for more info



9.9.5 Analysis of the Case Study Evidence

This section discusses the findings from the interviews and the BIM model development via concept mapping. The benefits of using BIM in conducting PM tasks were analysed and interpreted via the Delphi study.

9.9.5.1 Project Management Considerations for Relocation

The interview with the expert in PM revealed a holistic approach to the relocation process by identifying tacit concerns, in terms of project management, such as disruption to the work flow of staff and space size requirements for the different departments involved in the move. Also mentioned were areas such as the transportation of staff and students in terms of safety and shuttling between lecture halls in the main and MediaCityUK campuses.

From the concept map in Figure 9.18, it is noted that some issues such as the tools that are used to carry out PM functions could be applied in the relocation project such as Primavera and Microsoft for critical path analysis and Microsoft Excel for bar charts. The interviewee emphasised that BIM is, however, viewed differently by different industry professionals. Some view it as a basic tool for basic functions, while some view it as a key tool that can greatly enhance production in the construction industry. However, it was concluded from the interview that BIM could contribute greatly in carrying out and assisting numerous PM tasks such as planning, monitoring, decision making and risk management. Major considerations that arose from the interview in relation to the PM of the relocation project included the relocation process, PM methods and functions (including the ones that can have impact on the relocation process), physical infrastructure, and the use of BIM for PM.

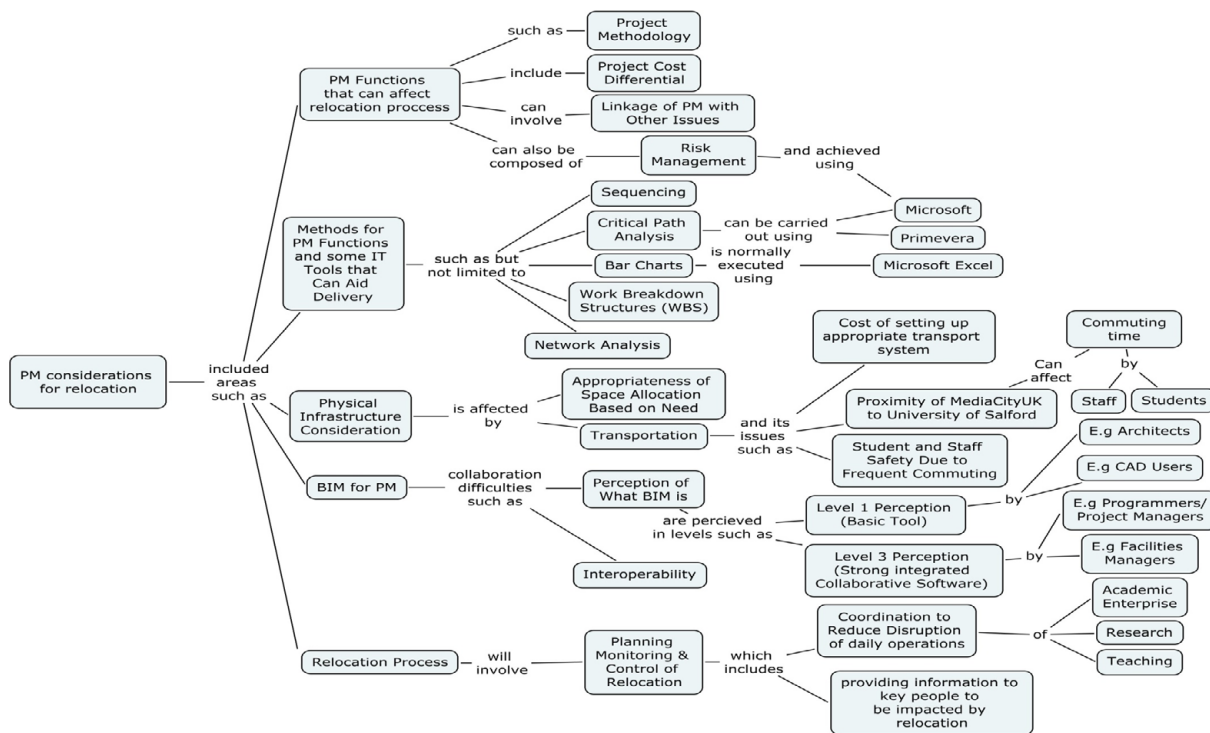

Figure 9.18: The Concept Map capturing related issues of PM

The interviewee, while commenting on the relocation process, highlighted that planning, monitoring and control apply to the management of the relocation process. According to the interviewee, the unique nature of the relocating institution (the University of Salford) required a high level of coordination was adopted to reduce disruption of daily operations and activities such as teaching, research and academic enterprise. Added to this, owing to the nature of some of the University activities (e.g. collaborative research activities), possible fragmentation might have occurred during the move which could compromise collaborative efficiency. As a result, the interviewee asserted that, in order to provide efficient PM for this relocation, the key people, who would be directly impacted upon by the relocation, had to be informed and given a long lead time.

The interviewee also drew attention to the physical infrastructure, namely, the demand on the physical spaces and the potential allocation of the new MediaCityUK space to satisfy the requirements of individual schools/departments. In order to be operational effectively, it was possible that some schools might have needed larger space than the space originally allocated in the new building. This could subsequently have led to reduced productivity due to insufficient allocated space. Another PM issue pointed out by the interviewee was that of transportation and related issues such as safety due to the distance to the new property from the main campus. However, it was suggested that alerting the authorities of the need to create safer alternative transportation would have ensured the mitigation of the potential transportation hazard. The interviewee also described MediaCityUK as an iconic project which attracts a high level interest from outside and media scrutiny.

When asked about the tools and methods used to fulfil PM functions, the interviewee gave a list of traditional PM techniques and approaches including Sequencing, Work breakdown structures, Critical path analysis, Network analysis and Bar charts. When asked further about possible IT tools that could catalyse delivery on the aforementioned techniques, the interviewee pointed out that there are different IT packages for different tasks. The following were listed by the interviewee: (a) Critical path analysis can be carried out using Microsoft project, Primavera, (b) Risk management using Monte Carlo Simulation, “At Risk”, (c) Project Methodology can be carried out using Prince 2 (Projects in controlled environment), (d) Project cost differential using n value analysis and Project information management systems (PIMS), (e) Linkage of PM with object oriented issues within a particular project can be carried out using BIM.

The interviewee pointed out that there might be conflicting views on whether to use a BIM tool or a traditional alternative. When the decision to adopt a BIM tool is made, the need for capacity, and a capability improvement to use the software, arises. User training on BIM could be both cost and time demanding.



Brain power

By 2020, wind could provide one-tenth of our planet's electricity needs. Already today, SKF's innovative know-how is crucial to running a large proportion of the world's wind turbines.

Up to 25 % of the generating costs relate to maintenance. These can be reduced dramatically thanks to our systems for on-line condition monitoring and automatic lubrication. We help make it more economical to create cleaner, cheaper energy out of thin air.

By sharing our experience, expertise, and creativity, industries can boost performance beyond expectations. Therefore we need the best employees who can meet this challenge!

The Power of Knowledge Engineering

Plug into The Power of Knowledge Engineering.
Visit us at www.skf.com/knowledge

SKF

Download free eBooks at bookboon.com



Click on the ad to read more

Another potential problem, according to the interviewee, is that of interoperability. The interviewee also conveyed the various perceptions and understandings of BIM by users. For example, some see it at level one: a basic tool, while some others see it at level three: a strong integrated and collaborative tool that actually helps in streamlining processes and in increasing efficiency. According to the interviewee, professionals who use CAD might claim that they are using part of BIM, whereas those who use it at a strategic level by bringing people together such as project managers see BIM as a means of integrating people in collaboration from discrete locations. That is to say, architects see BIM as part of the design process, whilst programmers see BIM differently because it helps them in sequencing in project management and they are not interested in the design aspects. On the other hand, facilities managers see BIM as being supportive and allowing them to articulate exactly what would happen after 'this' movement via "what-if" analysis such as: What will be the true lifecycle of the building? How can space use be monitored (soft issues)? How can maintenance (hard Issues) be undertaken? How electricity/energy use be maximised?

9.9.5.2 An Insight into the Relocation Project with BIM

Two further interviews were conducted, one with the estate manager of the University and the other one with the MediaCity Director; these allowed for the gathering of useful information on the required PM strategy for the move. The choices of an extension of the existing facilities' services on the main campus to MediaCityUK or the provision of a different services' model for the new facility in MediaCity were elaborated upon in the interviews. In the interviews, an insight into the PM of this relocation project with BIM was elaborated. PM tasks such as scheduling and move logistics were explored.

The estate manager interviewed acknowledged that he had not had hands-on involvement with the IT aspects of estate management but that he oversaw a small team in that area. He was, however, content that BIM can provide benefits and efficiency gains for the PM of the relocation project when the BIM model was demonstrated to the interviewee during the interview, this being on the premise that the BIM model incorporates the right information required for the PM.

Varying views and experiences with regard to the possible challenges and the possible BIM benefits to the PM of the relocation project to MediaCity were revealed from the interviews. For example, the extent of the PM tasks in the relocation project was made clear by the interviewees; one of them being the advance notification to the building users which can help in the minimisation of disruptions during the relocation. While there are benefits (such as building lifecycle management, accurate data, time and cost savings as a result of high level coordination, reduced time for project completion, and minimising disruptive activities), there are also challenges such as a lack of available BIM skills and capabilities, varying user perceptions, interoperability issues, and so on.

From the best practice projects looked at and the interviews conducted, it has become clear that a BIM model can offer benefits to the project management of a relocation project. However, the choice of adopting BIM for PM still requires that project managers gain a level of awareness of its added benefits over the status quo. The interviewees raised the issues of user knowledge and capacity building for BIM adoption in PM, which should not be overlooked. Thus, the need to assess the potential holistic cost of adopting a BIM tool should incorporate the cost of user training. However, all the interviewees agreed that BIM technology presents a valid potential for obtaining cost savings within PM activities as long as the data is accurate and well maintained.

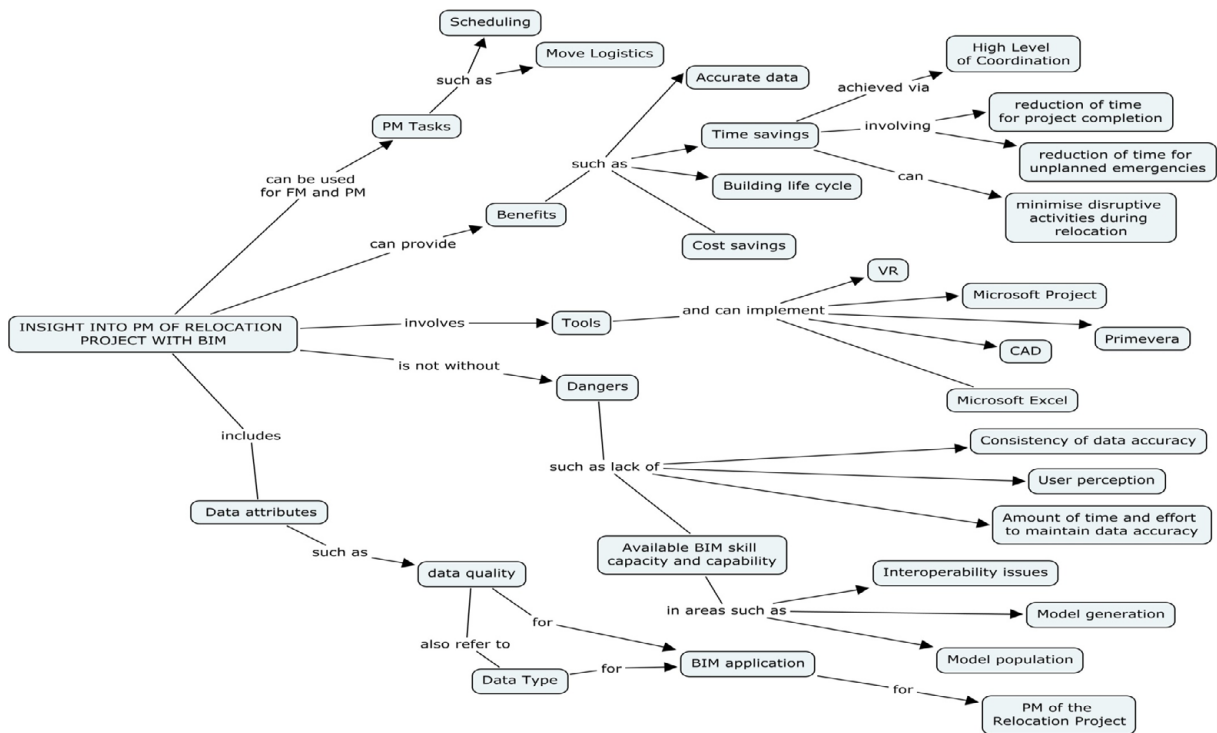

Figure 9.19: The Concept Map depicting an insight into the relocation project utilising BIM

9.9.6 BIM Model Experimentation for the Project Management of the Relocation to MediaCityUK

Experimentation, as used in this study, applies to the use of a BIM model in conducting specified PM tasks and the benefits and efficiency gains observed for each of the PM tasks as elaborated and interpreted by the members of the Delphi study. BIM experimentation in this study was used to test the BIM model of the University building in MediaCity which was produced as an architectural model describing the digital model of MediaCity, which helped to understand the spatial hierarchy that is made up of the location zone, functional spaces, rooms and places (for example, rooms are bounded spaces while places are ‘the child of a room’ and the location zone was the building position on site).

Development of the BIM model of the MediaCity building started with the MediaCity master model development, which was then followed by the development of the sub-models by using Revit Architecture. This development was carried out by taking into consideration the BIM data requirements. The BIM model consisted of building elements (walls, doors, windows, etc.), building services (transportation and electrical), furniture on each storey and fire compartments and fire zones.

The BIM model revealed a zoning character which was mirrored in the ground and first floor. The central east/west axis on the plan view was reinforced with the studio functional spaces (TV studio B, TV studio store and TV studio A), and to the north were living spaces and to the south an open plan area.

The studios were designed to have “double volumes” extending to the first floor. The double volume extension and the studio function of these spaces indicated that there would be light/heavy studio equipment/furniture that could affect the PM scheduling of access into TV studio A and TV studio B. Major access into the building was limited to the ground floor east, west and north sides; this became an important factor when scheduling the movement of furniture into the open plan area. However, the BIM model revealed that the open plan area could be populated but each item had to be dismantled to the size of the minimum door dimension to fit through the primary and secondary access double doors.



“I studied English for 16 years but...
...I finally learned to speak it in just six lessons”
Jane, Chinese architect

ENGLISH OUT THERE

Click to hear me talking before and after my unique course download



Areas like the north-east part of the BIM model on the ground floor (that is an open area with a Living Laboratory and an exhibition area) have a height that extends to the first floor (which resembles a mezzanine floor). There is a foot bridge from the mezzanine floor to the east/west axis of the building. This area required accurate programming to populate with it with furniture and a good knowledge of the electrical points was crucial as increased human traffic was expected within this space.

On the second and third floors, the furniture distribution density shown in the BIM model based on drawings, were significantly higher than that in the ground and first floors. This suggested a significant amount of vertical transport. The contributions of BIM to the PM of the relocation project are further analysed by the Delphi Study based on the BIM experimentation. In the following sub-section, the experimentation and the analysis of BIM usage for PM is elaborated against the key PM tasks.

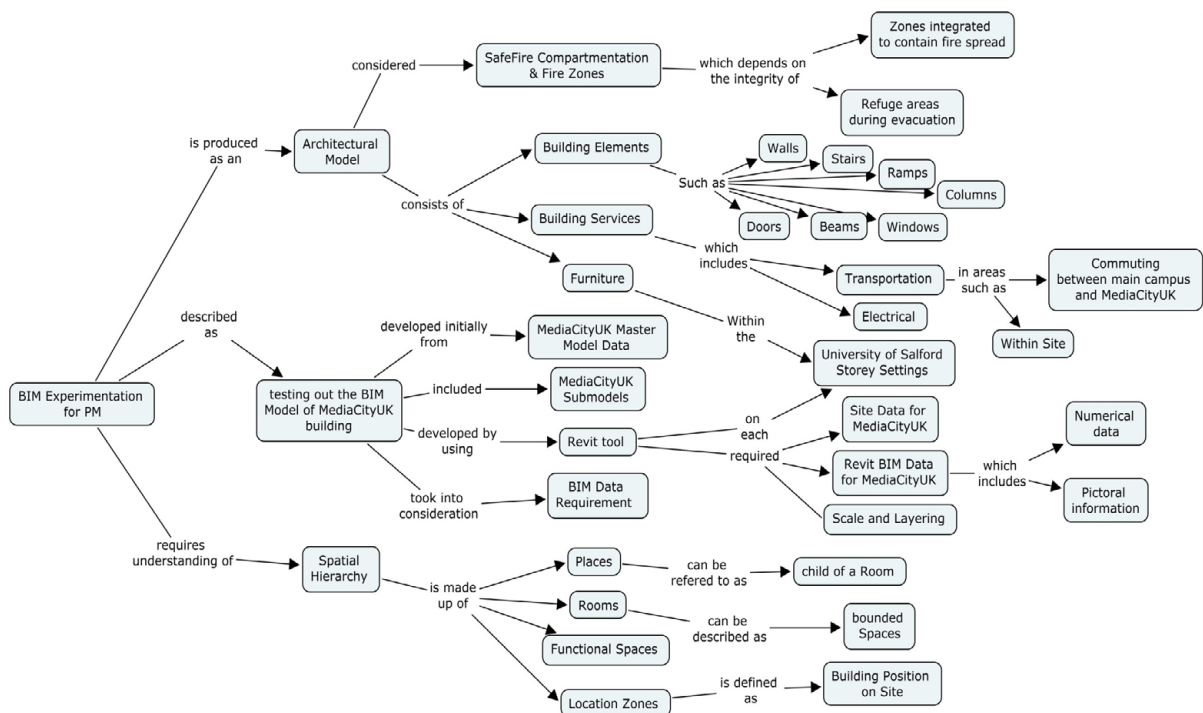

Figure 9.20: Concept map illustrating the key issues in the BIM experimentation

PM Task 1: Establishing Goals

The process of relocation to the MediaCityUK building will require goals to be established especially because of the complexities associated with the tasks involved in the relocation. To establish these goals, updated, comprehensive and coordinated information about the building is required. To some extent, the basic information can be acquired from the CAD drawings and the specification documents. However, in order to avoid or minimise any disruption of activities, to save time and reduce cost, to avoid health and safety issues during the relocation, updated comprehensive and coordinated information for planning and scheduling can be obtained from the BIM model which provides a wealth of information. The BIM model reflects real-time input from the stakeholders.

PM Task 2: Development and Confirmation of Budget

The amount of money that is to be allocated in the relocation process is important. The BIM model has a schedule of all the elements which is automatically generated. The BIM model can also generate schedules of furnishings. 2D or 3D CAD cannot provide such information simultaneously and as accurately as the BIM model. This is because the 2D drawings in most cases require a separate specification or schedule document which cannot be updated simultaneously. Further, a 3D CAD model cannot have building elements represented in properties and quantities.

During the relocation process, the routes to the various storeys in the building, to the object spaces and places are important as this will determine the internal transport approach to furniture movement (which can be costly). As the MediaCityUK BIM model shows the layout of the building, it is easier to select the most cost effective and time saving internal transport approach.

PM Task 3: Preparation of Responsibility Matrix

During the relocation process, different roles/responsibilities are involved. It is important that these activities are coordinated with a clearly defined role for each contractor. This can be achieved by merely analysing the non-BIM contract documents. The BIM model, however, enables the project manager to assess the actual work type required for the move using the 3D model of the BIM's accurate element furniture representations.

PM Task 4: Development of RFPs (request for proposals) for Vendor Participation

The information provided by the MediaCityUK BIM model can help create more accurate RFPs due to the automated generation of documentation by the BIM model for different requests and requirements.

PM Task 5: Determination of Move Logistics and Critical Path

The MediaCityUK BIM model developed is limited to the building structure (which includes external access and exits along its perimeter wall) because the site was not modelled because of a lack of accurate site information for BIM modelling. The move logistics into the building can be determined by analysing functional space, room and place data within the BIM model. Due to the comprehensive information content of the BIM model, the sequence of relocation activities (critical path) can be determined.

PM Task 6: Generation of Furniture Inventory Database and Preparation and Confirmation of Move Matrix

The crucial elements required to generate a move matrix (including the furniture inventory which is provided by the BIM model) include the following:

- Sizes of furniture and building access routes
- Types of furniture
- Vertical transport of furniture
- Horizontal transport of furniture
- Positions of electrical fittings
- Sizes (width and height) of non-access openings
- Building fabric data



What do you want to do?

No matter what you want out of your future career, an employer with a broad range of operations in a load of countries will always be the ticket. Working within the Volvo Group means more than 100,000 friends and colleagues in more than 185 countries all over the world. We offer graduates great career opportunities – check out the Career section at our web site www.volvogroup.com. We look forward to getting to know you!

VOLVO
AB Volvo (publ)
www.volvogroup.com

VOLVO TRUCKS | RENAULT TRUCKS | MACK TRUCKS | VOLVO BUSES | VOLVO CONSTRUCTION EQUIPMENT | VOLVO PENTA | VOLVO AERO | VOLVO IT
VOLVO FINANCIAL SERVICES | VOLVO 3P | VOLVO POWERTRAIN | VOLVO PARTS | VOLVO TECHNOLOGY | VOLVO LOGISTICS | BUSINESS AREA ASIA



PM Task 7: Preparation of Time Plan

The BIM model contains information on the types and sizes of all the spaces within the structure, the access routes to each of these spaces, the building elements and the furniture schedules and quantities. Thus, with this information, it becomes easier to prepare a time plan for the relocation process.

PM Task 8: Review of Construction Documents for the Relocation

Gathering construction documents from different participating industry professionals can require time and also the synchronised interpretation of the 2D information, and can result in interpretation errors due to the high number of documents and duplications. In addition, sometimes the as-built drawings are not accurate representations of the original drawings with regards to specification and building dimensions. This was also highlighted by the interviewee who was an expert in IT as discrepancies were observed in the drawings used for 3D VR (virtual reality) production. On the other hand, the BIM model reflects accurately the as-built information for interoperable reasons with regards to input from the participating stakeholders due to a highly accurate as-built representation by the BIM model.

PM Task 9: Preparation of Move Packet

Information from the BIM model can be used to prepare a move packet. How it is used will depend on the project manager's move strategy and objectives.

PM Task 10: Coordination of Vendors

Vendor coordination is important and so is the coordination of the movement of the users (student and staff). The capability of the BIM model to create schedules which are linked to the model makes it easier to coordinate vendors.

PM Task 11: Provision of On-site Coordination and Supervision of all Move Related Vendors

On-site coordination of the relocation is one of the ways BIM can enhance the project management of a relocation project. As a replica of the real building, the BIM model contains all the desired positions of furniture and equipment. Also, it shows the access routes both in direction and dimension. Therefore, it is easier to ensure that the right furniture or equipment is positioned in the right functional space, room or place. In addition, the sequence of the placements can be coordinated and move related vendors supervised from the scheduling capability of the BIM model.

PM Task 12: Addressing Surplus Items

It becomes easier to identify surplus items or even avoid having them due to the accuracy and timely generation of the quantity of building items and schedules provided by the BIM model.

PM Task 13: Implementation of Service and Technology Bridging

The IT facilities in the MediaCityUK actual building was not represented in the BIM model as this information was not available for BIM modelling. As a result, it is not immediately evident how the BIM model can contribute to this area during the relocation process. However, if the BIM model developed is populated with the proposed or existing IT network of the building, then the BIM model may provide some benefits in this regard.

9.9.7 Discussion

The case study explored how BIM can support the effective and efficient project management of a relocation project. It showed that BIM can offer real support in the management of tasks associated with a relocation project, for example, the instant walkthroughs generated from the BIM model assist the PM in having a virtual tour of the building to visually assess key considerations during relocation. Furthermore, automated generation of the quantities of building items and the scheduling capability of BIM helps in setting cost and time targets such as the development and confirmation of budgets. BIM modelling also provides detailed information on the number and types of furniture to be moved and other cost intensive decision making considerations such as work breakdown structures, critical path analysis and execution, and preparation of a responsibility matrix.

The BIM model as a prototype of the actual building provides information which, inter alia, includes equipment, furniture, access routes within the building, and safety systems that will enable the virtual execution of the project; hence a responsibility matrix can be prepared prior to the actual execution of the relocation project. Its usefulness also has a positive impact on the accurate determination of the project scope, on the illustration of expected performance level, and it enables the stakeholders or clients to determine the desired performance level and/or scope of the project. Furthermore, the cost of the determined performance level and scope for the project can also be reproduced in real-time by BIM with proper quantity input which will assist stakeholders in balancing the desired performance level and to scope against available funds for the project.

The use of BIM for the maintenance operations of the MediaCityUK building will depend on how the model is populated, the available information on electrical, M&E and machinery/plant issues within the model, and how this information in the model is maintained over time. In such a case, the BIM model serves as the virtual replica of the building with important information on the maintenance histories of each component within the building. In the event of a maintenance problem (e.g. in the plumbing system), the BIM model can provide visual information on the location of the fixture, how the fixture relates to other fixtures and the building as a whole, and where the fixture type has been used in other areas of the building in order to inspect for potential damage. Such information makes it easier for the facilities management (FM) team to identify and rectify any issues. The benefits obtained by BIM in this regard are dependent on the type, quantity and quality of information within the model. However, it will not be economically viable to adopt such a BIM approach for relatively small projects as such an approach requires high quality information. Also, extensive training of its users may be required which can compromise the time and cost savings obtained from BIM usage.

Overall, the MediaCityUK building is made up of open plan areas/functional spaces, closed spaces/rooms and spaces which extend vertically to the next floor/voids. In a 2D representation, these spaces can become difficult to understand and articulate with regards to their designated use. With ordinary 3D CAD representations, the spaces can be visually appreciated with no specification details and quantities attached.

gaiteye[®]
Challenge the way we run

**EXPERIENCE THE POWER OF
FULL ENGAGEMENT...**

**RUN FASTER.
RUN LONGER..
RUN EASIER...**

**READ MORE & PRE-ORDER TODAY
WWW.GAITEYE.COM**



9.10 References

Arayici, Y., Aoaud, G. (2011), “Building information modelling (BIM) for Construction Lifecycle Management” Chapter 4 In *Construction and Building: Design, Materials, and Techniques* edited by Sophie G. Doyle, pp. 99–118, Nova Science Publishers, NY, USA, ISBN: 978-1-61761-211-4.

Baker, S., Baker K. and Campbell, M. (2003), “The Complete Idiot’s Guide to Project Management”, 3rd Edition, Penguin Group (USA) Inc.

Haughey, D. (2008), “An Introduction to Project Management”, Project Smart www.projectsart.co.uk/ [Accessed March 2011].

Heerkens, G. (2007), “Project Management, 24 steps to help you Master any Project”, The McGraw Hill Companies.

Lewis, P.J. (2007), “Fundamentals of Project Management”, 3rd ed, AMACOM Books, New York.

Lewis, P.J. (2000), “The Project Managers Desk Reference, 2nd Edition”, The McGraw Hill Companies.

Packendorff, J. (1995), “Inquiring into the Temporary Organisation: New Directions for Project Management Research”, *Scand. J. Management*, 11 (4), 319–333.

Russell, (2009), “BBC Signs MediaCity UK Deal” <http://www.business-services.salford.ac.uk/cms/news/article/?id>, [Accessed March 2010].

Wylie, I. (2007), “First view of the BBC Media City”, *Manchester Evening News*, http://menmedia.co.uk/news/s/237141_first_view_of_the_bbc_media_city [Accessed March 2010].